

UK SHORT FORM CATALOGUE

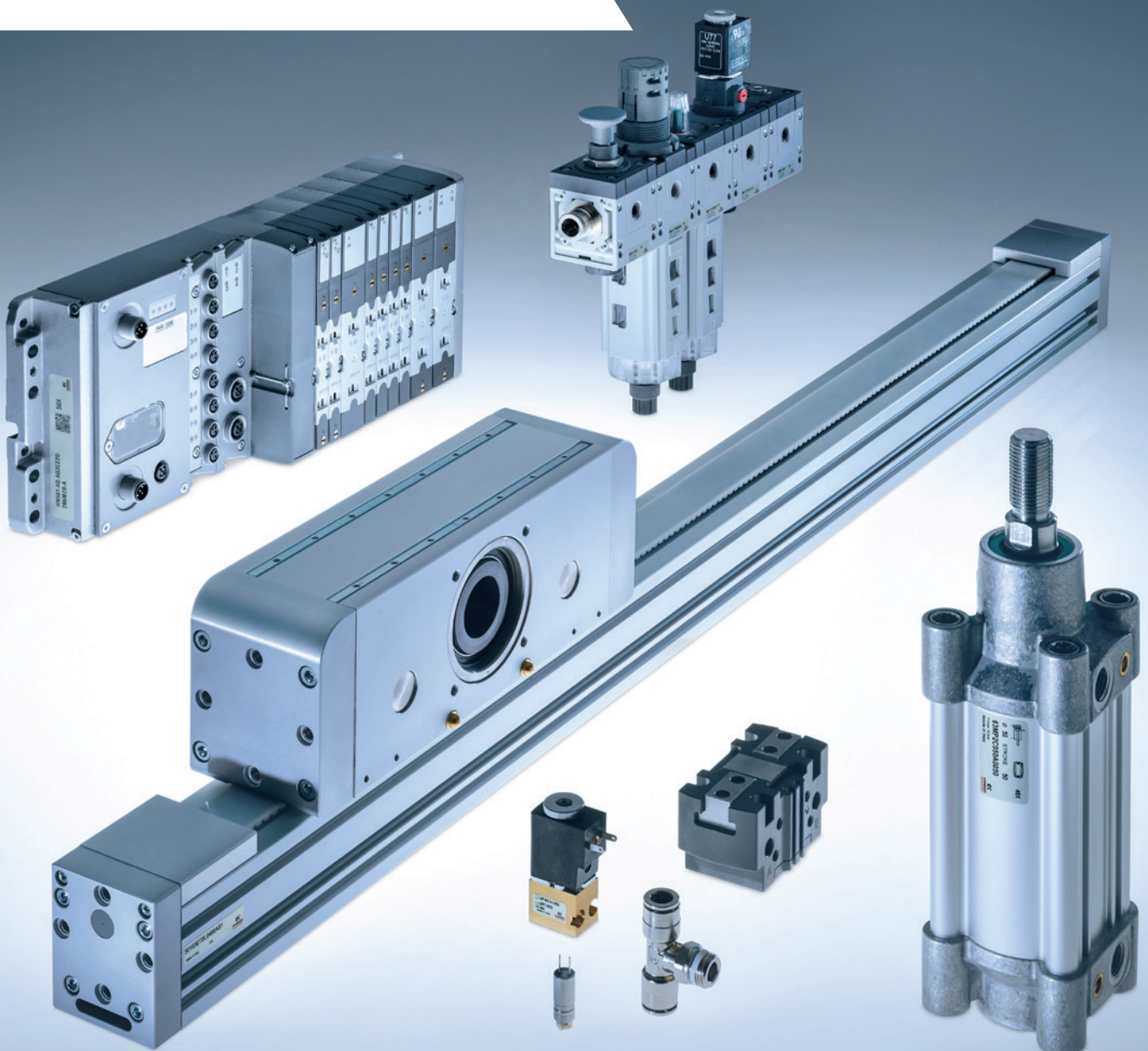

WELCOME TO CAMOZZI AUTOMATION

Camozzi Automation offers a full range of products including components, systems and technologies for the industrial automation sector, the control of fluids -both liquids and gases - and for applications dedicated to the transportation and life science industries.

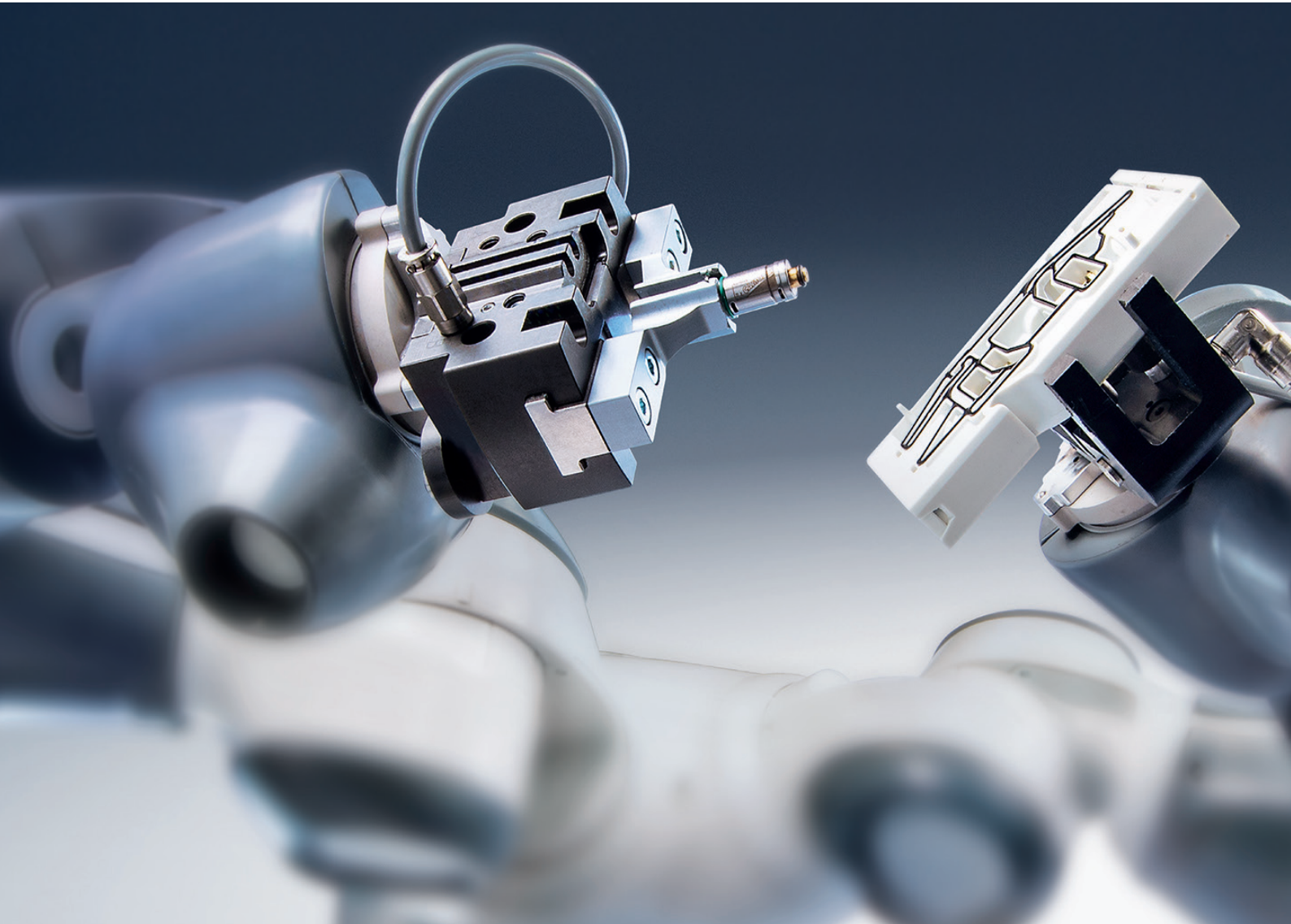

Contact

Camozzi Automation Ltd
The Fluid Power Centre
Watling Street
Nuneaton
Warwickshire
CV11 6BQ
United Kingdom
+44(0) 24 7637 4114
askus@camozzi.co.uk
www.camozzi.co.uk
store.camozzi.co.uk

Pneumatic Actuation

1



- 3 International Standard Cylinders
- 20 Compact Cylinders
- 28 Stainless Steel Cylinders
- 29 Guided Cylinders
- 33 Non Standard Cylinders
- 38 Rotary Cylinders
- 40 Rodless Cylinders
- 45 Proximity Switches
- 48 Additional Cylinder Accessories

Pneumatic Connection

252



- 254 Super-Rapid Fittings
- 266 Rapid Fittings
- 270 Universal Fittings
- 271 Fittings Accessories
- 277 Quick-Release Couplings
- 279 Air Brake Fittings
- 283 Tube Cutters and Accessories

Electric Actuation

52



- 53 Electromechanical Cylinders
- 56 Electromechanical Axes
- 60 Drives
- 61 Motors

Ball Valves and Non Return Valves

284



- 285 Brass Two-Way Ball Valves (Premium)
- 287 Stainless Steel Two-Way Ball Valves
- 288 Stainless Steel Three-Way Ball Valves
- 289 Direct Mount Ball Valves (for actuation)
- 291 Exhausting Brass Ball Valves
- 293 Brass Three-Way Ball Valves
- 294 Non-Return Valves

Handling and Vacuum

64



- 65 Grippers
- 67 Suction Pads
- 67 Ejectors
- 68 Vacuum Accessories
- 68 Vacuum Filters

Process Valves and Actuation

296



- 297 Butterfly Valves
- 299 Actuated Two-Way Ball Valves
- 303 Actuated Three-Way Ball Valves
- 305 Industrial Solenoid Valves
- 314 Accessories

Valves and Solenoid Valves

69



- 71 Directly and Indirectly Operated 2/2, 3/2 Solenoid Valves
- 77 Solenoid, Pneumatic and Manifold Valves
- 138 Mechanical and Manual Valves
- 158 Logic Valves
- 160 Automatic Valves
- 163 Flow Control Valves
- 173 Silencers

Hydraulic Couplings

316



- 317 Flat Face Couplings - ISO 16028
- 322 Quick Release Couplings - ISO A Norm
- 327 Quick Release Couplings - ISO B Norm
- 330 Screw Couplings
- 331 Agricultural Coupling Trailer Brake

Fieldbus and Multipole Systems

174

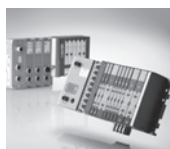

- 175 Valve Islands

Hydraulic Valves & Accessories

332



- 333 Hydraulic Ball Valves
- 336 Actuated Ball Valves
- 338 Accessories

Proportional Technology

194



- 195 Proportional Valves
- 196 Proportional Regulators

Tubing

342



- 343 Nylon
- 346 PVC Hose
- 348 Pneumatic Polyurethane Tubing
- 349 PTFE Tubing
- 349 Accessories

Air Treatment

199



- 202 Series MX Modular FRL Units
- 216 Series MC Modular FRL Units
- 227 Series MD Modular FRL Units
- 239 Series N FRL Units
- 242 Pressure Regulators
- 245 Pressure Switches and Vacuum Switches
- 249 Accessories for Air Treatment

Appendix

350

- Symbols
- Spring Loads Cylinders
- Flow and Speed Cylinders
- Output Force Double- Acting Cylinders
- Table Showing Air Consumption of Double-Acting Cylinders
- Quality: Our Priority Commitment
- Information for the use of Camozzi Products
- Directive ATEX 2014/34/EU

CAMOZZI AUTOMATION

YOUR BEST CHOICE FOR MULTI-TECHNOLOGY SOLUTIONS

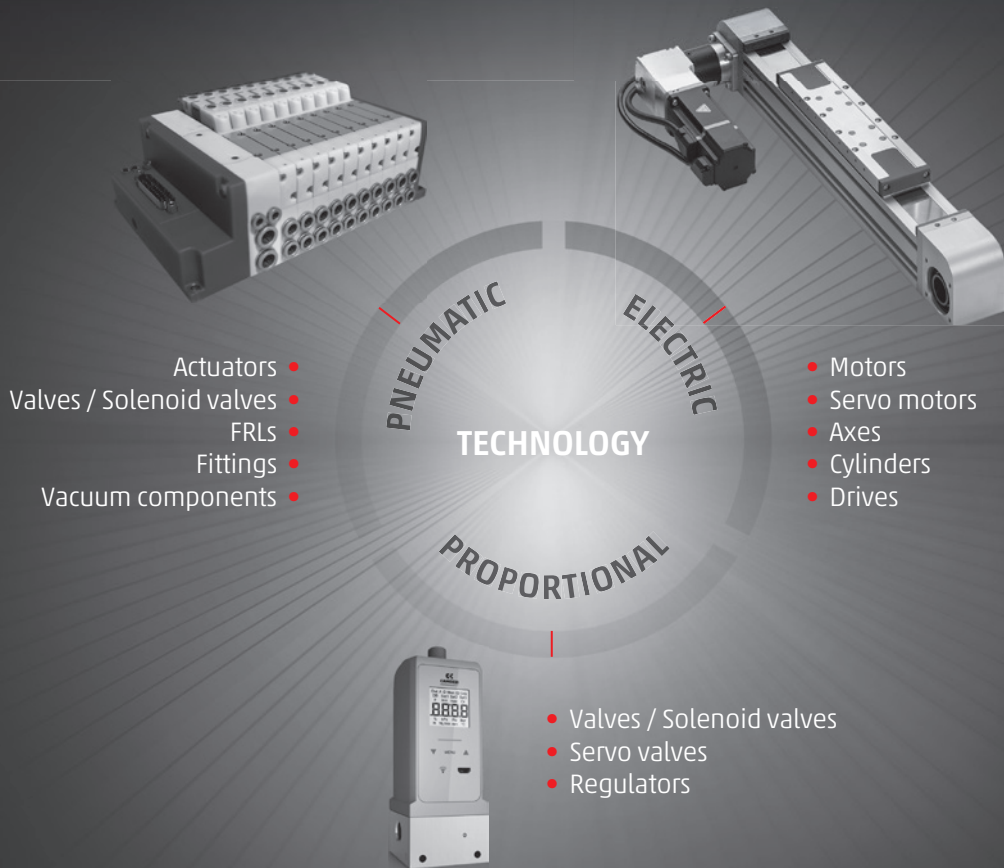

More than just pneumatics

Camozzi's multi-technological approach makes it possible to offer an optimal solution for every application by choosing from the best pneumatic, electric and proportional technologies available.

This process requires a depth of expertise that not only addresses both the characteristics of technologies and products, but also considers the functional requirements of the end application.



INDUSTRIAL AUTOMATION



LIFE SCIENCE



TRANSPORTATION

Ordering and General Information

Delivery

We can supply any core product ordered between 8.30am and 5.30pm on a next day basis. Optional next day deliveries before 10am or timed next day deliveries available on request.



Camozzi UK

Camozzi's distribution network with over 50 outlets throughout the UK and Ireland offers our customers unrivalled service and support.



Same Day Cylinder Service

We offer a same day cylinder service, including standard and non standard strokes. Please call the Camozzi sales office for more information.



Camozzi Worldwide

Camozzi is one of the world's leading suppliers of advanced pneumatic components and systems with representation in over 70 countries. Catalogues can be supplied in a range of different languages upon request.



Additional Services

In addition to individual components, Camozzi can supply complete bespoke solutions.



Training

Camozzi UK has its own purpose-built on-site training suite offering an expanding range of courses.



Warranty

A comprehensive one-year warranty applies to all Camozzi products, subject to our standard conditions of sale (available on request).

ISO Certification

Camozzi is certified in accordance with ISO 9001 and ISO 14001.

Technical Catalogue

A comprehensive range of product literature is available in hard copy or online (catalogue.camozzi.com). A full technical catalogue for design engineers can be requested by contacting the sales office.

Terms & Conditions

We have made every effort to ensure that product information in this catalogue is accurate. However, the company reserves the right to vary models and dimensions and to amend prices without notification. Returns are not accepted without prior written approval from the company (refer to page 365). Full terms and conditions available on request.

UK Online Store



Request an account today

- Instantly check price and availability
- Download product datasheets
- Place orders whenever it suits you





<https://store.camozzi.co.uk>

Pneumatic Actuation

1 International Standard Cylinders

	Page
 <p>Series 16, 23, 24, 25 Mini-Cylinders CETOP RP52-P / DIN/ISO 6432</p>	3
 <p>Series 40 Cylinders ISO 15552 DIN/ISO 6431/VDMA 24562</p>	5
 <p>Series 41 Cylinders - Aluminium Profile DIN/ISO 6431/VDMA 24562</p>	7
 <p>Series 61 Cylinders - Aluminium Profile CETOP RP52-P / DIN/ISO 6432</p>	9
 <p>Series 63 Cylinders - Aluminium Tube and Profile ISO 15552 DIN/ISO 6431/VDMA 24562</p>	12
 <p>Series 32 Compact Magnetic Cylinders ISO 21287</p>	16
 <p>Series 45 Anti-Rotation Guide Units</p>	19



2 Compact Cylinders

	Page
 <p>Series QN Short-Stroke Cylinders</p>	20
 <p>Series QP, QPR Short-Stroke Cylinders</p>	21
 <p>Series 31 Compact Cylinders</p>	23
 <p>Series ST Stopper Cylinders</p>	26

3 Stainless Steel Cylinders

	Page
 <p>Series 90, 94, 95, 97 Stainless Steel Cylinders</p>	28



4 Guided Cylinders

	Page
 <p>Series QCT, QCB Cylinders with Integrated Guide</p>	29
 <p>Series QCTF, QCBF Cylinders with Integrated Guide</p>	30
 <p>Series QX Twin Cylinders</p>	31



5 Non-Standard Cylinders

	Page
 <p>Series 14 Compact Mini-Cylinders</p>	33
 <p>Series 27 Roundline Cylinders</p>	34
 <p>Series 42 Cylinders</p>	36



6 Rotary Cylinders

	Page
 <p>Series 69 Rotary Cylinders</p>	38
 <p>Series 30 Rotary Cylinders</p>	39





7 Rodless Cylinders

	Page
 <p>Series 50 Rodless Cylinders</p>	40
 <p>Series 52 Rodless Cylinders</p>	42

8 Proximity Switches

	Page
 <p>Series SKR - CSV - CSB - CSC Magnetic Proximity Switches</p>	45
 <p>Series SF - S-CST - SZR12 Magnetic Proximity Brackets</p>	46

9 Additional Cylinder Accessories

	Page
 <p>Series 43 Hydrochecks</p>	48
 <p>Series 61 and 63 Valve Mounting Bracket</p>	49
 <p>Series RL Rod Lock</p>	50
 <p>Series SA Shock Absorbers</p>	51

Series 16, 23, 24 and 25 Mini-Cylinders

Single-acting and double-acting - CETOP RP52-P DIN/ISO 6432

Series 16: \varnothing 8, 10, 12 mm

Series 23: \varnothing 16, 20, 25 mm - magnetic, auto-cushioned

Series 24: \varnothing 16, 20, 25 mm - magnetic

Series 25: \varnothing 16, 20, 25 mm - magnetic cushioned

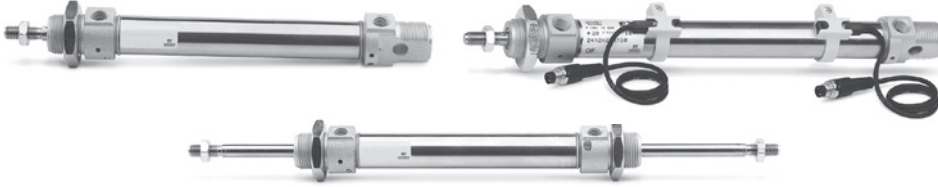

Technical Data

Operating Pressure
1 bar to 10 bar (double-acting)
2 bar to 10 bar (single-acting)

Operating Temperature
0°C to +80°C
(with dry air -20°C to +80°C)

Full Data Sheet and Dimensions at
<https://store.camozzi.co.uk>

Double-acting and Single-acting (through rod and non-standard strokes available on request)

ACCESSORIES

- ✓ Ex Stock
- 🔧 UK Assembly
- 📞 Please Call Sales Office

REED SWITCH	SWITCH MOUNTING BRACKET	BANJO FLOW CONTROL	BANJO RING FITTING	STRAIGHT CONNECTION	ELBOW FITTING
-------------	-------------------------	--------------------	--------------------	---------------------	---------------



Part Number	Availability	Bore	Port Size
-------------	--------------	------	-----------

Single-Acting. Non-Magnetic

16N1A08A*	🔧	8	M5
16N1A10A*	🔧	10	M5
16N1A12A*	🔧	12	M5

Single-Acting. Magnetic

24N1A16A*	🔧	16	M5
24N1A20A*	🔧	20	1/8
24N1A25A*	🔧	25	1/8

Double-Acting. Non-Magnetic

16N2A08A*	🔧	8	M5
16N2A10A*	🔧	10	M5
16N2A12A*	🔧	12	M5

Double-Acting. Magnetic Auto-Cushioned

23N2A16A*	📞	16	M5
23N2A20A*	📞	20	1/8
23N2A25A*	📞	25	1/8

Double-Acting. Magnetic

24N2A16A*	🔧	16	M5
24N2A20A*	🔧	20	1/8
24N2A25A*	🔧	25	1/8

Double-Acting. Magnetic Cushioned

25N2A16A*	🔧	16	M5
25N2A20A*	🔧	20	1/8
25N2A25A*	🔧	25	1/8

-	-	SCU 602-M5	6610 4-M6	6512 4-M5	6522 4-M5
-	-	SCU 602-M5	6610 4-M6	6512 4-M5	6522 4-M5
-	-	SCU 602-M5	6610 4-M6	6512 4-M5	6522 4-M5
SKR2C01200	SF16	SCU 602-M5	6610 4-M6	6512 4-M5	6522 4-M5
SKR2C01200	SF20	SCU 604-1/8	6610 6-1/8	6512 6-1/8	6522 6-1/8
SKR2C01200	SF25	SCU 604-1/8	6610 6-1/8	6512 6-1/8	6522 6-1/8
-	-	SCU 602-M5	6610 4-M6	6512 4-M5	6522 4-M5
-	-	SCU 602-M5	6610 4-M6	6512 4-M5	6522 4-M5
-	-	SCU 602-M5	6610 4-M6	6512 4-M5	6522 4-M5
SKR2C01200	SF16	SCU 602-M5	6610 4-M6	6512 4-M5	6522 4-M5
SKR2C01200	SF20	SCU 604-1/8	6610 6-1/8	6512 6-1/8	6522 6-1/8
SKR2C01200	SF25	SCU 604-1/8	6610 6-1/8	6512 6-1/8	6522 6-1/8
SKR2C01200	SF16	SCU 602-M5	6610 4-M6	6512 4-M5	6522 4-M5
SKR2C01200	SF20	SCU 604-1/8	6610 6-1/8	6512 6-1/8	6522 6-1/8
SKR2C01200	SF25	SCU 604-1/8	6610 6-1/8	6512 6-1/8	6522 6-1/8
SKR2C01200	SF16	SCU 602-M5	6610 4-M6	6512 4-M5	6522 4-M5
SKR2C01200	SF20	SCU 604-1/8	6610 6-1/8	6512 6-1/8	6522 6-1/8
SKR2C01200	SF25	SCU 604-1/8	6610 6-1/8	6512 6-1/8	6522 6-1/8

*Insert stroke length to complete part number

STANDARD STROKES FOR MINICYLINDERS SERIES 16, 24 AND 25

■ Double-acting * Single-acting

Series	16			24			23/25		
	\varnothing 8	\varnothing 10	\varnothing 12	\varnothing 16	\varnothing 20	\varnothing 25	\varnothing 16	\varnothing 20	\varnothing 25
Standard Stroke									
10	■ *	■ *	■ *	■ *	■ *	■ *	■	■	■
25	■ *	■ *	■ *	■ *	■ *	■ *	■	■	■
40	■ *	■ *	■ *	■ *	■ *	■ *	■	■	■
50	■ *	■ *	■ *	■ *	■ *	■ *	■	■	■
80	■	■	■	■	■	■	■	■	■
100	■	■	■	■	■	■	■	■	■
125	■	■	■	■	■	■	■	■	■
160	■	■	■	■	■	■	■	■	■
200	■	■	■	■	■	■	■	■	■
250			■	■	■	■	■	■	■
300			■	■	■	■	■	■	■
320				■	■	■	■	■	■
400				■	■	■	■	■	■
500				■	■	■	■	■	■

CODING EXAMPLE

24	N	2	A	16	A	100	-
24	SERIES: 16 = non-magnetic 23 = magnetic, auto-cushioning 24 = magnetic 25 = magnetic adjustable cushioning			16	BORE: 8, 10, 12, 16, 20, 25mm		
N	VERSION: N = standard			A	TYPE OF BRACKET: A = standard (screw with ring + lock nut for rod) RL = cylinder with rod lock Ø20 - Ø25		
2	OPERATION: 1 = single-acting (front spring) 2 = double-acting 3 = double-acting (through rod) 7 = single-acting (through rod)			100	STROKE: (see table)		
A	MATERIALS: A = rolled stainless steel AISI 303 rod, stainless steel AISI 304 tube, anodized AL end-blocks			-	SPECIAL: to be specified V = Rod Seal Viton W = all seals in FKM, +130°C (for series 25 only) (___) = extended rod ___mm		

NOTE: All cylinders are supplied complete with nose nut and nut for rod. The accessories are supplied separately.

PNEUMATIC ACTUATION

Series 16, 23, 24, and 25 Accessories

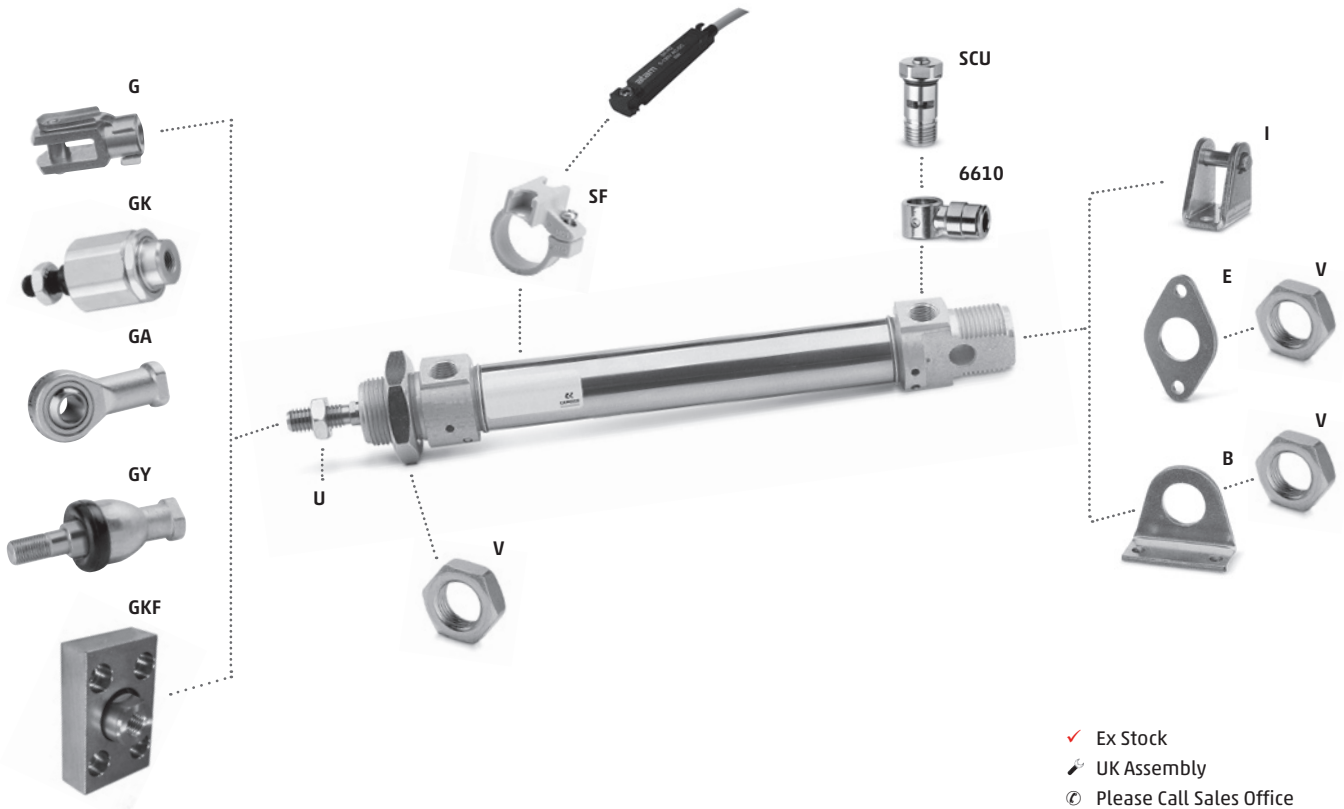

- ✓ Ex Stock
- 🔧 UK Assembly
- 📞 Please Call Sales Office

Foot Mounts (pair)	B	Front/Rear Flange Mount	E	Rear Trunnion Bracket	I	Rod Fork End	G	Swivel Ball Joint	GA
∅		∅		∅		∅		∅	
B-8-10	8-10 ✓	E-8-10	8-10 ✓	I-8-10	8-10 ✓	G-8-10	8-10 ✓	GA-8-10	8-10 ✓
B-12-16	12-16 ✓	E-12-16	12-16 ✓	I-12-16	12-16 ✓	G-12-16	12-16 ✓	GA-12-16	12-16 ✓
B-20-25	20-25 ✓	E-20-25	20-25 ✓	I-20-25	20-25 ✓	G-20	20 ✓	GA-20	20 ✓
						G-25-32	25 ✓	GA-32	25 ✓

Piston Rod Socket Joint	GY	Piston Rod Lock Nut	U	Nose Nut	V	Self Aligning Rod	GK	Coupling Piece	GKF
∅		∅		∅		∅		∅	
GY-12-16	12-16 ✓	U-8-10	8-10 ✓	V-8-10	8-10 ✓	GK-12-16	12-16 ✓	GKF-20	20 ✓
GY-20	20 ✓	U-12-16	12-16 ✓	V-12-16	12-16 ✓	GK-20	20 ✓	GKF-25-32	25 ✓
GY-32	25 ✓	U-20	20 ✓	V-20-25	20-25 ✓	GK-25-32	25 ✓		
		U-25-32	25 ✓						

Series 40 Cylinders

ISO 15552 - DIN/ISO 6431 - VDMA 24562
Double-acting, cushioned, magnetic
Ø 160, 200, 250, 320 mm

* **SAME DAY**
CYLINDER SERVICE

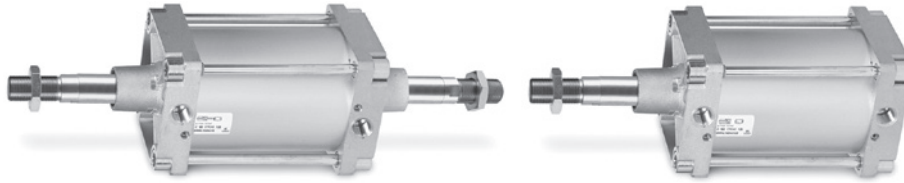

Technical Data
Operating Pressure
1 bar to 10 bar
Operating Temperature
0°C to +80°C
(with dry air -20°C to +80°C)
Full Data Sheets and Dimensions at
<https://store.camozzi.co.uk>
* Ø160 & Ø200

Double-acting (through rod and non-standard strokes available on request)

PNEUMATIC ACTUATION

ACCESSORIES

- ✓ Ex Stock
- 🔧 UK Assembly
- 📞 Please Call Sales Office

	REED SWITCH	SWITCH MOUNTING BRACKET	STRAIGHT CONNECTION	ELBOW FITTING
Double-Acting (front and rear cushions)				
40M2L160A*	CST-220	S-CST-28	S6510 16-3/4	7522 16-3/4
40M2L200A*	CST-220	S-CST-28	S6510 16-3/4	7522 16-3/4
40M2L250A*	CSN 2032-0	Direct Mounted	-	-
40M2L320A*	CSN 2032-0	Direct Mounted	-	-
Double-Acting (no cushion)				
40M3L160A*	CST-220	S-CST-28	S6510 16-3/4	7522 16-3/4
40M3L200A*	CST-220	S-CST-28	S6510 16-3/4	7522 16-3/4
40M3L250A*	CSN 2032-0	Direct Mounted	-	-
40M3L320A*	CSN 2032-0	Direct Mounted	-	-
Double-Acting (rear cushions)				
40M4L160A*	CST-220	S-CST-28	S6510 16-3/4	7522 16-3/4
40M4L200A*	CST-220	S-CST-28	S6510 16-3/4	7522 16-3/4
40M4L250A*	CSN 2032-0	Direct Mounted	-	-
40M4L320A*	CSN 2032-0	Direct Mounted	-	-
Double-Acting (front cushion)				
40M5L160A*	CST-220	S-CST-28	S6510 16-3/4	7522 16-3/4
40M5L200A*	CST-220	S-CST-28	S6510 16-3/4	7522 16-3/4
40M5L250A*	CSN 2032-0	Direct Mounted	-	-
40M5L320A*	CSN 2032-0	Direct Mounted	-	-
Double-Acting (through-rod)				
40M6L160A*	CST-220	S-CST-28	S6510 16-3/4	7522 16-3/4
40M6L200A*	CST-220	S-CST-28	S6510 16-3/4	7522 16-3/4
40M6L250A*	CSN 2032-0	Direct Mounted	-	-
40M6L320A*	CSN 2032-0	Direct Mounted	-	-

*Insert stroke length to complete part number

STANDARD STROKES FOR CYLINDERS SERIES 40

■ Double-acting

	Ø160	Ø200	Ø250	Ø320		Ø160	Ø200	Ø250	Ø320
Standard Stroke					Standard Stroke				
50	■	■	■	■	500	■	■	■	■
80	■	■	■	■	600	■	■	■	■
100	■	■	■	■	700	■	■	■	■
150	■	■	■	■	800	■	■	■	■
200	■	■	■	■	900	■	■	■	■
300	■	■	■	■	1000	■	■	■	■
400	■	■	■	■					

CODING EXAMPLE

40	M	2	L	160	A	0200	-
40	SERIES: 40			160	BORE: 160, 200, 250, 320mm		
M	VERSION: M = standard, magnetic			A	TYPE OF BRACKET: A = standard F = cylinder with centre trunnion		
2	OPERATION: 2 = double-acting (front and rear cushions) 3 = double-acting (no cushion) 4 = double-acting (rear cushions) 5 = double-acting (front cushion) 6 = double-acting (through-rod with front and rear cushions)			0200	STROKE: (see table)		
L	MATERIALS: L = rolled stainless steel rod - anodised aluminium round tube - NBR seals - nuts and tie-rods zinc-plated steel			-	= standard V = FKM rod seals W = all FKM seals +130°C C = PU coated cylinder. Colour: Grey* (___) = extended piston rod ___mm *Version C: available on request.		

NOTE: Rod nuts and accessories are supplied separately

PNEUMATIC ACTUATION

Series 40 Accessories

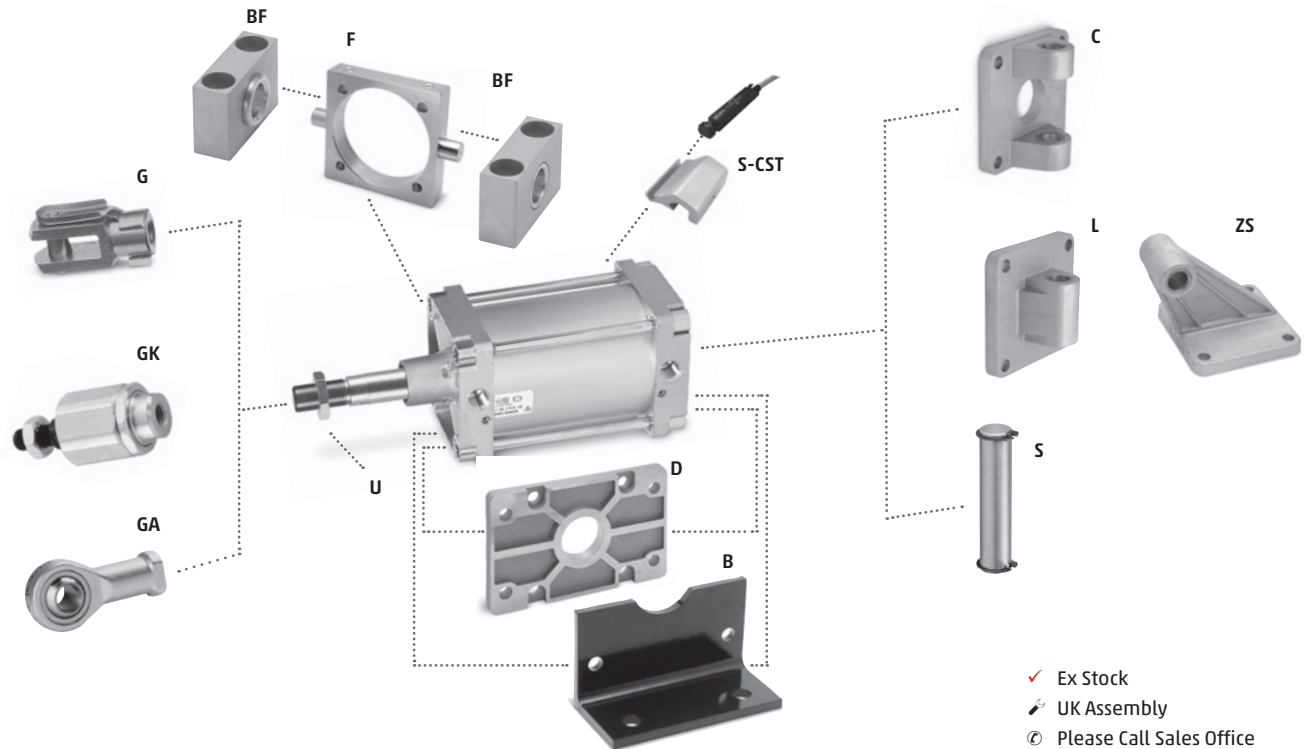

- ✓ Ex Stock
- ✎ UK Assembly
- ⊗ Please Call Sales Office

Foot Mount (pair)	B	Front and Rear Flange	D	Front and Rear Female Trunnion	C	Rear Trunnion, Male	L	Centre Trunnion	F
∅		∅		∅		∅		∅	
B-41-160	160 ✓	D-E-41-160	160 ✓	C-H-41-160	160 ✓	L-41-160	160 ✓	F-160	160 ✓
B-41-200	200 ✓	D-E-41-200	200 ✓	C-H-41-200	200 ✓	L-41-200	200 ✓	F-200	200 ✓
B-41-250	250 ⊗	D-E-41-250	250 ⊗	C-H-41-250	250 ⊗	L-41-250	250 ⊗	F-250	250 ⊗
B-41-320	320 ⊗	D-E-41-320	320 ⊗	C-H-41-320	320 ⊗	L-41-320	320 ⊗	F-320	320 ⊗
90° Swivel Trunnion	ZS	Swivel Combination	C	Counter Bracket (Pair)	BF	Rod Fork End	G	Swivel Ball Joint	GA
∅		∅		(for Centre Trunnion) ∅		∅		∅	
ZS-160	160 ✓	C+L+S 160	160 ✓	BF-160-200	160-200 ✓	G-160-200	160-200 ✓	GA-160-200	160-200 ✓
ZS-200	200 ✓	C+L+S 200	200 ✓			GA-250	250 ⊗	GA-250	250 ⊗
		C+L+S 250	250 ⊗			GA-320	320 ⊗	GA-320	320 ⊗
		C+L+S 320	320 ⊗						
Clevis Pin	S	Piston Rod Lock Nut	U	Self Aligning Rod	GK				
∅		∅		∅					
S-160-200	160-200 ✓	U-160-200	160-200 ✓	GK-160-200	160-200 ✓				
S-250	250 ⊗	U-250	250 ⊗						
S-320	320 ⊗	U-320	320 ⊗						

Series 41 Cylinders - Aluminium Profile

DIN/ISO 6431 - VDMA 24562

Double-acting cushioned, magnetic

Ø 160, 200 mm

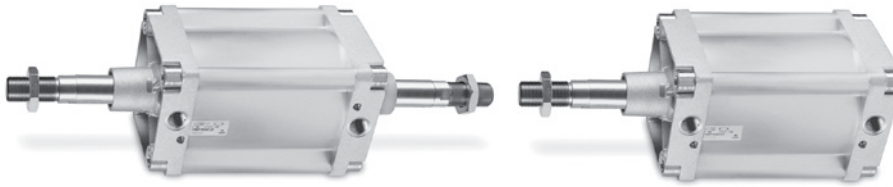

Technical Data

Operating Pressure
1 bar to 10 bar

Operating Temperature
0°C to +80°C
(with dry air -20°C to +80°C)

Full Data Sheet and Dimensions at
<https://store.camozzi.co.uk>



PNEUMATIC ACTUATION

Non-standard strokes available on request.

ACCESSORIES

- ✓ Ex Stock
- ✎ UK Assembly
- ⓞ Please Call Sales Office

Part Number	Availability	Bore	Port Size
Double-Acting (front and rear cushions)			
41M2L160A*	✎	160	3/4
41M2L200A*	✎	200	3/4
Double-Acting (no cushion)			
41M3L160A*	✎	160	3/4
41M3L200A*	✎	200	3/4
Double-Acting (rear cushions)			
41M4L160A*	✎	160	3/4
41M4L200A*	✎	200	3/4
Double-Acting (front cushion)			
41M5L160A*	✎	160	3/4
41M5L200A*	✎	200	3/4
Double-Acting (through-rod)			
41M6L160A*	✎	160	3/4
41M6L200A*	✎	200	3/4

	STRAIGHT CONNECTION	ELBOW FITTING
		
	S6510 16-3/4	7522 16-3/4
	S6510 16-3/4	7522 16-3/4
	S6510 16-3/4	7522 16-3/4
	S6510 16-3/4	7522 16-3/4
	S6510 16-3/4	7522 16-3/4
	S6510 16-3/4	7522 16-3/4
	S6510 16-3/4	7522 16-3/4
	S6510 16-3/4	7522 16-3/4
	S6510 16-3/4	7522 16-3/4
	S6510 16-3/4	7522 16-3/4

*Insert stroke length to complete part number

STANDARD STROKES FOR CYLINDERS SERIES 41

■ Double-acting

	Ø160	Ø200		Ø160	Ø200
Standard Stroke			Standard Stroke		
50	■	■	500	■	■
80	■	■	600	■	■
100	■	■	700	■	■
150	■	■	800	■	■
200	■	■	900	■	■
300	■	■	1000	■	■
400	■	■			

CODING EXAMPLE

41	M	2	P	160	A	0200	-
41	SERIES: 41			160	BORE: 160, 200mm		
M	VERSION: M = standard, magnetic			A	TYPE OF BRACKET: A = tie-rods F = cylinder with centre trunnion		
2	OPERATION: 2 = double-acting (front and rear cushions) 3 = double-acting (no cushion) 4 = double-acting (rear cushions) 5 = double-acting (front cushion) 6 = double-acting (through-rod with front and rear cushions)			0200	STROKE: (see table)		
P	MATERIALS: P = rolled stainless steel rod NBR seals, nuts and tie-rods zinc-plated steel			-	= standard V = FKM rod seals W = all FKM seals +130°C C = PU coated cylinder. Colour: Grey* (___) = extended piston rod ___mm *Version C: available on request.		

NOTE: Rod nuts and accessories are supplied separately

PNEUMATIC ACTUATION

Series 41 Accessories

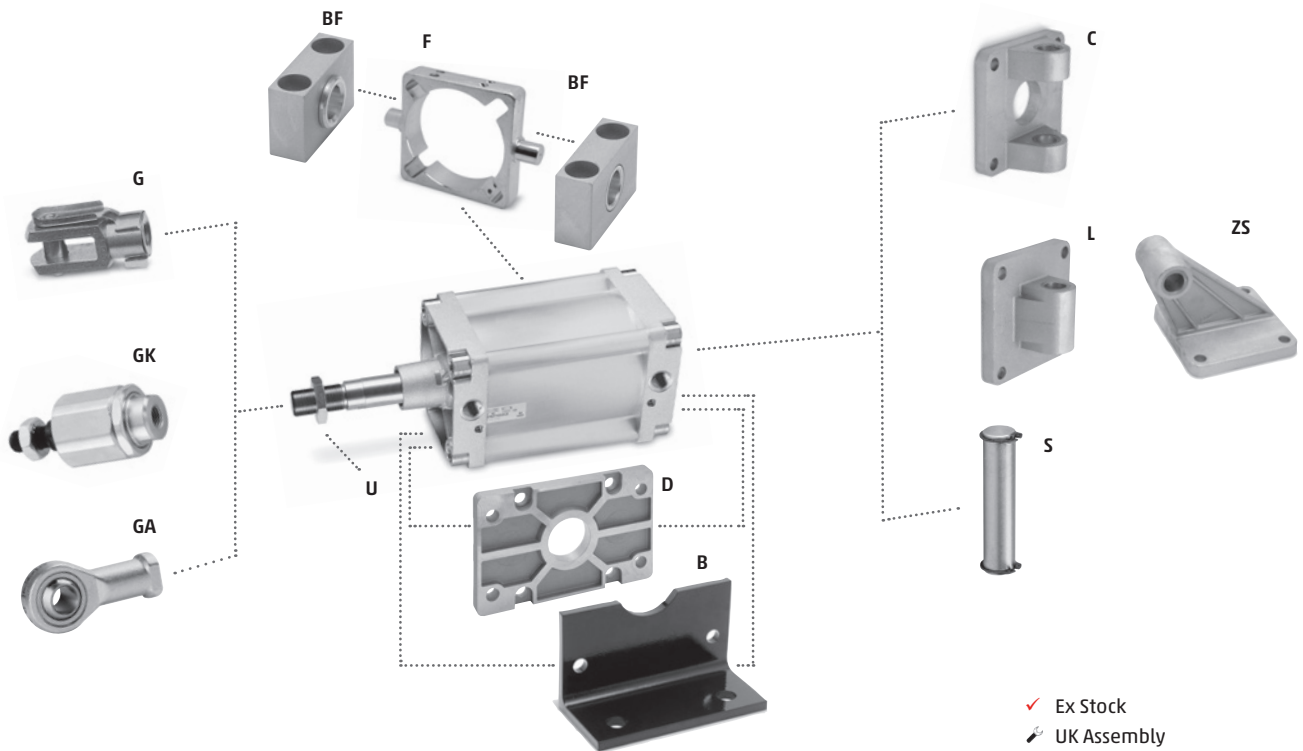

- ✓ Ex Stock
- 🇬🇧 UK Assembly
- 📞 Please Call Sales Office

Foot Mount (pair)	B	Front and Rear Flange	D	Front and Rear Female Trunnion	C	Rear Trunnion, Male	L	Centre Trunnion	F
∅		∅		∅		∅		∅	
B-41-160	160 ✓	D-E-41-160	160 ✓	C-H-41-160	160 ✓	L-41-160	160 ✓	F-160	160 ✓
B-41-200	200 ✓	D-E-41-200	200 ✓	C-H-41-200	200 ✓	L-41-200	200 ✓	F-200	200 ✓
90° Swivel Trunnion	ZS	Swivel Combination	C	Counter Bracket (Pair)	BF	Rod Fork End	G	Swivel Ball Joint	GA
∅		∅		(for Centre Trunnion) ∅		∅		∅	
ZS-160	160 ✓	C+L+S 160	160 ✓	BF-160-200	160-200 ✓	G-160-200	160-200 ✓	GA-160-200	160-200 ✓
ZS-200	200 ✓	C+L+S 200	200 ✓						
Clevis Pin	S	Piston Rod Lock Nut	U	Self Aligning Rod	GK				
∅		∅		∅					
S-160-200	160-200 ✓	U-160-200	160-200 ✓	GK-160-200	160-200 ✓				

Series 61 Cylinders - Aluminium Profile

ISO 15552 - DIN/ISO 6431 - VDMA 24562

Single and double-acting, magnetic, cushioned. Standard, low friction, low temperatures and tandem versions

Ø 32, 40, 50, 63, 80, 100, 125 mm

Example of assembly with a valve on page 49



Technical Data

Operating Pressure
Min 1 to max 10 bar (standard and low temperatures)
0.1 to 10 bar (low friction)

Operating Temperature
Standard and low friction: 0°C to +80°C.
(with dry air -20°C)
Low temperature: (-40°C version):
-40°C to 60°C (with dry air -40°C)
Low temperature: (-50°C version):
-50°C to 60°C (with dry air -50°C)

Full Data Sheet and Dimensions at
<https://store.camozzi.co.uk>

Double-acting and Single-acting (through rod and non-standard strokes available on request)

ACCESSORIES

- ✓ Ex Stock
- 🔧 UK Assembly
- 📞 Please Call Sales Office



Part Number	Availability	Bore	Port Size	REED SWITCH	SWITCH MOUNTING BRACKET	BANJO FLOW CONTROL	BANJO RING FITTING	STRAIGHT CONNECTION	ELBOW FITTING
Single-Acting (Magnetic)									
61M1P032A*	🔧	32	1/8	SKR2C01200	Direct Mount	SCU 604-1/8	6610 4-1/8	S6510 4-1/8	S6520 4-1/8
61M1P040A*	🔧	40	1/4	SKR2C01200	Direct Mount	SCU 606-1/4	6610 6-1/4	S6510 6-1/4	S6520 6-1/4
61M1P050A*	🔧	50	1/4	SKR2C01200	Direct Mount	SCU 606-1/4	6610 6-1/4	S6510 6-1/4	S6520 6-1/4
61M1P063A*	🔧	63	3/8	SKR2C01200	Direct Mount	SCU 608-3/8	6610 8-3/8	S6510 8-3/8	S6520 8-3/8
61M1P080A*	🔧	80	3/8	SKR2C01200	Direct Mount	SCU 608-3/8	6610 8-3/8	S6510 8-3/8	S6520 8-3/8
61M1P100A*	🔧	100	1/2	SKR2C01200	Direct Mount	SCU 610-1/2	S6510 10-1/2	S6510 10-1/2	S6520 10-1/2
Double-Acting (Magnetic)									
61M2P032A*	🔧	32	1/8	SKR2C01200	Direct Mount	SCU 604-1/8	6610 4-1/8	S6510 4-1/8	S6520 4-1/8
61M2P040A*	🔧	40	1/4	SKR2C01200	Direct Mount	SCU 606-1/4	6610 6-1/4	S6510 6-1/4	S6520 6-1/4
61M2P050A*	🔧	50	1/4	SKR2C01200	Direct Mount	SCU 606-1/4	6610 6-1/4	S6510 6-1/4	S6520 6-1/4
61M2P063A*	🔧	63	3/8	SKR2C01200	Direct Mount	SCU 608-3/8	6610 8-3/8	S6510 8-3/8	S6520 8-3/8
61M2P080A*	🔧	80	3/8	SKR2C01200	Direct Mount	SCU 608-3/8	6610 8-3/8	S6510 8-3/8	S6520 8-3/8
61M2P100A*	🔧	100	1/2	SKR2C01200	Direct Mount	SCU 610-1/2	S6510 10-1/2	S6510 10-1/2	S6520 10-1/2
61M2P125A*	🔧	125	1/2	CST-220	Direct Mount	SCU 610-1/2	S6510 10-1/2	S6510 10-1/2	S6520 10-1/2

*Insert stroke length to complete part number

UK Cylinder Service



Reduce Lead Times for Pneumatic Cylinders

- Built the same or next day
- Includes many cylinder types

STANDARD STROKES FOR CYLINDERS SERIES 61

■ Double-acting * Single-acting

	ø32	ø40	ø50	ø63	ø80	ø100	ø125
Standard Stroke							
25	■*	■*	■*	■*	■*		
50	■*	■*	■*	■*	■*	■*	■
75	■*	■*	■*	■*	■*	■*	■
80	■	■	■	■	■	■	■
100	■	■	■	■	■	■	■
125	■	■	■	■	■	■	■
150	■	■	■	■	■	■	■
160	■	■	■	■	■	■	■
200	■	■	■	■	■	■	■
250	■	■	■	■	■	■	■
300	■	■	■	■	■	■	■
320	■	■	■	■	■	■	■
400	■	■	■	■	■	■	■
500	■	■	■	■	■	■	■
600	■	■	■	■	■	■	■
700	■	■	■	■	■	■	■
800	■	■	■	■	■	■	■
900	■	■	■	■	■	■	■
1000	■	■	■	■	■	■	■

For cylinders over 1000mm stroke and other versions, please contact our sales office or your local Camozzi distributor.

PNEUMATIC ACTUATION

CODING EXAMPLE

61	M	2	P	050	A	0200	-
61	SERIES: 61 = from ø32 - 125 DIN/ISO 15552			050	BORE: 32, 40, 50, 63, 80, 100, 125mm		
M	VERSION: M = magnetic N = non magnetic L = Low friction, magnetic			A	CONSTRUCTION: A = standard with rod nut RL = cylinder with rod lock		
2	OPERATION: 1 = single-acting (front spring) 2 = double-acting (front and rear cushions) 3 = double-acting (no cushion) 4 = double-acting (rear cushions) 5 = double-acting (front cushion) 6 = double-acting (through-rod with front and rear cushions) 7 = single-acting (through-rod)			0200	STROKE: (see table)		
P	MATERIALS: P = rolled stainless steel rod, AISI 420B anodised profile aluminium tube NBR seals - rod seals polyurethane, nuts and tie-rods zinc-plated steel (See full technical catalogue for all options)			= standard V = FKM rod seal N = tandem R = NBR rod seal W = all FKM seals +130°C C = PU coated cylinder. Colour: Grey* L = low friction version without rod seal (rear supply only)** (_ _) = extended piston rod _ _ _ mm G = with brass rod scraper (chrome plated stainless steel AISI 420B rod, NBR rod seal) [ø 125 excepted] **Version C: available on request. **The possibility to order the cylinder without piston rod seal, further reduces the friction force.			

61M2P = standard version in stock (32 - 100)

Note: All cylinder are supplied with rod nuts. The accessories are supplied separately

Series 61 Accessories

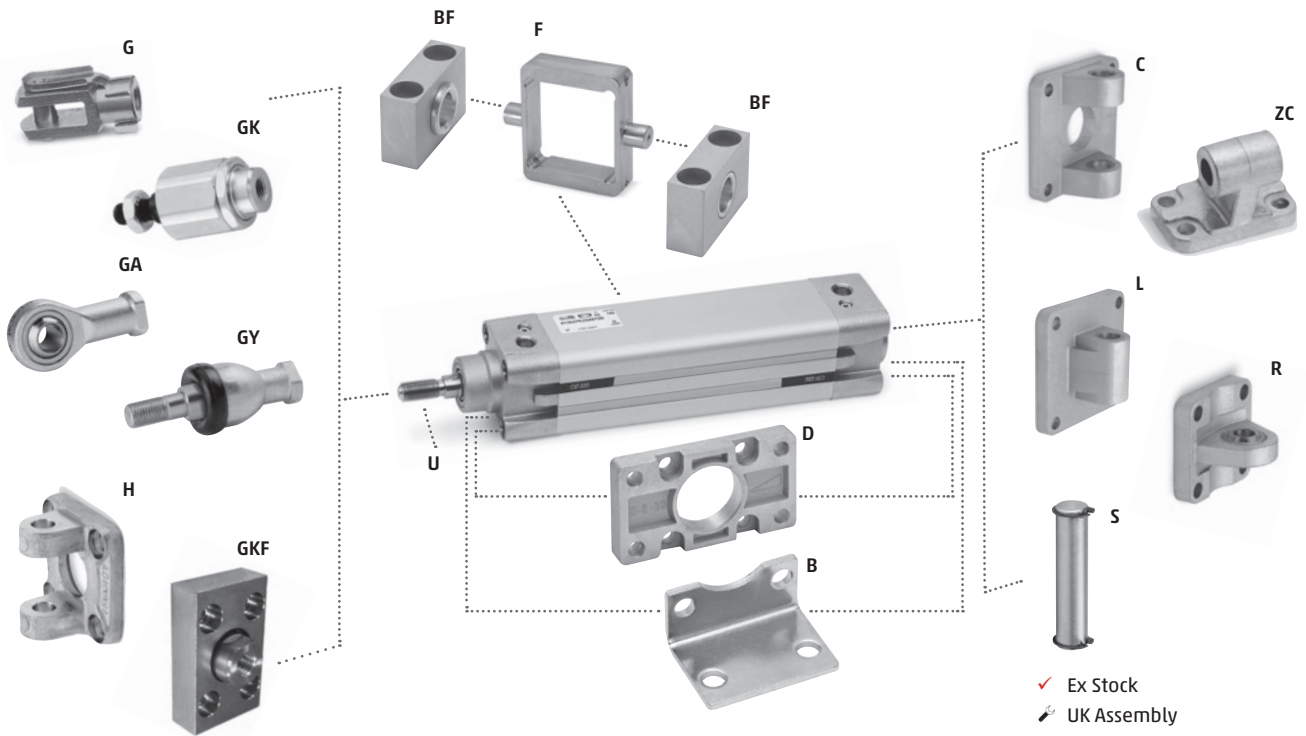

Foot Mount (pair)	B	Front and Rear Flange	D	Rear Trunnion, Female	C	Rear Trunnion, Male	L
	∅		∅		∅		∅
B-41-32	32 ✓	D-E-41-32	32 ✓	C-41-32	32 ✓	L-41-32	32 ✓
B-41-40	40 ✓	D-E-41-40	40 ✓	C-41-40	40 ✓	L-41-40	40 ✓
B-41-50	50 ✓	D-E-41-50	50 ✓	C-41-50	50 ✓	L-41-50	50 ✓
B-41-63	63 ✓	D-E-41-63	63 ✓	C-H-41-63	63 ✓	L-41-63	63 ✓
B-41-80	80 ✓	D-E-41-80	80 ✓	C-H-41-80	80 ✓	L-41-80	80 ✓
B-41-100	100 ✓	D-E-41-100	100 ✓	C-H-41-100	100 ✓	L-41-100	100 ✓
B-41-125	125 ✓	D-E-41-125	125 ✓	C-H-41-125	125 ✓	L-41-125	125 ✓

Front Trunnion, Female	H	Centre Trunnion	F	90° Swivel Trunnion (CETOP RP 107P)	ZC	Rear Trunnion Ball Joint	R
	∅		∅		∅		∅
H-41-32	32 ✓	F-61-32	32 ✓	ZC 32	32 ✓	R-41-32	32 ✓
H-41-40	40 ✓	F-61-40	40 ✓	ZC 40	40 ✓	R-41-40	40 ✓
H-41-50	50 ✓	F-61-50	50 ✓	ZC 50	50 ✓	R-41-50	50 ✓
H-60-63	63 ✓	F-61-63	63 ✓	ZC 63	63 ✓	R-41-63	63 ✓
C-H-41-80	80 ✓	F-61-80	80 ✓	ZC 80	80 ✓	R-41-80	80 ✓
C-H-41-100	100 ✓	F-61-100	100 ✓	ZC 100	100 ✓	R-41-100	100 ✓
C-H-41-125	125 ✓	F-61-125	125 ✓	ZC 125	125 ✓	R-41-125	125 ✓

Counter Bracket (Pair) (for Centre Trunnion)	BF	Rod Fork End	G	Swivel Ball Joint	GA	Piston Rod Socket Joint	GY
	∅		∅		∅		∅
BF-32	32 ✓	G-25-32	32 ✓	GA-32	32 ✓	GY-32	32 ✓
BF-40-50	40-50 ✓	G-40	40 ✓	GA-40	40 ✓	GY-40	40 ✓
BF-63-80	63-80 ✓	G-50-63	50-63 ✓	GA-50-63	50-63 ✓	GY-50-63	50-63 ✓
BF-100-125	100-125 ✓	G-80-100	80-100 ✓	GA-80-100	80-100 ✓	GY-80-100	80-100 ✓
		G-41-125	125 ✓	GA-41-125	125 ✓		

Clevis Pin	S	Piston Rod Lock Nut	U	Self Aligning Rod	GK	Coupling Piece	GKF
	∅		∅		∅		∅
S-32	32 ✓	U-25-32	32 ✓	GK-25-32	32 ✓	GKF-25-32	32 ✓
S-40	40 ✓	U-40	40 ✓	GK-40	40 ✓	GKF-40	40 ✓
S-50	50 ✓	U-50-63	50-63 ✓	GK-50-63	50-63 ✓	GKF-50-63	50-63 ✓
S-63	63 ✓	U-80-100	80-100 ✓	GK-80-100	80-100 ✓	GKF-80-100	80-100 ✓
S-80	80 ✓	U-41-125	125 ✓	GK-125	125 ✓	GKF-125	125 ✓
S-100	100 ✓						
S-125	125 ✓						

Series 63 Cylinders - ISO 15552

Single and double-acting, magnetic, cushioned.
Standard, low friction, high and low temperatures
Ø 32, 40, 50, 63, 80, 100, 125 mm.

Example of assembly with a valve on page 49



Technical Data

Operating Pressure
1 bar to 10 bar (standard, high and low temperatures)
0.1 bar to 10 bar (low friction)

Operating Temperature
Standard and low friction: 0°C to +80°C. (with dry air -20°C)
High temperatures (version W): 0°C to +150°C. (with dry air -20°C)
Low temperatures (version Z): -40°C to 60°C (with dry air -40°C)
Low temperatures (version Y): -50°C to 60°C (with dry air -50°C)

Full Data Sheet and Dimensions at
<https://store.camozzi.co.uk>

PNEUMATIC ACTUATION

ACCESSORIES

- ✓ Ex Stock
- ✎ UK Assembly
- ⊗ Please Call Sales Office

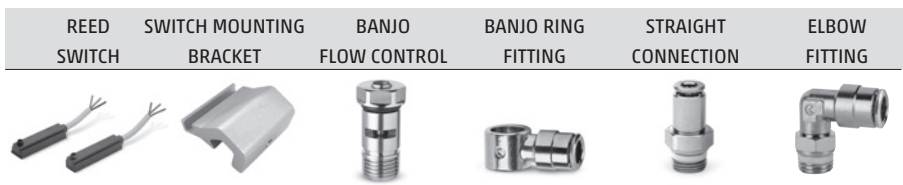

Part Number Availability Bore Port Size

Round Tube Construction

Single-Acting (Magnetic), Cushioning on both sides

63MT1C032A*	✎	32	1/8
63MT1C040A*	✎	40	1/4
63MT1C050A*	✎	50	1/4
63MT1C063A*	✎	63	3/8
63MT1C080A*	✎	80	3/8
63MT1C100A*	✎	100	1/2
63MT1C125A*	✎	125	1/2

CST-220	SCD32	SCU 604-1/8	6610 4-1/8	S6510 4-1/8	S6520 4-1/8
CST-220	SCD32	SCU 606-1/4	6610 6-1/4	S6510 6-1/4	S6520 6-1/4
CST-220	SCD32	SCU 606-1/4	6610 6-1/4	S6510 6-1/4	S6520 6-1/4
CST-220	SCD32	SCU 608-3/8	6610 8-3/8	S6510 8-3/8	S6520 8-3/8
CST-220	SCD80	SCU 608-3/8	6610 8-3/8	S6510 8-3/8	S6520 8-3/8
CST-220	SCD80	SCU 610-1/2	S6510 10-1/2	S6510 10-1/2	S6520 10-1/2
CST-220	S-CST-27	SCU 610-1/2	S6510 10-1/2	S6510 10-1/2	S6520 10-1/2

Double-Acting (Magnetic), Cushioning on both sides

63MT2C032A*	✎	32	1/8
63MT2C040A*	✎	40	1/4
63MT2C050A*	✎	50	1/4
63MT2C063A*	✎	63	3/8
63MT2C080A*	✎	80	3/8
63MT2C100A*	✎	100	1/2
63MT2C125A*	✎	125	1/2

CST-220	SCD32	SCU 604-1/8	6610 4-1/8	S6510 4-1/8	S6520 4-1/8
CST-220	SCD32	SCU 606-1/4	6610 6-1/4	S6510 6-1/4	S6520 6-1/4
CST-220	SCD32	SCU 606-1/4	6610 6-1/4	S6510 6-1/4	S6520 6-1/4
CST-220	SCD32	SCU 608-3/8	6610 8-3/8	S6510 8-3/8	S6520 8-3/8
CST-220	SCD80	SCU 608-3/8	6610 8-3/8	S6510 8-3/8	S6520 8-3/8
CST-220	SCD80	SCU 610-1/2	S6510 10-1/2	S6510 10-1/2	S6520 10-1/2
CST-220	S-CST-27	SCU 610-1/2	S6510 10-1/2	S6510 10-1/2	S6520 10-1/2

Profile Construction

Single-Acting (Magnetic), Cushioning on both sides

63MP1C032A*	✎	32	1/8
63MP1C040A*	✎	40	1/4
63MP1C050A*	✎	50	1/4
63MP1C063A*	✎	63	3/8
63MP1C080A*	✎	80	3/8
63MP1C100A*	✎	100	1/2
63MP1C125A*	✎	125	1/2

CSH-223-2	Direct Mount	SCU 604-1/8	6610 4-1/8	S6510 4-1/8	S6520 4-1/8
CSH-223-2	Direct Mount	SCU 606-1/4	6610 6-1/4	S6510 6-1/4	S6520 6-1/4
CSH-223-2	Direct Mount	SCU 606-1/4	6610 6-1/4	S6510 6-1/4	S6520 6-1/4
CSH-223-2	Direct Mount	SCU 608-3/8	6610 8-3/8	S6510 8-3/8	S6520 8-3/8
CSH-223-2	Direct Mount	SCU 608-3/8	6610 8-3/8	S6510 8-3/8	S6520 8-3/8
CSH-223-2	Direct Mount	SCU 610-1/2	S6510 10-1/2	S6510 10-1/2	S6520 10-1/2
CSH-223-2	Direct Mount	SCU 610-1/2	S6510 10-1/2	S6510 10-1/2	S6520 10-1/2

Double-Acting (Magnetic), Cushioning on both sides

63MP2C032A*	✎	32	1/8
63MP2C040A*	✎	40	1/4
63MP2C050A*	✎	50	1/4
63MP2C063A*	✎	63	3/8
63MP2C080A*	✎	80	3/8
63MP2C100A*	✎	100	1/2
63MP2C125A*	✎	125	1/2

CSH-223-2	Direct Mount	SCU 604-1/8	6610 4-1/8	S6510 4-1/8	S6520 4-1/8
CSH-223-2	Direct Mount	SCU 606-1/4	6610 6-1/4	S6510 6-1/4	S6520 6-1/4
CSH-223-2	Direct Mount	SCU 606-1/4	6610 6-1/4	S6510 6-1/4	S6520 6-1/4
CSH-223-2	Direct Mount	SCU 608-3/8	6610 8-3/8	S6510 8-3/8	S6520 8-3/8
CSH-223-2	Direct Mount	SCU 608-3/8	6610 8-3/8	S6510 8-3/8	S6520 8-3/8
CSH-223-2	Direct Mount	SCU 610-1/2	S6510 10-1/2	S6510 10-1/2	S6520 10-1/2
CSH-223-2	Direct Mount	SCU 610-1/2	S6510 10-1/2	S6510 10-1/2	S6520 10-1/2

*Insert stroke length to complete part number

STANDARD STROKES FOR CYLINDERS SERIES 63

- Double-acting, (standard, low friction, high/low temperatures)
- * Single-acting front spring (standard, high/low temperature)
- ▲ Single-acting, rear spring (standard, high/low temperatures)

	ø32	ø40	ø50	ø63	ø80	ø100	ø125
Standard Stroke							
25	■*▲	■*▲	■*▲	■*▲	■*▲		
50	■*▲	■*▲	■*▲	■*▲	■*▲	■*▲	■*▲
75	■*	■*	■*	■*	■*	■*	■*
80	■	■	■	■	■	■	■
100	■	■	■	■	■	■	■
125	■	■	■	■	■	■	■
150	■	■	■	■	■	■	■
160	■	■	■	■	■	■	■
200	■	■	■	■	■	■	■
250	■	■	■	■	■	■	■
300	■	■	■	■	■	■	■
320	■	■	■	■	■	■	■
400	■	■	■	■	■	■	■
500	■	■	■	■	■	■	■

For cylinders over 1000mm stroke and other versions, please contact our sales office or your local Camozzi distributor.

CODING EXAMPLE

63 | **M** | **P** | **2** | **C** | **050** | **A** | **0200** | **W** | | | | | |

63	SERIES: 63	W	TEMPERATURE RANGE: = standard (-20°C/+80°C) W = high temperatures (150°C) Z = low temperatures (-40°C) Y = low temperatures (-50°C)
M	VERSION: M = standard, magnetic V = smooth movement (low speed), magnetic L = Low friction, magnetic		
P	CONSTRUCTION: T = round tube P = profile		RESISTANCE TO CORROSION: = standard C1 = rod nut AISI 304 stainless steel, rod AISI 304 stainless steel C2 = end cap treated screws (profile) or AISI 303 tie-rods and AISI 420B tie-rods (round tube) C3 = C2 + AISI 316 rod nut, AISI 316 rod C4 = C1 + C2 C5 = C3 + end caps with triple protection
2	OPERATION: 1 = single-acting, front spring 2 = double-acting 6 = double-acting, through-rod 7 = single-acting, through-rod 9 = single-acting, rear spring		
C	CUSHIONING: N = no cushioning (mechanical endstops) C = cushioning on both sides F = front cushioning R = rear cushioning		ROD VARIATIONS: = standard (male rod thread) F = female rod thread K = end caps with Kanigen treatment L = without rod seal (rear air inlet only) V = FKM rod seal R = NBR rod seal U = unlubricated operation H = hydrolytic environment A = use in food and other frequent washdown applications G = dry and dusty environments (with brass rod scraper and chrome-plated stainless steel AISI 420B rod) B = cylinder with NBR bellow rod protection B2 = cylinder with through rod and NBR bellow rod protection on both sides (__ __) = rod longer than __ __ mm
050	BORE: 32, 40, 50, 63, 80, 100, 125mm		
A	CONSTRUCTION: A = standard with rod nut RL = cylinder with rod lock DC = back to back cylinder with DC accessory (X1/X2) TR = back to back cylinder for round tube (X1/X2) F = cylinder with centre trunnion		
0200	STROKE: = standard N = tandem / = more positions X1/X2 (X1<X2)		
			OTHER: P = cylinder with RAL 7035 polyurethane coating
			CERTIFICATIONS: EX = ATEX

Series 63 Accessories - Round Tube

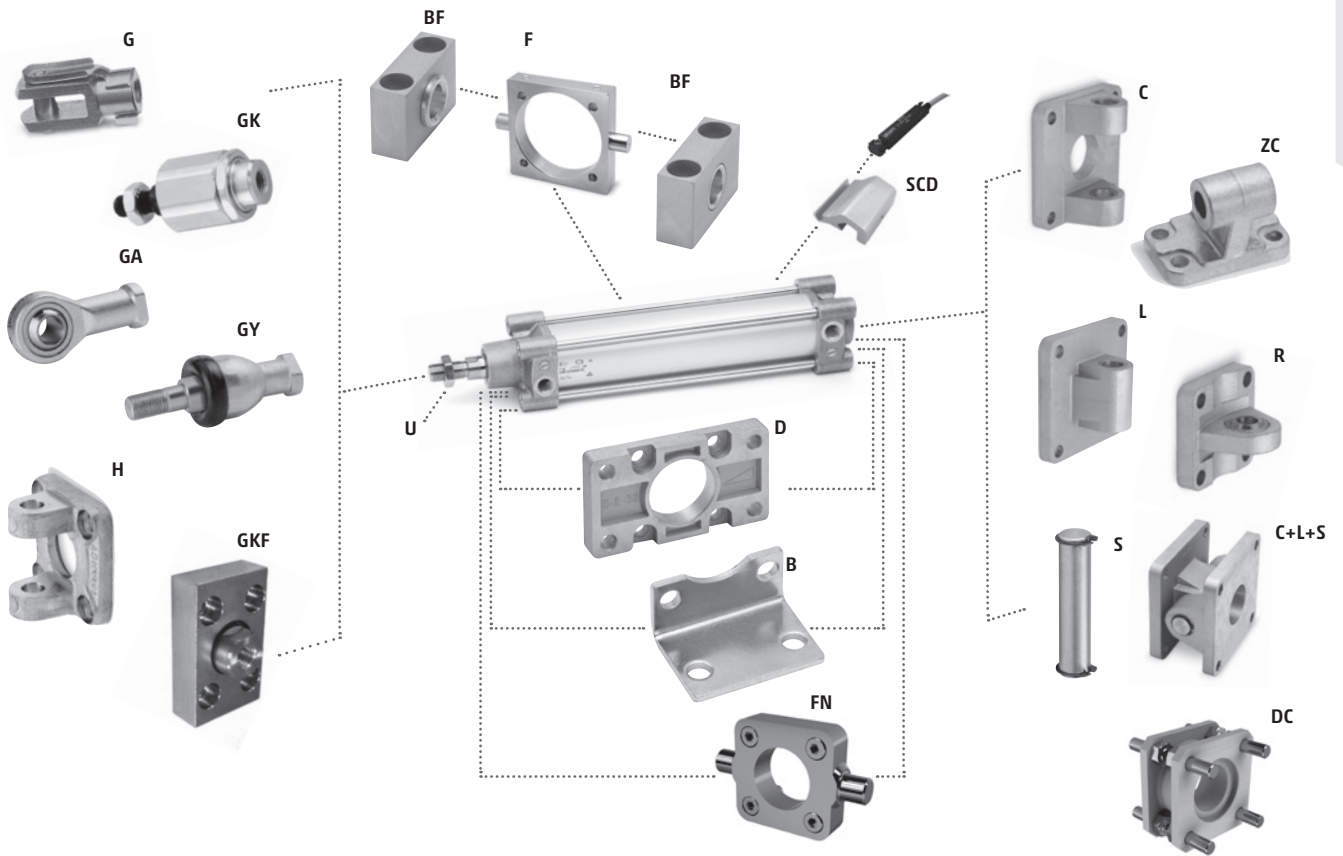

Series 63 Accessories - Profile

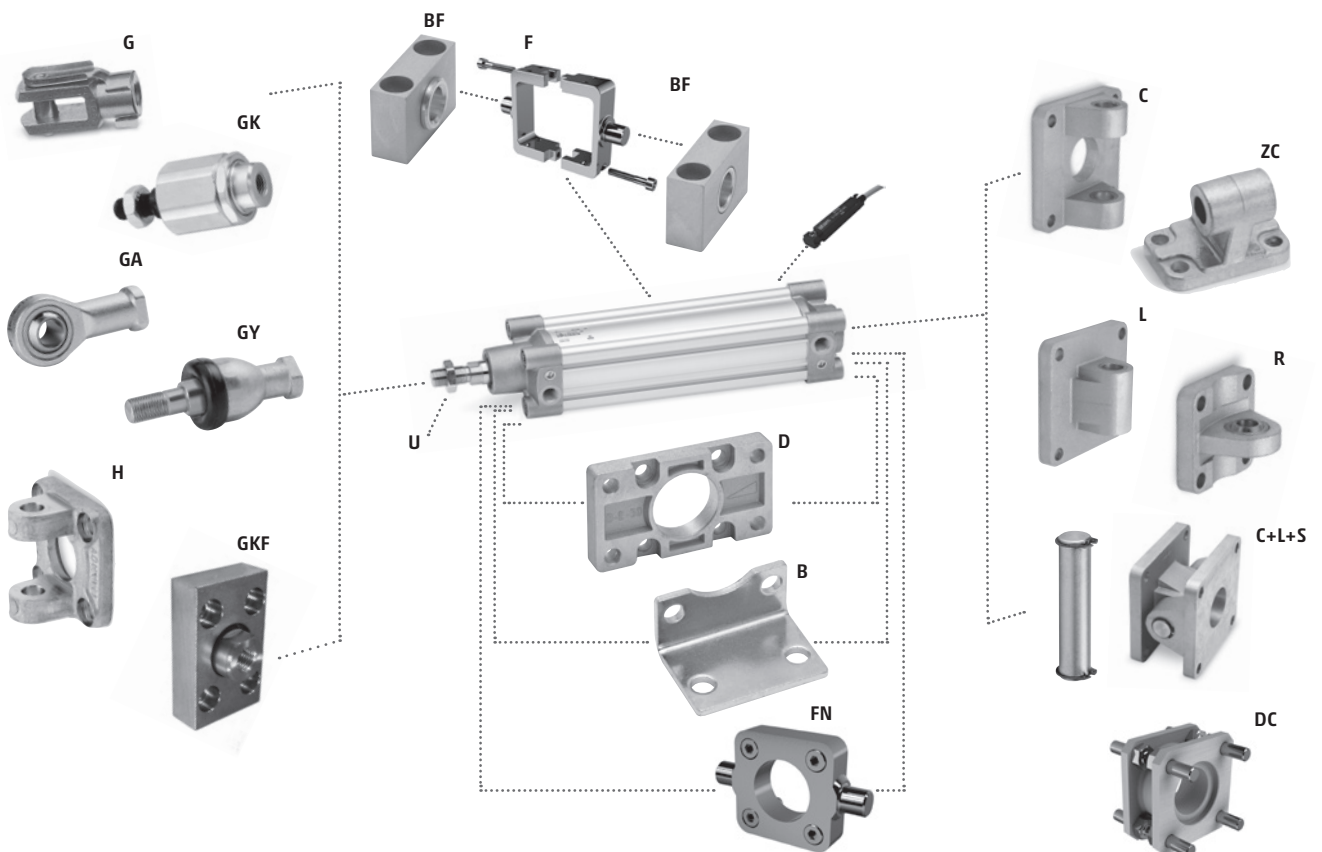

Series 63 Accessories

- ✓ Ex Stock
- 🔧 UK Assembly
- 📞 Please Call Sales Office

Foot Mount (pair) B		Front and Rear Flange D		Rear Trunnion, Female C		Rear Trunnion, Male L	
∅		∅		∅		∅	
B-41-32	32 ✓	D-E-41-32	32 ✓	C-41-32	32 ✓	L-41-32	32 ✓
B-41-40	40 ✓	D-E-41-40	40 ✓	C-41-40	40 ✓	L-41-40	40 ✓
B-41-50	50 ✓	D-E-41-50	50 ✓	C-41-50	50 ✓	L-41-50	50 ✓
B-41-63	63 ✓	D-E-41-63	63 ✓	C-H-41-63	63 ✓	L-41-63	63 ✓
B-41-80	80 ✓	D-E-41-80	80 ✓	C-H-41-80	80 ✓	L-41-80	80 ✓
B-41-100	100 ✓	D-E-41-100	100 ✓	C-H-41-100	100 ✓	L-41-100	100 ✓
B-41-125	125 ✓	D-E-41-125	125 ✓	C-H-41-125	125 ✓	L-41-125	125 ✓

Front Trunnion, Female H		90° Swivel Trunnion ZC		Rear Trunnion Ball Joint R		Counter Bracket (Pair) BF (for Centre Trunnion) ∅	
∅		∅		∅		∅	
H-41-32	32 ✓	ZC 32	32 ✓	R-41-32	32 ✓	BF-32	32 ✓
H-41-40	40 ✓	ZC 40	40 ✓	R-41-40	40 ✓	BF-40-50	40-50 ✓
H-41-50	50 ✓	ZC 50	50 ✓	R-41-50	50 ✓	BF-63-80	63-80 ✓
H-60-63	63 ✓	ZC 63	63 ✓	R-41-63	63 ✓	BF-100-125	100-125 ✓
C-H-41-80	80 ✓	ZC 80	80 ✓	R-41-80	80 ✓		
C-H-41-100	100 ✓	ZC 100	100 ✓	R-41-100	100 ✓		
C-H-41-125	125 ✓	ZC 125	125 ✓	R-41-125	125 ✓		

Opposed Cylinder Coupler DC		Front/Rear Trunnion FN		Rod Fork End G		Swivel Ball Joint GA	
∅		∅		∅		∅	
DC-63-32	32 📞	FN-32	32 📞	G-25-32	32 ✓	GA-32	32 ✓
DC-63-40	40 📞	FN-40	40 📞	G-40	40 ✓	GA-40	40 ✓
DC-63-50	50 📞	FN-50	50 📞	G-50-63	50-63 ✓	GA-50-63	50-63 ✓
DC-63-63	63 📞	FN-63	63 📞	G-80-100	80-100 ✓	GA-80-100	80-100 ✓
DC-63-80	80 📞	FN-80	80 📞	G-41-125	125 ✓	GA-41-125	125 ✓
DC-63-100	100 📞	FN-100	100 📞				
DC-63-125	125 📞	FN-125	125 📞				

Piston Rod Socket Joint GY		Clevis Pin S		Piston Rod Lock Nut U		Self Aligning Rod GK	
∅		∅		∅		∅	
GY-32	32 ✓	S-32	32 ✓	U-25-32	32 ✓	GK-25-32	25-32 ✓
GY-40	40 ✓	S-40	40 ✓	U-40	40 ✓	GK-40	40 ✓
GY-50-63	50-63 ✓	S-50	50 ✓	U-50-63	50-63 ✓	GK-50-63	50-63 ✓
GY-80-100	80-100 ✓	S-63	63 ✓	U-80-100	80-100 ✓	GK-80-100	80-100 ✓
		S-80	80 ✓	U-41-125	125 ✓	GK-125	125 ✓
		S-100	100 ✓				
		S-125	125 ✓				

Coupling Piece GKF		Swivel Combination C+L+S		Centre Trunnion (for round tube) F		Centre Trunnion (for Profile) F	
∅		∅		∅		∅	
GKF-25-32	32 ✓	C+L+S-32	32 ✓	F-32	32 ✓	F-63-32	32 ✓
GKF-40	40 ✓	C+L+S-40	40 ✓	F-40	40 ✓	F-63-40	40 ✓
GKF-50-63	50-63 ✓	C+L+S-50	50 ✓	F-50	50 ✓	F-63-50	50 ✓
GKF-80-100	80-100 ✓	C+L+S-63	63 ✓	F-63	63 ✓	F-63-63	63 ✓
GKF-125	125 ✓	C+L+S-80	80 ✓	F-80	80 ✓	F-63-80	80 ✓
		C+L+S-100	100 ✓	F-100	100 ✓	F-63-100	100 ✓
		C+L+S-125	125 ✓	F-125	125 ✓	F-63-125	125 ✓

Series 32 Compact Magnetic Cylinders

ISO 21287

Single and Double-acting, non-rotating, magnetic
 Ø 20, 25, 32, 40, 50, 63, 80, 100 mm

SAME DAY
CYLINDER SERVICE



Also available in tandem and multi-position versions

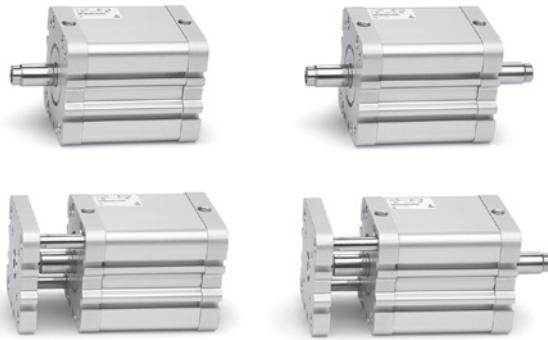

Technical Data

Operating Pressure
 1 bar to 10 bar (double-acting)
 2 bar to 10 bar (single-acting)

Operating Temperature
 0°C to +80°C.
 (with dry air -20°C)

Full Data Sheet and Dimensions at
<https://store.camozzi.co.uk>

PNEUMATIC ACTUATION

Double-acting, Single-acting and Non-rotating (through rod and non-standard strokes available on request)

STANDARD STROKES FOR CYLINDERS SERIES 32

- Double-acting
- ✱ Single-acting
- Non-rotating

	Ø20	Ø25	Ø32	Ø40	Ø50	Ø63	Ø80	Ø100
Standard Stroke								
5	■ ✱ ●	■ ✱ ●	■ ✱ ●	■ ✱ ●				
10	■ ✱ ●	■ ✱ ●	■ ✱ ●	■ ✱ ●	■ ✱ ●	■ ✱ ●	■ ✱ ●	■ ✱ ●
15	■ ✱ ●	■ ✱ ●	■ ✱ ●	■ ✱ ●	■ ✱ ●	■ ✱ ●	■ ✱ ●	■ ✱ ●
20	■ ✱ ●	■ ✱ ●	■ ✱ ●	■ ✱ ●	■ ✱ ●	■ ✱ ●	■ ✱ ●	■ ✱ ●
25	■ ✱ ●	■ ✱ ●	■ ✱ ●	■ ✱ ●	■ ✱ ●	■ ✱ ●	■ ✱ ●	■ ✱ ●
30	■ ●	■ ●	■ ●	■ ●	■ ●	■ ●	■ ●	■ ●
40	■ ●	■ ●	■ ●	■ ●	■ ●	■ ●	■ ●	■ ●
50	■ ●	■ ●	■ ●	■ ●	■ ●	■ ●	■ ●	■ ●
60			■ ●	■ ●	■ ●	■ ●	■ ●	■ ●
75			■ ●	■ ●	■ ●	■ ●	■ ●	■ ●
80			■ ●	■ ●	■ ●	■ ●	■ ●	■ ●
100			■ ●	■ ●	■ ●	■ ●	■ ●	■ ●

CODING EXAMPLE

32	M	2	A	032	A	050	-
-----------	----------	----------	----------	------------	----------	------------	----------

32	SERIES: 32 compact magnetic	032	BORE: 20, 25, 32, 40, 50, 63, 80, 100mm
M	VERSION: M = male rod thread F = female rod thread R = non-rotation with flange	A	CONSTRUCTION: A = standard
2	OPERATION: 1 = single-acting front spring 2 = double-acting 3 = double-acting through-rod 4 = single-acting rear spring	050	STROKE: (see table)
A	MATERIALS: A = Anodized aluminium body, end-blocks and piston, PU rod seal, end-covers OR and piston seal	-	SPECIAL: V = rod seals in viton W = seals in viton for high temperatures (140°C) double acting non magnetic

NOTE: Rod nuts and accessories are supplied separately.

- ✓ Ex Stock
- 🔧 UK Assembly
- ☎ Please Call Sales Office

ACCESSORIES

REED SWITCH	SWITCH MOUNTING BRACKET	BANJO FLOW CONTROL	BANJO RING FITTING	STRAIGHT CONNECTION	ELBOW FITTING
-------------	-------------------------	--------------------	--------------------	---------------------	---------------



Part Number	Availability	Bore	Port Size
-------------	--------------	------	-----------

Single-Acting. Male Rod Thread

32M1A020*	🔧	20	M5
32M1A025*	🔧	25	M5
32M1A032*	🔧	32	1/8
32M1A040*	🔧	40	1/8
32M1A050*	🔧	50	1/8
32M1A063*	🔧	63	1/8
32M1A080*	🔧	80	1/8
32M1A100*	🔧	100	1/8

Single-Acting. Female Rod Thread

32F1A020*	🔧	20	M5
32F1A025*	🔧	25	M5
32F1A032*	🔧	32	1/8
32F1A040*	🔧	40	1/8
32F1A050*	🔧	50	1/8
32F1A063*	🔧	63	1/8
32F1A080*	🔧	80	1/8
32F1A100*	🔧	100	1/8

Double-Acting. Male Rod Thread

32M2A020*	🔧	20	M5
32M2A025*	🔧	25	M5
32M2A032*	🔧	32	1/8
32M2A040*	🔧	40	1/8
32M2A050*	🔧	50	1/8
32M2A063*	🔧	63	1/8
32M2A080*	🔧	80	1/8
32M2A100*	🔧	100	1/8

Double-Acting. Female Rod Thread

32F2A020*	🔧	20	M5
32F2A025*	🔧	25	M5
32F2A032*	🔧	32	1/8
32F2A040*	🔧	40	1/8
32F2A050*	🔧	50	1/8
32F2A063*	🔧	63	1/8
32F2A080*	🔧	80	1/8
32F2A100*	🔧	100	1/8

Double-Acting. Non-Rotating

32R2A020*	🔧	20	M5
32R2A025*	🔧	25	M5
32R2A032*	🔧	32	1/8
32R2A040*	🔧	40	1/8
32R2A050*	🔧	50	1/8
32R2A063*	🔧	63	1/8
32R2A080*	🔧	80	1/8
32R2A100*	🔧	100	1/8

SKR2C01200	Direct Mount	SCU 602-M5	6610 4-M6	6512 4-M5	6522 4-M5
SKR2C01200	Direct Mount	SCU 602-M5	6610 4-M6	6512 4-M5	6522 4-M5
SKR2C01200	Direct Mount	SCU 604-1/8	6610 6-1/8	S6510 6-1/8	S6520 6-1/8
SKR2C01200	Direct Mount	SCU 604-1/8	6610 6-1/8	S6510 6-1/8	S6520 6-1/8
SKR2C01200	Direct Mount	SCU 604-1/8	6610 6-1/8	S6510 6-1/8	S6520 6-1/8
SKR2C01200	Direct Mount	SCU 604-1/8	6610 6-1/8	S6510 6-1/8	S6520 6-1/8
SKR2C01200	Direct Mount	SCU 604-1/8	6610 8-1/8	S6510 8-1/8	S6520 8-1/8
SKR2C01200	Direct Mount	SCU 604-1/8	6610 8-1/8	S6510 8-1/8	S6520 8-1/8

SKR2C01200	Direct Mount	SCU 602-M5	6610 4-M6	6512 4-M5	6522 4-M5
SKR2C01200	Direct Mount	SCU 602-M5	6610 4-M6	6512 4-M5	6522 4-M5
SKR2C01200	Direct Mount	SCU 604-1/8	6610 6-1/8	S6510 6-1/8	S6520 6-1/8
SKR2C01200	Direct Mount	SCU 604-1/8	6610 6-1/8	S6510 6-1/8	S6520 6-1/8
SKR2C01200	Direct Mount	SCU 604-1/8	6610 6-1/8	S6510 6-1/8	S6520 6-1/8
SKR2C01200	Direct Mount	SCU 604-1/8	6610 6-1/8	S6510 6-1/8	S6520 6-1/8
SKR2C01200	Direct Mount	SCU 604-1/8	6610 8-1/8	S6510 8-1/8	S6520 8-1/8
SKR2C01200	Direct Mount	SCU 604-1/8	6610 8-1/8	S6510 8-1/8	S6520 8-1/8

SKR2C01200	Direct Mount	SCU 602-M5	6610 4-M6	6512 4-M5	6522 4-M5
SKR2C01200	Direct Mount	SCU 602-M5	6610 4-M6	6512 4-M5	6522 4-M5
SKR2C01200	Direct Mount	SCU 604-1/8	6610 6-1/8	S6510 6-1/8	S6520 6-1/8
SKR2C01200	Direct Mount	SCU 604-1/8	6610 6-1/8	S6510 6-1/8	S6520 6-1/8
SKR2C01200	Direct Mount	SCU 604-1/8	6610 6-1/8	S6510 6-1/8	S6520 6-1/8
SKR2C01200	Direct Mount	SCU 604-1/8	6610 6-1/8	S6510 6-1/8	S6520 6-1/8
SKR2C01200	Direct Mount	SCU 604-1/8	6610 8-1/8	S6510 8-1/8	S6520 8-1/8
SKR2C01200	Direct Mount	SCU 604-1/8	6610 8-1/8	S6510 8-1/8	S6520 8-1/8

SKR2C01200	Direct Mount	SCU 602-M5	6610 4-M6	6512 4-M5	6522 4-M5
SKR2C01200	Direct Mount	SCU 602-M5	6610 4-M6	6512 4-M5	6522 4-M5
SKR2C01200	Direct Mount	SCU 604-1/8	6610 6-1/8	S6510 6-1/8	S6520 6-1/8
SKR2C01200	Direct Mount	SCU 604-1/8	6610 6-1/8	S6510 6-1/8	S6520 6-1/8
SKR2C01200	Direct Mount	SCU 604-1/8	6610 6-1/8	S6510 6-1/8	S6520 6-1/8
SKR2C01200	Direct Mount	SCU 604-1/8	6610 6-1/8	S6510 6-1/8	S6520 6-1/8
SKR2C01200	Direct Mount	SCU 604-1/8	6610 8-1/8	S6510 8-1/8	S6520 8-1/8
SKR2C01200	Direct Mount	SCU 604-1/8	6610 8-1/8	S6510 8-1/8	S6520 8-1/8

SKR2C01200	Direct Mount	SCU 602-M5	6610 4-M6	6512 4-M5	6522 4-M5
SKR2C01200	Direct Mount	SCU 602-M5	6610 4-M6	6512 4-M5	6522 4-M5
SKR2C01200	Direct Mount	SCU 604-1/8	6610 6-1/8	S6510 6-1/8	S6520 6-1/8
SKR2C01200	Direct Mount	SCU 604-1/8	6610 6-1/8	S6510 6-1/8	S6520 6-1/8
SKR2C01200	Direct Mount	SCU 604-1/8	6610 6-1/8	S6510 6-1/8	S6520 6-1/8
SKR2C01200	Direct Mount	SCU 604-1/8	6610 6-1/8	S6510 6-1/8	S6520 6-1/8
SKR2C01200	Direct Mount	SCU 604-1/8	6610 8-1/8	S6510 8-1/8	S6520 8-1/8
SKR2C01200	Direct Mount	SCU 604-1/8	6610 8-1/8	S6510 8-1/8	S6520 8-1/8

*Insert stroke length to complete part number

Technical Data Sheets

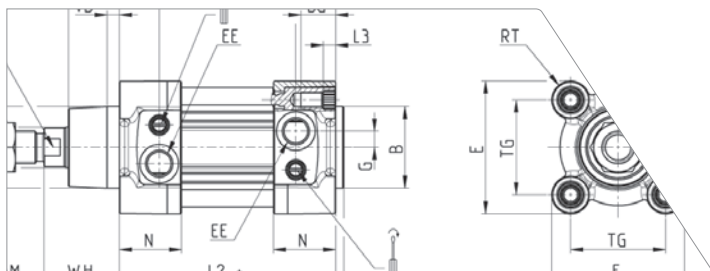

Full technical data sheets available at: <https://store.camozzi.co.uk>

Series 32 Accessories

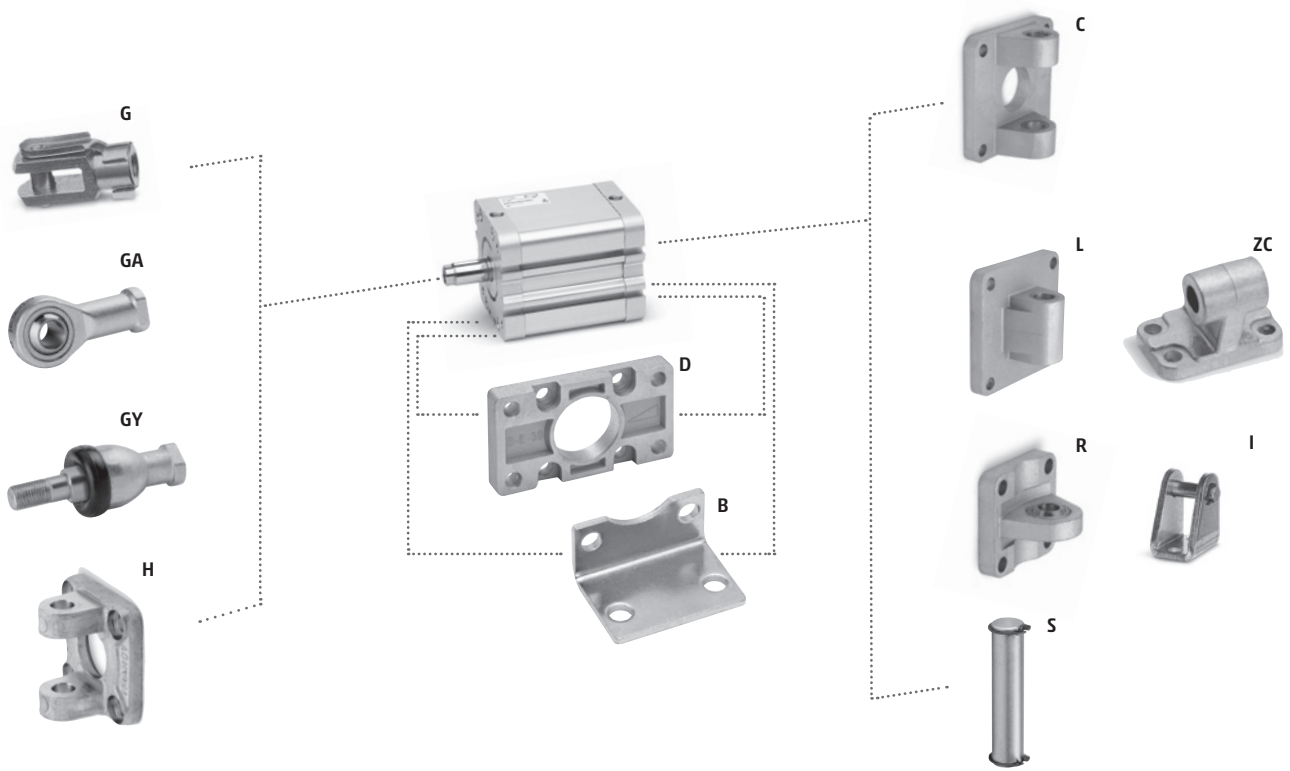

- ✓ Ex Stock
- 🔧 UK Assembly
- 📞 Please Call Sales Office

Foot Mount (pair) B	Front and Rear Flange D	Rear Trunnion, Female C	Rear Trunnion, Male L
∅	∅	∅	∅
B-32-20 20 ✓	D-E-32-20 20 ✓	C-41-32 32 ✓	L-32-20 20 ✓
B-31-25 25 ✓	D-E-32-25 25 ✓	C-41-40 40 ✓	L-32-25 25 ✓
B-41-32 32 ✓	D-E-41-32 32 ✓	C-41-50 50 ✓	L-41-32 32 ✓
B-41-40 40 ✓	D-E-41-40 40 ✓	C-H-41-63 63 ✓	L-41-40 40 ✓
B-41-50 50 ✓	D-E-41-50 50 ✓	C-H-41-80 80 ✓	L-41-50 50 ✓
B-41-63 63 ✓	D-E-41-63 63 ✓	C-H-41-100 100 ✓	L-41-63 63 ✓
B-41-80 80 ✓	D-E-41-80 80 ✓		L-41-80 80 ✓
B-41-100 100 ✓	D-E-41-100 100 ✓		L-41-100 100 ✓

Front Trunnion, Female H	90° Swivel Trunnion ZC	Rear Trunnion Ball Joint R	Rear Trunnion Bracket I
∅	(to CETOP RP 107P) ∅	∅	∅
H-41-32 32 ✓	ZC 32 32 ✓	R-41-32 32 ✓	I-20-25 20 ✓
H-41-40 40 ✓	ZC 40 40 ✓	R-41-40 40 ✓	I-20-25 25 ✓
H-41-50 50 ✓	ZC 50 50 ✓	R-41-50 50 ✓	
H-60-63 63 ✓	ZC 63 63 ✓	R-41-63 63 ✓	
C-H-41-80 80 ✓	ZC 80 80 ✓	R-41-80 80 ✓	
C-H-41-100 100 ✓	ZC 100 100 ✓	R-41-100 100 ✓	

Clevis Pin S	Rod Fork End G	Swivel Ball Joint GA	Piston Rod Socket Joint GY
∅	∅	∅	∅
S-32 32 ✓	G-20 20-25 ✓	GA-20 20-25 ✓	GY-20 20-25 ✓
S-40 40 ✓	G-25-32 32-40 ✓	GA-32 32-40 ✓	GY-32 32-40 ✓
S-50 50 ✓	G-40 50-63 ✓	GA-40 50-63 ✓	GY-40 50-63 ✓
S-63 63 ✓	G-50-63 80-100 ✓	GA-50-63 80-100 ✓	GY-50-63 80-100 ✓
S-80 80 ✓			
S-100 100 ✓			

Series 45 Guide Units

For cylinders DIN/ISO 6432: Ø 12, 16, 20, 25 mm
For cylinders DIN/ISO 6431: Ø 32, 40, 50, 63, 80, 100 mm



The Camozzi Series 45 are available in three different models depending on the applicable loads.

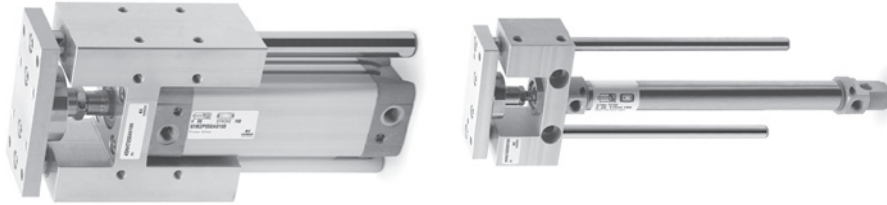

Technical Data
Operating Temperature
0°C to +80°C
(with dry air -20°C to +80°C)
Full Data Sheet and Dimensions at
<https://store.camozzi.co.uk>

PNEUMATIC ACTUATION

✓ Ex Stock ⚙ UK Assembly ☎ Please call Sales Office

Part Number	Availability	Bore
U' Self Lubricating Guide		
45NUT012A*	✓	12
45NUT016A*	✓	16
45NUT020A*	✓	20
45NUT025A*	✓	25
45NUT032A*	✓	32
45NUT040A*	✓	40
45NUT050A*	✓	50
45NUT063A*	✓	63
45NUT080A*	✓	80
45NUT100A*	✓	100

*Insert stroke length to complete part number

Part Number	Availability	Bore
H' Self Lubricating Guide		
45NHT012A*	✓	12
45NHT016A*	✓	16
45NHT020A*	✓	20
45NHT025A*	✓	25
45NHT032A*	✓	32
45NHT040A*	✓	40
45NHT050A*	✓	50
45NHT063A*	✓	63
45NHT080A*	✓	80
45NHT100A*	✓	100

*Insert stroke length to complete part number

Part Number	Availability	Bore
H' Ball Guide		
45NHB012A*	✓	12
45NHB016A*	✓	16
45NHB020A*	✓	20
45NHB025A*	✓	25
45NHB032A*	✓	32
45NHB040A*	✓	40
45NHB050A*	✓	50
45NHB063A*	✓	63
45NHB080A*	✓	80
45NHB100A*	✓	100

*Insert stroke length to complete part number

Applicable loads on 45 NUT guides depending on projection

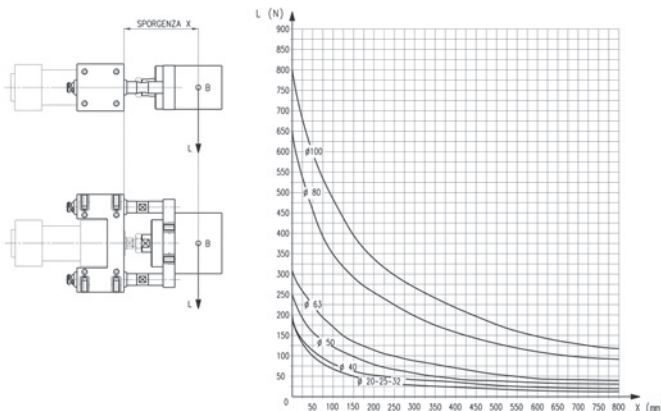

B = centre of gravity for applied load
L = load
X = fixed projection + stroke
fixed projection = distance to the centre of gravity

Applicable loads on 45 NHB and NHT guides depending on projection

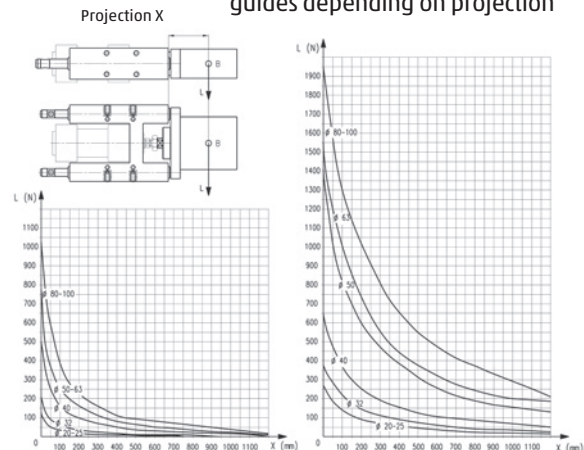

Diagram N.2 - "HB" guide with linear ball bearing (45 NHB)

Diagram N.3 - "HT" Guide moving on bush (45 NHT)

CODING EXAMPLE

45	N	UT	050	A	0100
45 SERIES: 45		UT OPERATION: UT = "U" self lubricating guide HT = "H" self lubricating guide HB = "H" ball guide		A MATERIAL: A = anodised aluminium body stainless steel columns for UT and HT hardened steel for HB	
N VERSION: N = standard		050 BORE: 12, 16, 20, 25, 32, 40, 50, 63, 80, 100mm		0100 STROKE: in mm	

Series QN Short-Stroke Cylinders

Single-acting, non magnetic
 Ø 8, 12, 20, 32, 50, 63 mm

The Camozzi short-stroke cylinder range has been designed to be installed within confined spaces.

QN1A	
Ø	Stroke
8	4
	10
12	4
	10
20	4
	10
32	5
	10
	25
50	10
	25
63	10
	25



Technical Data
Operating Pressure
 2 bar to 10 bar
Operating Temperature
 0°C to +80°C. (with dry air -20°C)
 Full Data Sheet and Dimensions at
<https://store.camozzi.co.uk>

ACCESSORIES

- ✓ Ex Stock
- 🇬🇧 UK Assembly
- 📞 Please Call Sales Office

	BANJO FLOW CONTROL	BANJO RING FITTING	STRAIGHT FITTING	ELBOW FITTING			
Part Number							
Availability							
Bore							
Port Size							
Single-Acting							
QN1A08A*	📞	8	M5	SCU 602-M5	6610 4-M6	6512 4-M5	6522 4-M5
QN1A12A*	✓	12	M5	SCU 602-M5	6610 4-M6	6512 4-M5	6522 4-M5
QN1A20A*	✓	20	M5	SCU 602-M5	6610 4-M6	6512 4-M5	6522 4-M5
QN1A32A*	✓	32	1/8	SCU 604-1/8	6610 6-1/8	6512 6-1/8	6522 6-1/8
QN1A50A*	✓	50	1/8	SCU 604-1/8	6610 6-1/8	6512 6-1/8	6522 6-1/8
QN1A63A*	📞	63	1/8	SCU 604-1/8	6610 6-1/8	6512 6-1/8	6522 6-1/8

*Insert stroke length to complete part number

CAD Drawings

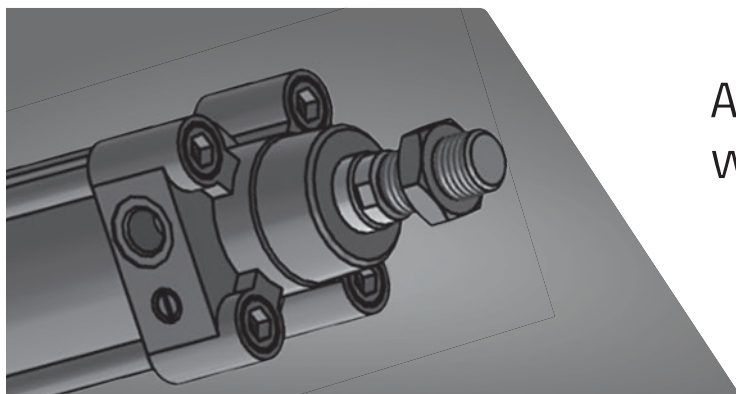

Access CAD models at:
www.camozzi.co.uk

Series QP-QPR Short-Stroke Cylinders

Series QP: Single and double-acting, magnetic
Series QPR: Double-acting magnetic, non-rotating
Ø 12, 16, 20, 25, 32, 40, 50, 63, 80, 100 mm



Technical Data

Operating Pressure
1 bar to 10 bar (double-acting)
2 bar to 10 bar (single-acting)

Operating Temperature
0°C to +80°C. (with dry air -20°C)

Full Data Sheet and Dimensions at
<https://store.camozzi.co.uk>

PNEUMATIC ACTUATION

ACCESSORIES

- ✓ Ex Stock
- 🔧 UK Assembly
- 📞 Please Call Sales Office

REED SWITCH	SWITCH MOUNTING BRACKET	BANJO FLOW CONTROL	BANJO RING FITTING	STRAIGHT FITTING	ELBOW FITTING
-------------	-------------------------	--------------------	--------------------	------------------	---------------



Part Number	Availability	Bore	Port Size
Single-Acting			
QP1A012A*	📞	12	M5
QP1A016A*	📞	16	M5
QP1A020A*	📞	20	M5
QP1A025A*	📞	25	M5
QP1A032A*	📞	32	1/8
QP1A040A*	📞	40	1/8
QP1A050A*	📞	50	1/4
QP1A063A*	📞	63	1/4
QP1A080A*	📞	80	3/8
QP1A100A*	📞	100	3/8
Double-Acting			
QP2A012A*	📞	12	M5
QP2A016A*	📞	16	M5
QP2A020A*	📞	20	M5
QP2A025A*	📞	25	M5
QP2A032A*	📞	32	1/8
QP2A040A*	📞	40	1/8
QP2A050A*	📞	50	1/4
QP2A063A*	📞	63	1/4
QP2A080A*	📞	80	3/8
QP2A100A*	📞	100	3/8
Double-Acting, Non-Rotating			
QPR2A012A*	📞	12	M5
QPR2A016A*	📞	16	M5
QPR2A020A*	📞	20	M5
QPR2A025A*	📞	25	M5
QPR2A032A*	📞	32	1/8
QPR2A040A*	📞	40	1/8
QPR2A050A*	📞	50	1/4
QPR2A063A*	📞	63	1/4
QPR2A080A*	📞	80	3/8
QPR2A100A*	📞	100	3/8

REED SWITCH	SWITCH MOUNTING BRACKET	BANJO FLOW CONTROL	BANJO RING FITTING	STRAIGHT FITTING	ELBOW FITTING
CSV-220	Direct Mount	SCU 602-M5	6610 4-M6	6512 4-M5	6522 4-M5
CSV-220	Direct Mount	SCU 602-M5	6610 4-M6	6512 4-M5	6522 4-M5
SKR2C01200	SZR12	SCU 602-M5	6610 4-M6	6512 4-M5	6522 4-M5
SKR2C01200	SZR12	SCU 602-M5	6610 4-M6	6512 4-M5	6522 4-M5
SKR2C01200	SZR12	SCU 604-1/8	6610 6-1/8	S6510 6-1/8	S6520 6-1/8
SKR2C01200	SZR12	SCU 604-1/8	6610 6-1/8	S6510 6-1/8	S6520 6-1/8
SKR2C01200	SZR12	SCU 604-1/4	6610 8-1/4	S6510 8-1/4	S6520 8-1/4
SKR2C01200	SZR12	SCU 604-1/4	6610 8-1/4	S6510 8-1/4	S6520 8-1/4
SKR2C01200	SZR12	SCU 608-3/8	6610 8-3/8	S6510 8-3/8	S6520 8-3/8
SKR2C01200	SZR12	SCU 608-3/8	6610 8-3/8	S6510 8-3/8	S6520 8-3/8
CSV-220	Direct Mount	SCU 602-M5	6610 4-M6	6512 4-M5	6522 4-M5
CSV-220	Direct Mount	SCU 602-M5	6610 4-M6	6512 4-M5	6522 4-M5
SKR2C01200	SZR12	SCU 602-M5	6610 4-M6	6512 4-M5	6522 4-M5
SKR2C01200	SZR12	SCU 602-M5	6610 4-M6	6512 4-M5	6522 4-M5
SKR2C01200	SZR12	SCU 604-1/8	6610 6-1/8	S6510 6-1/8	S6520 6-1/8
SKR2C01200	SZR12	SCU 604-1/8	6610 6-1/8	S6510 6-1/8	S6520 6-1/8
SKR2C01200	SZR12	SCU 604-1/4	6610 8-1/4	S6510 8-1/4	S6520 8-1/4
SKR2C01200	SZR12	SCU 604-1/4	6610 8-1/4	S6510 8-1/4	S6520 8-1/4
SKR2C01200	SZR12	SCU 608-3/8	6610 8-3/8	S6510 8-3/8	S6520 8-3/8
SKR2C01200	SZR12	SCU 608-3/8	6610 8-3/8	S6510 8-3/8	S6520 8-3/8

*Insert stroke length to complete part number

STANDARD STROKE FOR COMPACT MAGNETIC CYLINDERS

■ Double-acting - QP2A ✕ Single-acting - QP1A ● Non-rotating - QPR2A

	ø12	ø16	ø20	ø25	ø32	ø40	ø50	ø63	ø80	ø100
Standard Stroke										
5	■ ✕ ●	■ ✕ ●	■ ✕ ●	■ ✕ ●	■ ✕ ●	■ ✕ ●	■ ✕ ●	■ ✕ ●	■ ✕ ●	■ ✕ ●
10	■ ✕ ●	■ ✕ ●	■ ✕ ●	■ ✕ ●	■ ✕ ●	■ ✕ ●	■ ✕ ●	■ ✕ ●	■ ✕ ●	■ ✕ ●
15	■ ✕ ●	■ ✕ ●	■ ✕ ●	■ ✕ ●	■ ✕ ●	■ ✕ ●	■ ✕ ●	■ ✕ ●	■ ✕ ●	■ ✕ ●
20	■ ✕	■ ✕ ●	■ ✕ ●	■ ✕ ●	■ ✕ ●	■ ✕ ●	■ ✕ ●	■ ✕ ●	■ ✕ ●	■ ✕ ●
25	■ ✕ ●	■ ✕ ●	■ ✕ ●	■ ✕ ●	■ ✕ ●	■ ✕ ●	■ ✕ ●	■ ✕ ●	■ ✕ ●	■ ✕ ●
30	■ ●	■ ●	■ ●	■ ●	■ ●	■ ●	■ ●	■ ●	■ ●	■ ●
35	■	■ ●	■ ●	■ ●	■ ●	■ ●	■ ●	■ ●	■ ●	■ ●
40	■	■ ●	■ ●	■ ●	■ ●	■ ●	■ ●	■ ●	■ ●	■ ●
45	■	■ ●	■ ●	■ ●	■ ●	■ ●	■ ●	■ ●	■ ●	■ ●
50		■ ●	■ ●	■ ●	■ ●	■ ●	■ ●	■ ●	■ ●	■ ●
60		■ ●	■ ●	■ ●	■ ●	■ ●	■ ●	■ ●	■ ●	■ ●
75		■ ●	■ ●	■ ●	■ ●	■ ●	■ ●	■ ●	■ ●	■ ●
80		■ ●	■ ●	■ ●	■ ●	■ ●	■ ●	■ ●	■ ●	■ ●
100		■ ●	■ ●	■ ●	■ ●	■ ●	■ ●	■ ●	■ ●	■ ●

NOTE: Foot (model B) and Male Trunnion (model L) brackets available on request. ø32, 40, 50, 63, 80, 100mm

CODING EXAMPLE

QP	2	A	050	A	050
QP SERIES: QP = standard QPR = standard non-rotating	2 OPERATION: 1 = single-acting front spring (only QP) 2 = double-acting 3 = double-acting through-rod	A MATERIALS: A = rolled stainless steel rod - AL tube profile	050 BORE: 12, 16, 20, 25, 32, 40, 50, 63, 80, 100mm	A TYPE OF MOUNTING: A = standard	050 STROKE: (see table) = standard V = rod seal FKM W = All FKM seals (ø12 excepted)

Series 31 Compact Cylinders

Single-acting and Double-acting (31M-31F)
Double-acting, non-rotating (31R)
Ø 12, 16, 20, 25 mm,
Ø 32, 40, 50, 63, 80, 100 mm UNITOP



Also available in tandem and multi-position versions

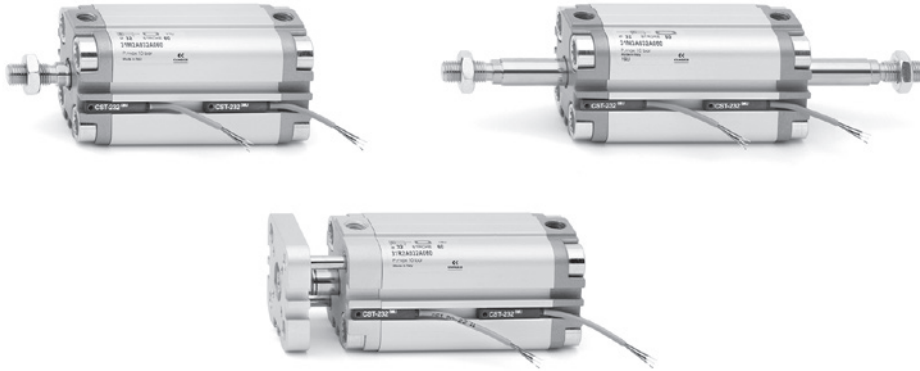

Technical Data

Operating Pressure
1 bar to 10 bar (double-acting)
2 bar to 10 bar (single-acting)

Operating Temperature
0°C to +80°C.
(with dry air -20°C)

Full Data Sheet and Dimensions at
<https://store.camozzi.co.uk>

PNEUMATIC ACTUATION

Double-acting, Single-acting and Non-rotating (through rod and non-standard strokes available on request)

STANDARD STROKES FOR CYLINDERS SERIES 31

- Double-acting
- * Single-acting
- Non-rotating

	Ø12	Ø16	Ø20	Ø25	Ø32	Ø40	Ø50	Ø63	Ø80	Ø100
Standard Stroke										
5	■*●	■*●	■*●	■*●	■*●	■*●				
10	■*●	■*●	■*●	■*●	■*●	■*●	■*●	■*●	■*●	■*●
15	●	■*●	■*●	■*●	■*●	■*●	■*●	■*●	■*●	■*●
20	●	■*●	■*●	■*●	■*●	■*●	■*●	■*●	■*●	■*●
25	●	■*●	■*●	■*●	■*●	■*●	■*●	■*●	■*●	■*●
30	●	●	●	●	●	●	●	●	●	●
40	●	●	●	●	●	●	●	●	●	●
50			●	●	●	●	●	●	●	●
60							●	●	●	●
80							●	●	●	●

CODING EXAMPLE

31	M	2	A	032	A	050	-
-----------	----------	----------	----------	------------	----------	------------	----------

31	SERIES: 31	032	BORE: 12, 16, 20, 25, 32, 40, 50, 63, 80, 100mm
M	VERSION: M = male rod thread F = female rod thread R = non-rotation with flange	A	CONSTRUCTION: A = standard
2	OPERATION: 1 = single-acting front spring 2 = double-acting 3 = double-acting through-rod 4 = single-acting rear spring	050	STROKE: (see table)
A	MATERIALS: A = rolled stainless steel rod AISI 303, tube profile aluminium		= standard S = special V = rod seal FKM W = seals in FKM for high temperatures (140°) double-acting, non magnetic

NOTE: Rod nuts and accessories are supplied separately.

ACCESSORIES

- ✓ Ex Stock
- 🔧 UK Assembly
- 📞 Please Call Sales Office

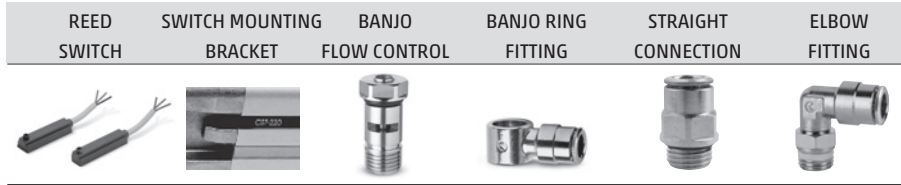

Part Number	Availability	Bore	Port Size	REED SWITCH	SWITCH MOUNTING BRACKET	BANJO FLOW CONTROL	BANJO RING FITTING	STRAIGHT CONNECTION	ELBOW FITTING
Single-Acting. Male Rod Thread									
31M1A012*	🔧	12	M5	SKR2C01200	Direct Mount	SCU 602-M5	6610 4-M6	6512 4-M5	6522 4-M5
31M1A016*	🔧	16	M5	SKR2C01200	Direct Mount	SCU 602-M5	6610 4-M6	6512 4-M5	6522 4-M5
31M1A020*	🔧	20	M5	SKR2C01200	Direct Mount	SCU 602-M5	6610 4-M6	6512 4-M5	6522 4-M5
31M1A025*	🔧	25	M5	SKR2C01200	Direct Mount	SCU 602-M5	6610 4-M6	6512 4-M5	6522 4-M5
31M1A032*	🔧	32	1/8	SKR2C01200	Direct Mount	SCU 604-1/8	6610 6-1/8	S6510 6-1/8	S6520 6-1/8
31M1A040*	🔧	40	1/8	SKR2C01200	Direct Mount	SCU 604-1/8	6610 6-1/8	S6510 6-1/8	S6520 6-1/8
31M1A050*	🔧	50	1/8	SKR2C01200	Direct Mount	SCU 604-1/8	6610 6-1/8	S6510 6-1/8	S6520 6-1/8
31M1A063*	🔧	63	1/8	SKR2C01200	Direct Mount	SCU 604-1/8	6610 6-1/8	S6510 6-1/8	S6520 6-1/8
31M1A080*	🔧	80	1/8	SKR2C01200	Direct Mount	SCU 604-1/8	6610 8-1/8	S6510 8-1/8	S6520 8-1/8
31M1A100*	🔧	100	1/4	SKR2C01200	Direct Mount	SCU 604-1/4	6610 8-1/4	S6510 8-1/4	S6520 8-1/4
Single-Acting. Female Rod Thread									
31F1A012*	🔧	12	M5	SKR2C01200	Direct Mount	SCU 602-M5	6610 4-M6	6512 4-M5	6522 4-M5
31F1A016*	🔧	16	M5	SKR2C01200	Direct Mount	SCU 602-M5	6610 4-M6	6512 4-M5	6522 4-M5
31F1A020*	🔧	20	M5	SKR2C01200	Direct Mount	SCU 602-M5	6610 4-M6	6512 4-M5	6522 4-M5
31F1A025*	🔧	25	M5	SKR2C01200	Direct Mount	SCU 602-M5	6610 4-M6	6512 4-M5	6522 4-M5
31F1A032*	🔧	32	1/8	SKR2C01200	Direct Mount	SCU 604-1/8	6610 6-1/8	S6510 6-1/8	S6520 6-1/8
31F1A040*	🔧	40	1/8	SKR2C01200	Direct Mount	SCU 604-1/8	6610 6-1/8	S6510 6-1/8	S6520 6-1/8
31F1A050*	🔧	50	1/8	SKR2C01200	Direct Mount	SCU 604-1/8	6610 6-1/8	S6510 6-1/8	S6520 6-1/8
31F1A063*	🔧	63	1/8	SKR2C01200	Direct Mount	SCU 604-1/8	6610 6-1/8	S6510 6-1/8	S6520 6-1/8
31F1A080*	🔧	80	1/8	SKR2C01200	Direct Mount	SCU 604-1/8	6610 8-1/8	S6510 8-1/8	S6520 8-1/8
31F1A100*	🔧	100	1/4	SKR2C01200	Direct Mount	SCU 604-1/4	6610 8-1/4	S6510 8-1/4	S6520 8-1/4
Double-Acting. Male Rod Thread									
31M2A012*	🔧	12	M5	SKR2C01200	Direct Mount	SCU 602-M5	6610 4-M6	6512 4-M5	6522 4-M5
31M2A016*	🔧	16	M5	SKR2C01200	Direct Mount	SCU 602-M5	6610 4-M6	6512 4-M5	6522 4-M5
31M2A020*	🔧	20	M5	SKR2C01200	Direct Mount	SCU 602-M5	6610 4-M6	6512 4-M5	6522 4-M5
31M2A025*	🔧	25	M5	SKR2C01200	Direct Mount	SCU 602-M5	6610 4-M6	6512 4-M5	6522 4-M5
31M2A032*	🔧	32	1/8	SKR2C01200	Direct Mount	SCU 604-1/8	6610 6-1/8	S6510 6-1/8	S6520 6-1/8
31M2A040*	🔧	40	1/8	SKR2C01200	Direct Mount	SCU 604-1/8	6610 6-1/8	S6510 6-1/8	S6520 6-1/8
31M2A050*	🔧	50	1/8	SKR2C01200	Direct Mount	SCU 604-1/8	6610 6-1/8	S6510 6-1/8	S6520 6-1/8
31M2A063*	🔧	63	1/8	SKR2C01200	Direct Mount	SCU 604-1/8	6610 6-1/8	S6510 6-1/8	S6520 6-1/8
31M2A080*	🔧	80	1/8	SKR2C01200	Direct Mount	SCU 604-1/8	6610 8-1/8	S6510 8-1/8	S6520 8-1/8
31M2A100*	🔧	100	1/4	SKR2C01200	Direct Mount	SCU 604-1/4	6610 8-1/4	S6510 8-1/4	S6520 8-1/4
Double-Acting. Female Rod Thread									
31F2A012*	🔧	12	M5	SKR2C01200	Direct Mount	SCU 602-M5	6610 4-M6	6512 4-M5	6522 4-M5
31F2A016*	🔧	16	M5	SKR2C01200	Direct Mount	SCU 602-M5	6610 4-M6	6512 4-M5	6522 4-M5
31F2A020*	🔧	20	M5	SKR2C01200	Direct Mount	SCU 602-M5	6610 4-M6	6512 4-M5	6522 4-M5
31F2A025*	🔧	25	M5	SKR2C01200	Direct Mount	SCU 602-M5	6610 4-M6	6512 4-M5	6522 4-M5
31F2A032*	🔧	32	1/8	SKR2C01200	Direct Mount	SCU 604-1/8	6610 6-1/8	S6510 6-1/8	S6520 6-1/8
31F2A040*	🔧	40	1/8	SKR2C01200	Direct Mount	SCU 604-1/8	6610 6-1/8	S6510 6-1/8	S6520 6-1/8
31F2A050*	🔧	50	1/8	SKR2C01200	Direct Mount	SCU 604-1/8	6610 6-1/8	S6510 6-1/8	S6520 6-1/8
31F2A063*	🔧	63	1/8	SKR2C01200	Direct Mount	SCU 604-1/8	6610 6-1/8	S6510 6-1/8	S6520 6-1/8
31F2A080*	🔧	80	1/8	SKR2C01200	Direct Mount	SCU 604-1/8	6610 8-1/8	S6510 8-1/8	S6520 8-1/8
31F2A100*	🔧	100	1/4	SKR2C01200	Direct Mount	SCU 604-1/4	6610 8-1/4	S6510 8-1/4	S6520 8-1/4
Double-Acting. Non-Rotating									
31R2A012*	🔧	12	M5	SKR2C01200	Direct Mount	SCU 602-M5	6610 4-M6	6512 4-M5	6522 4-M5
31R2A016*	🔧	16	M5	SKR2C01200	Direct Mount	SCU 602-M5	6610 4-M6	6512 4-M5	6522 4-M5
31R2A020*	🔧	20	M5	SKR2C01200	Direct Mount	SCU 602-M5	6610 4-M6	6512 4-M5	6522 4-M5
31R2A025*	🔧	25	M5	SKR2C01200	Direct Mount	SCU 602-M5	6610 4-M6	6512 4-M5	6522 4-M5
31R2A032*	🔧	32	1/8	SKR2C01200	Direct Mount	SCU 604-1/8	6610 6-1/8	S6510 6-1/8	S6520 6-1/8
31R2A040*	🔧	40	1/8	SKR2C01200	Direct Mount	SCU 604-1/8	6610 6-1/8	S6510 6-1/8	S6520 6-1/8
31R2A050*	🔧	50	1/8	SKR2C01200	Direct Mount	SCU 604-1/8	6610 6-1/8	S6510 6-1/8	S6520 6-1/8
31R2A063*	🔧	63	1/8	SKR2C01200	Direct Mount	SCU 604-1/8	6610 6-1/8	S6510 6-1/8	S6520 6-1/8
31R2A080*	🔧	80	1/8	SKR2C01200	Direct Mount	SCU 604-1/8	6610 8-1/8	S6510 8-1/8	S6520 8-1/8
31R2A100*	🔧	100	1/4	SKR2C01200	Direct Mount	SCU 604-1/4	6610 8-1/4	S6510 8-1/4	S6520 8-1/4

*Insert stroke length to complete part number

Series 31 Accessories

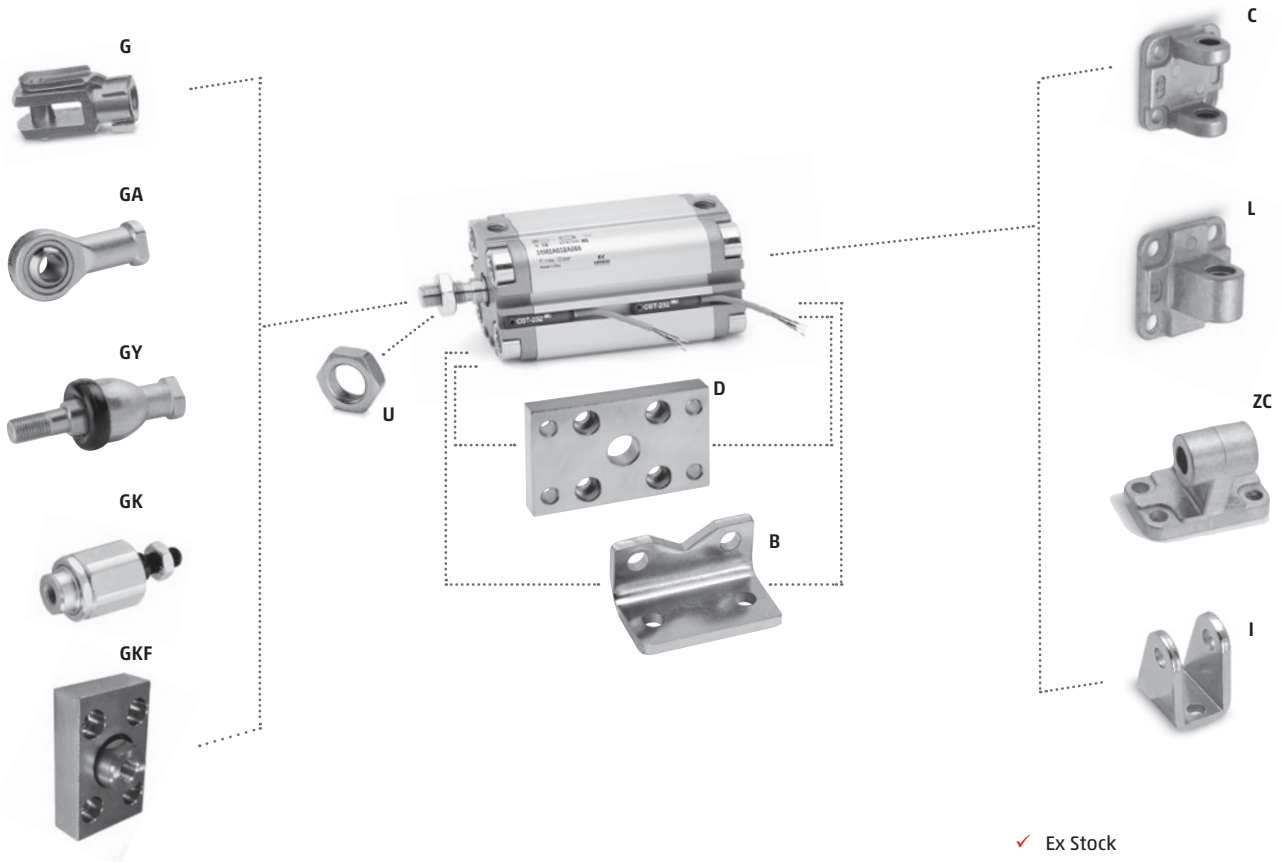

- ✓ Ex Stock
- 🔧 UK Assembly
- 📞 Please Call Sales Office

Foot Mounts (pair) B		Front and Rear Flange D		Rear Trunnion, Female C		Rear Trunnion, Male L	
∅		∅		∅		∅	
B-31-12-16	12-16 ✓	D-E-31-12-16	12-16 ✓	C-31-32	32 ✓	L-31-12-16	12 ✓
B-31-20	20 ✓	D-E-31-20	20 ✓	C-31-40	40 ✓	L-31-12-16	16 ✓
B-31-25	25 ✓	D-E-31-25	25 ✓	C-31-50	50 ✓	L-31-20	20 ✓
B-31-32	32 ✓	D-E-31-32	32 ✓	C-31-63	63 ✓	L-31-25	25 ✓
B-31-40	40 ✓	D-E-31-40	40 ✓	C-31-80	80 ✓		
B-31-50	50 ✓	D-E-31-50	50 ✓	C-31-100	100 ✓		
B-31-63	63 ✓	D-E-31-63	63 ✓				
B-31-80	80 ✓	D-E-31-80	80 ✓				
B-31-100	100 ✓	D-E-31-100	100 ✓				
				Note: Pin Included			
90° Swivel Trunnion ZC		90° Swivel Combination for I		Rod Fork End G		Swivel Ball Joint GA	
∅		∅		∅		∅	
ZC-32	32 ✓	I-12-16	12 ✓	G-12-16	12 ✓	GA-12-16	12 ✓
ZC-40	40 ✓	I-12-16	16 ✓	G-20	16 ✓	GA-20	16 ✓
ZC-50	50 ✓	I-20-25	20 ✓	G-25-32	20-40 ✓	GA-32	20-40 ✓
ZC-63	63 ✓	I-20-25	25 ✓	G-40	50-63 ✓	GA-40	50-63 ✓
ZC-80	80 ✓			G-50-63	80 ✓	GA-50-63	80 ✓
ZC-100	100 ✓			G-80-100	100 ✓	GA-80-100	100 ✓
Piston Rod Socket Joint GY		Self Aligning Rod GK		Coupling Piece GKF		Piston Rod Lock Nut U	
∅		∅		∅		∅	
GY-12-16	12 ✓	GK-20	16 ✓	GKF-20	16 ✓	U-12-16	12 ✓
GY-20	16 ✓	GK-25-32	20-25-32-40 ✓	GKF-25-32	20-25-32-40 ✓	U-20	16 ✓
GY-32	20-40 ✓	GK-40	50-63 ✓	GKF-40	50-63 ✓	U-25-32	20-40 ✓
GY-40	50-63 ✓	GK-50-63	80 ✓	GKF-50-63	80 ✓	U-40	50-63 ✓
GY-50-63	80 ✓	GK-80-100	100 ✓	GKF-80-100	100 ✓	U-50-63	80 ✓
GY-80-100	100 ✓					U-80-100	100 ✓

Series ST Stopper Cylinders

Single and double-acting, magnetic, non-rotating
 Sizes 20, 32, 40, 50 mm



Technical Data
Operating Pressure
 1 bar to 10 bar (double-acting)
 2 bar to 10 bar (single-acting)
Operating Temperature
 0°C to +80°C.
 (with dry air -20°C)
 Full Data Sheet and Dimensions at
<https://store.camozzi.co.uk>

STANDARD STROKES FOR CYLINDERS SERIES ST

* Single-acting and Double-acting

	ST31			ST32			
	ø20	ø32	ø50	ø20	ø32	ø40	ø50
Standard Stroke							
10				*			
15	*			*	*		
20		*			*	*	*
25					*	*	*
30			*			*	*

CODING EXAMPLE

ST	31	2	A	050	A	030
-----------	-----------	----------	----------	------------	----------	------------

ST	SERIES: ST	050	BORE: 20, 32, 40 (ST32 only), 50mm
31	VERSION: 31 = UNITOP 32 = ISO 21287	A	CONSTRUCTION: A = standard R = with roller (for non-rotating version only) F = with female thread (ST32 only)
2	OPERATION: 2 = double-acting 4 = single-acting rear spring 9 = double-acting rear spring	030	STROKE: (see table)
A	DESIGN: A = standard R = non-rotating (ST32 only)		VERSION: = standard (_ _ _) = extended piston rod _ _ _ mm

NOTE: Rod nuts and accessories are supplied separately.

- ✓ Ex Stock
- 🔧 UK Assembly
- ☎ Please Call Sales Office

ACCESSORIES

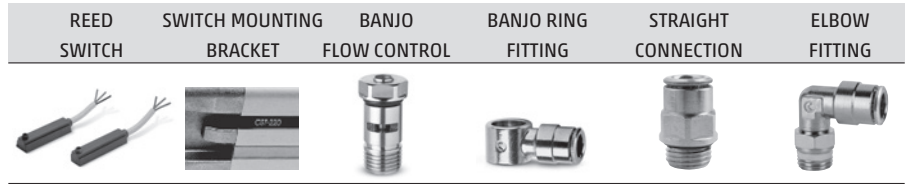

Part Number	Availability	Bore	Port Size
UNITOP. Double-Acting. Standard			
ST312A020A*	☉	20	1/8
ST312A032A*	☉	32	1/8
ST312A050A*	☉	50	1/8
UNITOP. Single-Acting. Rear Spring. Standard			
ST314A020A*	☉	20	1/8
ST314A032A*	☉	32	1/8
ST314A050A*	☉	50	1/8
UNITOP. Double-Acting. Rear Spring. Standard			
ST319A020A*	☉	20	1/8
ST319A032A*	☉	32	1/8
ST319A050A*	☉	50	1/8
ISO 21278. Double-Acting. Standard			
ST322A020A*	☉	20	M5
ST322A032A*	☉	32	1/8
ST322A040A*	☉	40	1/8
ST322A050A*	☉	50	1/8
ISO 21278. Double-Acting. Non-Rotating			
ST322R020A*	☉	20	M5
ST322R032A*	☉	32	1/8
ST322R040A*	☉	40	1/8
ST322R050A*	☉	50	1/8
ISO 21278. Single-Acting. Rear Spring. Standard			
ST324A020A*	☉	20	M5
ST324A032A*	☉	32	1/8
ST324A040A*	☉	40	1/8
ST324A050A*	☉	50	1/8
ISO 21278. Single-Acting. Rear Spring. Non-Rotating			
ST324R020A*	☉	20	M5
ST324R032A*	☉	32	1/8
ST324R040A*	☉	40	1/8
ST324R050A*	☉	50	1/8
ISO 21278. Double-Acting. Rear Spring. Standard			
ST329A020A*	☉	20	M5
ST329A032A*	☉	32	1/8
ST329A040A*	☉	40	1/8
ST329A050A*	☉	50	1/8
ISO 21278. Double-Acting. Rear Spring. Non-Rotating			
ST329R020A*	☉	20	M5
ST329R032A*	☉	32	1/8
ST329R040A*	☉	40	1/8
ST329R050A*	☉	50	1/8

Part Number	Availability	Bore	Port Size	REED SWITCH	SWITCH MOUNTING BRACKET	BANJO FLOW CONTROL	BANJO RING FITTING	STRAIGHT CONNECTION	ELBOW FITTING
SKR2C01200	☉	20	1/8	☐	☐	☐	☐	☐	☐
SKR2C01200	☉	32	1/8	☐	☐	☐	☐	☐	☐
SKR2C01200	☉	50	1/8	☐	☐	☐	☐	☐	☐
SKR2C01200	☉	20	1/8	☐	☐	☐	☐	☐	☐
SKR2C01200	☉	32	1/8	☐	☐	☐	☐	☐	☐
SKR2C01200	☉	50	1/8	☐	☐	☐	☐	☐	☐
SKR2C01200	☉	20	1/8	☐	☐	☐	☐	☐	☐
SKR2C01200	☉	32	1/8	☐	☐	☐	☐	☐	☐
SKR2C01200	☉	50	1/8	☐	☐	☐	☐	☐	☐
SKR2C01200	☉	20	M5	☐	☐	☐	☐	☐	☐
SKR2C01200	☉	32	1/8	☐	☐	☐	☐	☐	☐
SKR2C01200	☉	40	1/8	☐	☐	☐	☐	☐	☐
SKR2C01200	☉	50	1/8	☐	☐	☐	☐	☐	☐
SKR2C01200	☉	20	M5	☐	☐	☐	☐	☐	☐
SKR2C01200	☉	32	1/8	☐	☐	☐	☐	☐	☐
SKR2C01200	☉	40	1/8	☐	☐	☐	☐	☐	☐
SKR2C01200	☉	50	1/8	☐	☐	☐	☐	☐	☐
SKR2C01200	☉	20	M5	☐	☐	☐	☐	☐	☐
SKR2C01200	☉	32	1/8	☐	☐	☐	☐	☐	☐
SKR2C01200	☉	40	1/8	☐	☐	☐	☐	☐	☐
SKR2C01200	☉	50	1/8	☐	☐	☐	☐	☐	☐

STAINLESS STEEL CYLINDERS

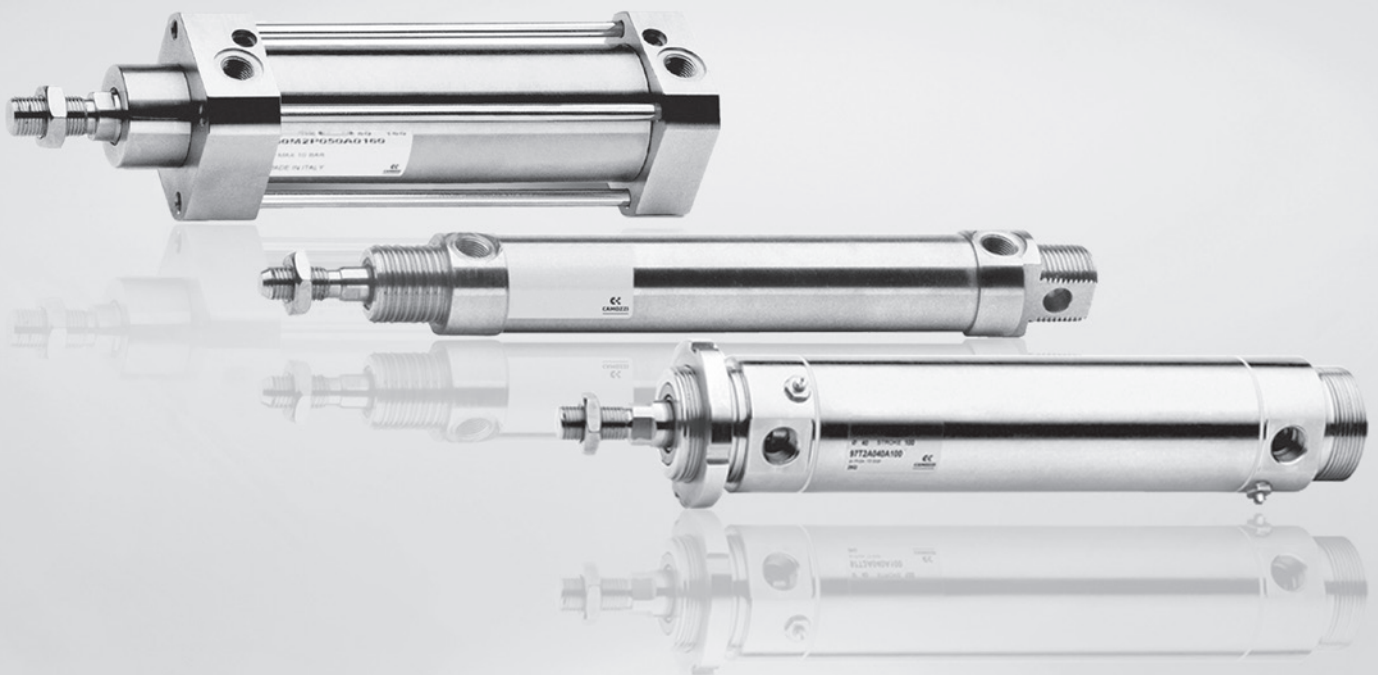

Protect Against Corrosion

Camozzi Stainless Steel pneumatic cylinders are ideal for applications where a high level of corrosion resistance is required.

Each cylinder benefits from a clean design and constructed using either 304 or 316 AISI Stainless Steel.

Series 90 – ISO 15552 (previously DIN/ ISO 6431/ VDMA 24562)

Series 94/95 – DIN/ ISO 6432

Series 97 – with adjustable end stroke cushioning

Full range of Stainless Steel mounting brackets also available

Series QCT and QCB Cylinders with Integrated Guide

Double-acting, magnetic piston, guided
Ø 20, 25, 32, 40, 50, 63 mm

The Camozzi QC compact cylinders are designed to be used in applications where space is limited and when the load must be guided to prevent rotation.



Technical Data

Operating Pressure
Min 1 bar to max 10 bar
Operating Temperature
0°C to +80°C.
(with dry air -20°C)

Full Data Sheet and Dimensions at
<https://store.camozzi.co.uk>

Double-acting QCT Type

PNEUMATIC ACTUATION

ACCESSORIES

- ✓ Ex Stock
- ✎ UK Assembly
- ⊗ Please Call Sales Office



Part Number	Availability	Bore	Port Size
Double-Acting. Sintered Bronze Bushes			
QCT2A020A*	⊗	20	1/8
QCT2A025A*	⊗	25	1/8
QCT2A032A*	⊗	32	1/8
QCT2A040A*	⊗	40	1/8
QCT2A050A*	⊗	50	1/4
QCT2A063A*	⊗	63	1/4
Double-Acting. Linear Ball Bearings			
QCB2A020A*	⊗	20	1/8
QCB2A025A*	⊗	25	1/8
QCB2A032A*	⊗	32	1/8
QCB2A040A*	⊗	40	1/8
QCB2A050A*	⊗	50	1/4
QCB2A063A*	⊗	63	1/4

REED SWITCH	SWITCH MOUNTING BRACKET	BANJO FLOW CONTROL	BANJO RING FITTING	STRAIGHT CONNECTION	ELBOW FITTING
CST-220	Direct Mount	SCU 604-1/8	6610 6-1/8	S6510 6-1/8	S6520 6-1/8
CST-220	Direct Mount	SCU 604-1/8	6610 6-1/8	S6510 6-1/8	S6520 6-1/8
CST-220	Direct Mount	SCU 604-1/8	6610 6-1/8	S6510 6-1/8	S6520 6-1/8
CST-220	Direct Mount	SCU 604-1/8	6610 6-1/8	S6510 6-1/8	S6520 6-1/8
CST-220	Direct Mount	SCU 606-1/4	6610 6-1/4	S6510 6-1/4	S6520 6-1/4
CST-220	Direct Mount	SCU 606-1/4	6610 6-1/4	S6510 6-1/4	S6520 6-1/4
CST-220	Direct Mount	SCU 604-1/8	6610 6-1/8	S6510 6-1/8	S6520 6-1/8
CST-220	Direct Mount	SCU 604-1/8	6610 6-1/8	S6510 6-1/8	S6520 6-1/8
CST-220	Direct Mount	SCU 604-1/8	6610 6-1/8	S6510 6-1/8	S6520 6-1/8
CST-220	Direct Mount	SCU 604-1/8	6610 6-1/8	S6510 6-1/8	S6520 6-1/8
CST-220	Direct Mount	SCU 606-1/4	6610 6-1/4	S6510 6-1/4	S6520 6-1/4
CST-220	Direct Mount	SCU 606-1/4	6610 6-1/4	S6510 6-1/4	S6520 6-1/4

*Insert stroke length to complete part number

STANDARD STROKES FOR CYLINDERS SERIES QC

- Double-acting

	Ø20	Ø25	Ø32	Ø40	Ø50	Ø63
Standard Stroke						
20	■	■				
25			■	■	■	■
30	■	■				
40	■	■				
50	■	■	■	■	■	■
75	■	■	■	■	■	■
100	■	■	■	■	■	■
125	■	■	■	■	■	■
150	■	■	■	■	■	■
175	■	■	■	■	■	■
200	■	■	■	■	■	■

Note: Non standard models available only on request.

CODING EXAMPLE

QC	T	2	A	020	A	050	-
QC	SERIES: QC			020	BORE: 20, 25, 32, 40, 50, 63mm		
T	VERSION: T = sintered bronze bushes B = linear ball bearings			A	TYPE OF DESIGN: A = standard		
2	OPERATION: 2 = double-acting			050	STROKE: (see table)* * Non standard models available only on request.		
A	MATERIALS: A = anodised aluminium body, stainless steel piston rod, stainless steel QCT columns, hardened steel QCB columns			-	SPECIAL: to be specified		

Series QCTF - QCBF Slide Units

Double-acting, magnetic piston, with double bearing and flanges
 Ø 20, 25, 32, 40 mm

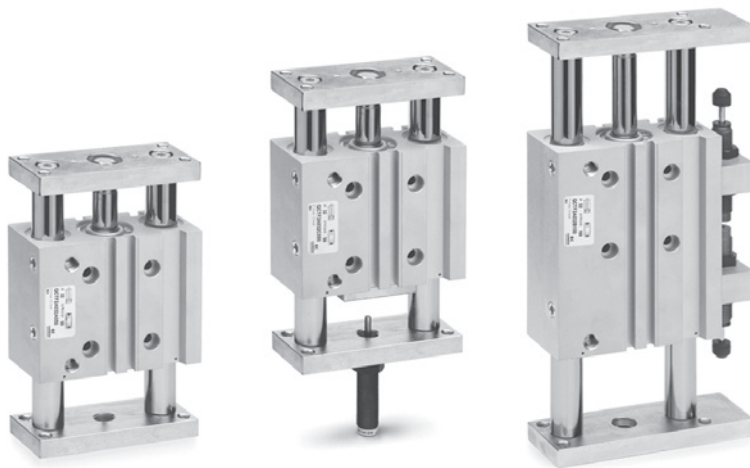

Technical Data
Operating Pressure
 Min 1 bar to max 10 bar
Operating Temperature
 0°C to +80°C.
 (with dry air -20°C)
 Full Data Sheet and Dimensions at
<https://store.camozzi.co.uk>

Part Number: QCTF2A...A...
 Part Number: QCBF2A...A...

Part Number: QCTF2A...C...
 Part Number: QCBF2A...C...

Part Number: QCTF2A...B...
 Part Number: QCBF2A...B...

ACCESSORIES

REED SWITCH	SWITCH MOUNTING BRACKET	BANJO FLOW CONTROL	BANJO RING FITTING	STRAIGHT CONNECTION	ELBOW FITTING

- ✓ Ex Stock
- ✂ UK Assembly
- ☎ Please Call Sales Office

Part Number	Availability	Bore	Port Size	CST-220	Direct Mount	SCU 604-1/8	6610 6-1/8	S6510 6-1/8	S6520 6-1/8
Double-Acting. Sintered Bronze Bushes									
QCTF2A020A*	☎	20	1/8	CST-220	Direct Mount	SCU 604-1/8	6610 6-1/8	S6510 6-1/8	S6520 6-1/8
QCTF2A025A*	☎	25	1/8	CST-220	Direct Mount	SCU 604-1/8	6610 6-1/8	S6510 6-1/8	S6520 6-1/8
QCTF2A032A*	☎	32	1/8	CST-220	Direct Mount	SCU 604-1/8	6610 6-1/8	S6510 6-1/8	S6520 6-1/8
QCTF2A040A*	☎	40	1/8	CST-220	Direct Mount	SCU 604-1/8	6610 6-1/8	S6510 6-1/8	S6520 6-1/8
Double-Acting. Linear Ball Bearings									
QCBF2A020A*	☎	20	1/8	CST-220	Direct Mount	SCU 604-1/8	6610 6-1/8	S6510 6-1/8	S6520 6-1/8
QCBF2A025A*	☎	25	1/8	CST-220	Direct Mount	SCU 604-1/8	6610 6-1/8	S6510 6-1/8	S6520 6-1/8
QCBF2A032A*	☎	32	1/8	CST-220	Direct Mount	SCU 604-1/8	6610 6-1/8	S6510 6-1/8	S6520 6-1/8
QCBF2A040A*	☎	40	1/8	CST-220	Direct Mount	SCU 604-1/8	6610 6-1/8	S6510 6-1/8	S6520 6-1/8

*Insert stroke length to complete part number
 See full catalogue or catalogue.camozzi.com for all dimensions.
 For technical advice contact our sales office or your local Camozzi distributor.

STANDARD STROKE FOR SERIES QCTF AND QCBF

- Cushioning type A and C
- * Cushioning type B

	ø20	ø25	ø32	ø40
Standard Stroke				
20	■	■		
25			■	■
30	■	■		
40	■	■		
50	■	■	■	■
75	■*	■*	■	■
100	■*	■*	■*	■*
125	■*	■*	■*	■*
150	■*	■*	■*	■*
175	■*	■*	■*	■*
200	■*	■*	■*	■*

Note: Non standard models available only on request.

CODING EXAMPLE

QC	T	F	2	A	020	A	050
QC	SERIES: QC			A	MATERIALS A = anodised aluminium body, stainless steel piston rod, stainless steel columns (QCT), hardened steel columns (QCB)		
T	TYPE OF BEARING T = sintered bronze bushes B = linear ball bearings			020	BORE 20, 25, 32, 40mm		
F	INSTALLATION TYPE F = body mounted with moving flanges			A	CUSHION A = fixed mechanical cushion (standard) B = two shock absorbers located on the body C = one shock absorber located on the rear flange		
2	OPERATION 2 = double acting			050	STROKE (see table)		

Series QX Twin Rod Cylinders

Double-acting, magnetic, guided
ø 10x2, 16x2, 20x2, 25x2, 32x2 mm



Technical Data

Operating Pressure
1 bar to 10 bar

Operating Temperature
0°C to +80°C.
(with dry air -20°C)

Full Data Sheet and Dimensions at
<https://store.camozzi.co.uk>

ACCESSORIES

- ✓ Ex Stock
- ✎ UK Assembly
- ⌚ Please Call Sales Office

REED SWITCH	SWITCH MOUNTING BRACKET	BANJO FLOW CONTROL	BANJO RING FITTING	STRAIGHT CONNECTION	ELBOW FITTING
-------------	-------------------------	--------------------	--------------------	---------------------	---------------



Part Number	Availability	Bore	Port Size	CSB-D-220	Direct Mount	SCU 602-M5	6610 4-M6	6512 4-M5	6522 4-M5
Double-Acting. Sintered Bronze Bushes									
QXT2A010A*	⌚	10	M5	CSB-D-220	Direct Mount	SCU 602-M5	6610 4-M6	6512 4-M5	6522 4-M5
QXT2A016A*	⌚	16	M5	CSB-D-220	Direct Mount	SCU 602-M5	6610 4-M6	6512 4-M5	6522 4-M5
QXT2A020A*	⌚	20	M5	CSB-D-220	Direct Mount	SCU 602-M5	6610 4-M6	6512 4-M5	6522 4-M5
QXT2A025A*	⌚	25	M5	CSB-D-220	Direct Mount	SCU 602-M5	6610 4-M6	6512 4-M5	6522 4-M5
QXT2A032A*	⌚	32	1/8	CSB-D-220	Direct Mount	SCU 604-1/8	6610 6-1/8	S6510 6-1/8	S6520 6-1/8
Double-Acting. Linear Ball Bearings									
QXB2A010A*	⌚	10	M5	CSB-D-220	Direct Mount	SCU 602-M5	6610 4-M6	6512 4-M5	6522 4-M5
QXB2A016A*	⌚	16	M5	CSB-D-220	Direct Mount	SCU 602-M5	6610 4-M6	6512 4-M5	6522 4-M5
QXB2A020A*	⌚	20	M5	CSB-D-220	Direct Mount	SCU 602-M5	6610 4-M6	6512 4-M5	6522 4-M5
QXB2A025A*	⌚	25	M5	CSB-D-220	Direct Mount	SCU 602-M5	6610 4-M6	6512 4-M5	6522 4-M5
QXB2A032A*	⌚	32	1/8	CSB-D-220	Direct Mount	SCU 604-1/8	6610 6-1/8	S6510 6-1/8	S6520 6-1/8

*Insert stroke length to complete part number

STANDARD STROKES FOR CYLINDERS SERIES QX

- Double - acting

	ø10	ø16	ø20	ø25	ø32
Standard Stroke					
10	■	■	■	■	■
20	■	■	■	■	■
30	■	■	■	■	■
40	■	■	■	■	■
50	■	■	■	■	■
75	■	■	■	■	■
100		■	■	■	■

CODING EXAMPLE

QX	T	2	A	020	A	050
QX	SERIES: QX			020	BORE 10, 16, 20, 25, 32mm	
T	VERSION T = sintered bronze bushes B = linear ball bearings			A	TYPE OF DESIGN A = standard	
2	OPERATION 2 = double acting (1 flange) radial pressure supply 3 = through-rod (double-flange), radial pressure supply			050	STROKE (see table)	
A	MATERIALS A = anodised aluminium body, rolled stainless steel piston 303 piston rod					

Series 14 Compact Mini-Cylinders

Single-acting

Ø 6, 10, 16 mm : Stroke 5, 10, 15 mm

with Super-Rapid fitting 4mm and M5 connection.

The Camozzi Series 14 cylinder range has been designed to be installed in very small spaces. The cylinders are designed to be bulkhead mounted either individually or in banks.



Technical Data

Operating Pressure
2.5 bar to 8 bar

Operating Temperature
0°C to +80°C.
(with dry air -20°C)

Full Data Sheet and Dimensions at
<https://store.camozzi.co.uk>

STANDARD STROKES FOR MINI-CYLINDERS SERIES 14

* Single-acting

	Ø6	Ø10	Ø16
Standard Stroke			
5	*	*	*
10	*	*	*
15	*	*	*

ACCESSORIES

- ✓ Ex Stock
- ✎ UK Assembly
- ☎ Please Call Sales Office

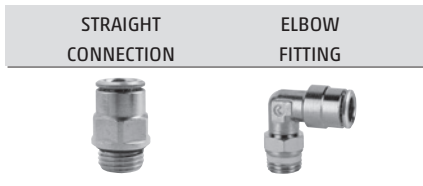

Part Number	Availability	Bore	Port Size
Single-Acting. Non Threaded Piston Rod.			
Thread Connection			
14N1M06A*	☎	6	M5
14N1M10A*	☎	10	M5
14N1M16A*	☎	16	M5
Single-Acting. Threaded Piston Rod.			
Thread Connection			
14N1M06B*	☎	6	M5
14N1M10B*	☎	10	M5
14N1M16B*	☎	16	M5

Part Number	Availability	Bore	Port Size
Single-Acting. Non Threaded Piston Rod.			
Super-Rapid Connection			
14N1A06A*	☎	6	4mm
14N1A10A*	☎	10	4mm
14N1A16A*	☎	16	4mm
Single-Acting. Threaded Piston Rod.			
Super-Rapid Connection			
14N1A06B*	☎	6	4mm
14N1A10B*	☎	10	4mm
14N1A16B*	☎	16	4mm

*Insert stroke length to complete part number

CODING EXAMPLE

14	N	1	A	06	A	05
14	SERIES: 14			06	BORE 06 = 6mm - 10 = 10mm - 16 = 16mm	
N	VERSION N = non-magnetic			A	TYPE OF DESIGN A = non-threaded piston rod B = threaded piston rod	
1	OPERATION 1 = single-acting			05	STROKE 05 = 5mm - 10 = 10mm - 15 = 15mm	
A	TYPE OF CONNECTION A = TUBE Ø4 M = thread M5					

Series 27 Roundline Cylinders

Double-acting, Magnetic
 Ø 20, 25, 32, 40, 50, 63 mm



The Camozzi Series 27 cylinder range has been designed incorporating reduced dimensions and clean lines, suitable for a wide range of industrial applications.



Technical Data
Operating Pressure
 Min 1 bar to Max 10 bar
Operating Temperature
 0°C to +80°C.
 (with dry air -20°C)
 Full Data Sheet and Dimensions at
<https://store.camozzi.co.uk>

Double-acting only (non-standard strokes available on request)

PNEUMATIC ACTUATION

ACCESSORIES

- ✓ Ex Stock
- ✎ UK Assembly
- ☎ Please Call Sales Office

REED SWITCH	SWITCH MOUNTING BRACKET	BANJO FLOW CONTROL	BANJO RING FITTING	STRAIGHT CONNECTION	ELBOW FITTING

Part Number	Availability	Bore	Port Size
Double-Acting. Model M			
27M2A20A*	✎	20	1/8
27M2A25A*	✎	25	1/8
27M2A32A*	✎	32	1/8
27M2A40A*	✎	40	1/8
Double-Acting. Model T			
27T2A20A*	✎	20	1/8
27T2A25A*	✎	25	1/8
27T2A32A*	✎	32	1/8
27T2A40A*	✎	40	1/8
Double-Acting. Model U			
27U2A20A*	✎	20	1/8
27U2A25A*	✎	25	1/8
27U2A32A*	✎	32	1/8
27U2A40A*	✎	40	1/8
27U2A50A*	✎	50	1/4
27U2A63A*	✎	63	1/4

REED SWITCH	SWITCH MOUNTING BRACKET	BANJO FLOW CONTROL	BANJO RING FITTING	STRAIGHT CONNECTION	ELBOW FITTING
SKR2C01200	SF20	SCU 604-1/8	6610 6-1/8	S6510 6-1/8	S6520 6-1/8
SKR2C01200	SF25	SCU 604-1/8	6610 6-1/8	S6510 6-1/8	S6520 6-1/8
SKR2C01200	S-CST-06	SCU 604-1/8	6610 6-1/8	S6510 6-1/8	S6520 6-1/8
SKR2C01200	S-CST-07	SCU 604-1/8	6610 6-1/8	S6510 6-1/8	S6520 6-1/8
SKR2C01200	SF20	SCU 604-1/8	6610 6-1/8	S6510 6-1/8	S6520 6-1/8
SKR2C01200	SF25	SCU 604-1/8	6610 6-1/8	S6510 6-1/8	S6520 6-1/8
SKR2C01200	S-CST-06	SCU 604-1/8	6610 6-1/8	S6510 6-1/8	S6520 6-1/8
SKR2C01200	S-CST-07	SCU 604-1/8	6610 6-1/8	S6510 6-1/8	S6520 6-1/8
SKR2C01200	SF20	SCU 604-1/8	6610 6-1/8	S6510 6-1/8	S6520 6-1/8
SKR2C01200	SF25	SCU 604-1/8	6610 6-1/8	S6510 6-1/8	S6520 6-1/8
SKR2C01200	S-CST-06	SCU 604-1/8	6610 6-1/8	S6510 6-1/8	S6520 6-1/8
SKR2C01200	S-CST-07	SCU 604-1/8	6610 6-1/8	S6510 6-1/8	S6520 6-1/8
SKR2C01200	S-CST-08	SCU 606-1/4	6610 6-1/4	S6510 6-1/4	S6520 6-1/4
SKR2C01200	S-CST-09	SCU 606-1/4	6610 6-1/4	S6510 6-1/4	S6520 6-1/4

*Insert stroke length to complete part number

STANDARD STROKES FOR CYLINDERS SERIES 27

■ Double-acting

	Ø20	Ø25	Ø32	Ø40	Ø50	Ø63
Standard Stroke						
10	■	■	■	■	■	■
25	■	■	■	■	■	■
40	■	■	■	■	■	■
50	■	■	■	■	■	■
80	■	■	■	■	■	■
100	■	■	■	■	■	■
125	■	■	■	■	■	■
160	■	■	■	■	■	■
200	■	■	■	■	■	■
250	■	■	■	■	■	■
300	■	■	■	■	■	■
320	■	■	■	■	■	■
400	■	■	■	■	■	■
500	■	■	■	■	■	■

Mod. M



Bore Sizes: 20, 25, 32, 40

Mod. T

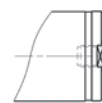

Bore Sizes: 20, 25, 32, 40

Mod. U



Bore Sizes: 20, 25, 32, 40, 50, 63

CODING EXAMPLE

27	M	2	A	20	A	0050	-
27	SERIES: 27			20	BORE: 20, 25, 32, 40, 50, 63mm		
M	VERSION: M = Standard rear end housing, trunnion hole, side port T = End ported rear housing U = Side ported rear housing			A	TYPE OF DESIGN: A = standard		
2	OPERATION: 2 = double-acting			0050	STROKE: (see table)		
A	MATERIALS: A = rolled stainless steel rod-stainless steel tube			-	SPECIAL: to be specified		

Series 27 Accessories

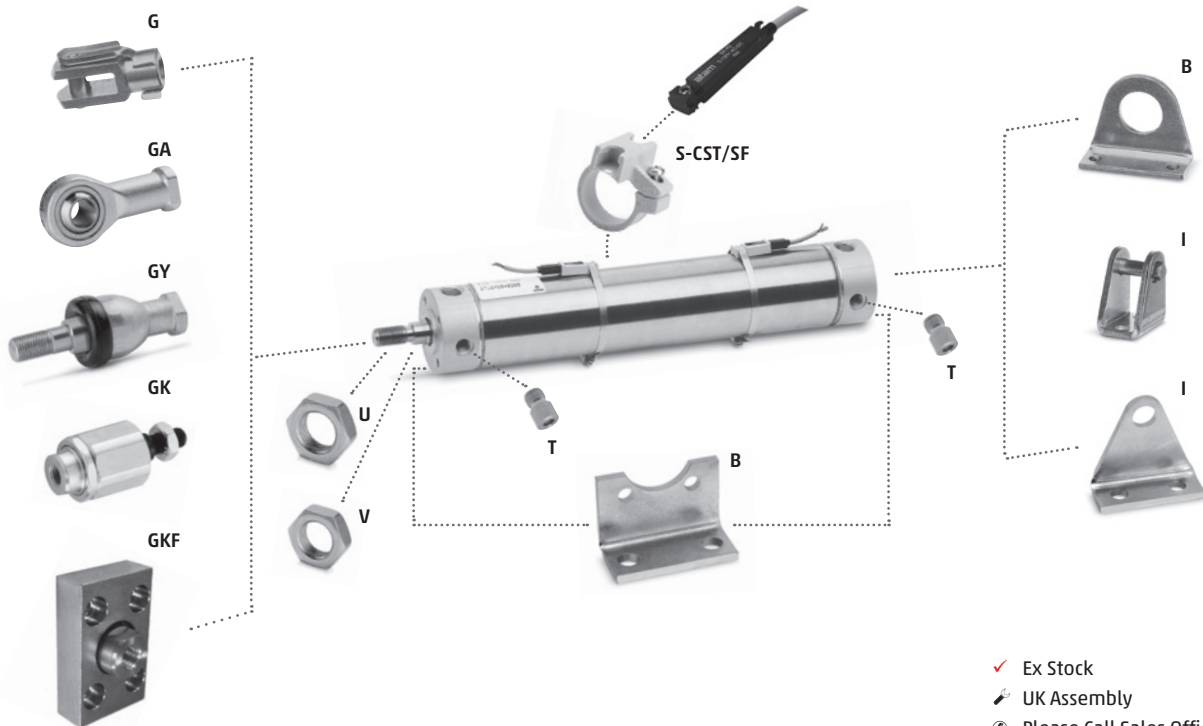

- ✓ Ex Stock
- ✂ UK Assembly
- ⊗ Please Call Sales Office

Foot Mounts (single)	B	Foot Mounts (pair)	B	Rear Trunnion Bracket	I	Rear Trunnion Bracket (pair)	I
∅		∅		∅		∅	
B-27-20	20 ✓	B-27-50	50 ✓	I-27-20	20 ✓	I-27-50	50 ✓
B-27-25	25 ✓	B-27-63	63 ✓	I-27-25	25 ✓	I-27-63	63 ✓
B-27-32	32 ✓			I-27-32	32 ✓		
B-27-40	40 ✓			I-27-40	40 ✓		
Rod Fork End	G	Swivel Ball Joint	GA	Piston Rod Socket Joint	GY	Self Aligning Rod	GK
∅		∅		∅		∅	
G-20	20 ✓	GA-20	20 ✓	GY-20	20 ✓	GK-20	16 ✓
G-25-32	25-32 ✓	GA-32	25-32 ✓	GY-32	25-32 ✓	GK-25-32	25-32 ✓
G-40	40-50 ✓	GA-40	40-50 ✓	GY-40	40-50 ✓	GK-40	40-50 ✓
G-50-63	63 ✓	GA-50-63	63 ✓	GY-50-63	63 ✓	GK-50-63	63 ✓
Coupling Piece	GKF	Piston Rod Lock Nut	U	Nose Nut	V	Threaded Trunnion Pin	T
∅		∅		∅		∅	
GKF-20	20 ✓	U-20	20 ✓	V-12-16	20 ✓	T-27-50	50 ✓
GKF-25-32	25-32 ✓	U-25-32	25-32 ✓	V-27-25	25 ✓	T-27-63	63 ✓
GKF-40	40-50 ✓	U-40	40-50 ✓	V-20-25	32 ✓		
GKF-50-63	63 ✓	U-50-63	63 ✓	V-42-32	40 ✓		

Series 42 Cylinders

Single-acting and double-acting, magnetic
 Ø 32, 40, 50, 63 mm cushioned



The Camozzi Series 42 cylinders have been designed without tie rods to assure an extremely clean design



Technical Data
Operating Pressure
 Min 1 bar to Max 10 bar (double acting)
 Min 2 bar to Max 10 bar (single acting)
Operating Temperature
 0°C to +80°C.
 (with dry air -20°C)
 Full Data Sheet and Dimensions at <https://store.camozzi.co.uk>

PNEUMATIC ACTUATION

Double-acting and Single-acting (through rod and non-standard strokes available on request)

ACCESSORIES

- ✓ Ex Stock
- ✎ UK Assembly
- ☎ Please Call Sales Office

REED SWITCH	SWITCH MOUNTING BRACKET	BANJO FLOW CONTROL	BANJO RING FITTING	STRAIGHT CONNECTION	ELBOW FITTING

Part Number	Availability	Bore	Port Size
Single-Acting. Magnetic			
42M1N032A*	✎	32	1/8
42M1N040A*	✎	40	1/4
42M1N050A*	✎	50	1/4
42M1N063A*	✎	63	3/8
Double-Acting. Magnetic			
42M2N032A*	✎	32	1/8
42M2N040A*	✎	40	1/4
42M2N050A*	✎	50	1/4
42M2N063A*	✎	63	3/8

SKR2C01200	S-CST-06	SCU 604-1/8	6610 4-1/8	S6510 4-1/8	S6520 4-1/8
SKR2C01200	S-CST-07	SCU 606-1/4	6610 6-1/4	S6510 6-1/4	S6520 6-1/4
SKR2C01200	S-CST-08	SCU 606-1/4	6610 6-1/4	S6510 6-1/4	S6520 6-1/4
SKR2C01200	S-CST-08	SCU 608-3/8	6610 8-3/8	S6510 8-3/8	S6520 8-3/8
SKR2C01200	S-CST-06	SCU 604-1/8	6610 4-1/8	S6510 4-1/8	S6520 4-1/8
SKR2C01200	S-CST-07	SCU 606-1/4	6610 6-1/4	S6510 6-1/4	S6520 6-1/4
SKR2C01200	S-CST-08	SCU 606-1/4	6610 6-1/4	S6510 6-1/4	S6520 6-1/4
SKR2C01200	S-CST-08	SCU 608-3/8	6610 8-3/8	S6510 8-3/8	S6520 8-3/8

*Insert stroke length to complete part number

STANDARD STROKES FOR CYLINDERS SERIES 42

- Double-acting
- * Single-acting

	ø32	ø40	ø50	ø63
Standard Stroke				
25	■ *	■ *	■ *	■ *
50	■ *	■ *	■ *	■ *
75	■ *	■ *	■ *	■ *
80	■	■	■	■
100	■	■	■	■
125	■	■	■	■
150	■	■	■	■
160	■	■	■	■
200	■	■	■	■
250	■	■	■	■
300	■	■	■	■
320	■	■	■	■
400	■	■	■	■
500	■	■	■	■

CODING EXAMPLE

42	M	2	N	050	A	0200	-
42	SERIES: 42			050	BORE: 32, 40, 50, 63mm		
M	VERSION: M = standard, magnetic			A	TYPE OF DESIGN A = standard (screw with ring V + lock nut for rod U)		
2	OPERATION: 1 = single-acting (front spring) 2 = double-acting (front and rear cushions) 3 = double-acting (no cushion) 4 = double-acting (rear cushions) 5 = double-acting (front cushion) 6 = double-acting (through-rod with front and rear cushions) 7 = single-acting (through-rod)			0200	STROKE: (see table)		
N	MATERIALS: N = Stainless steel AISI 420B rod - stainless steel AISI 304 tube - NBR seals			-	SPECIAL: to be specified		

42M2N = standard version available on stock.

Series 42 Accessories

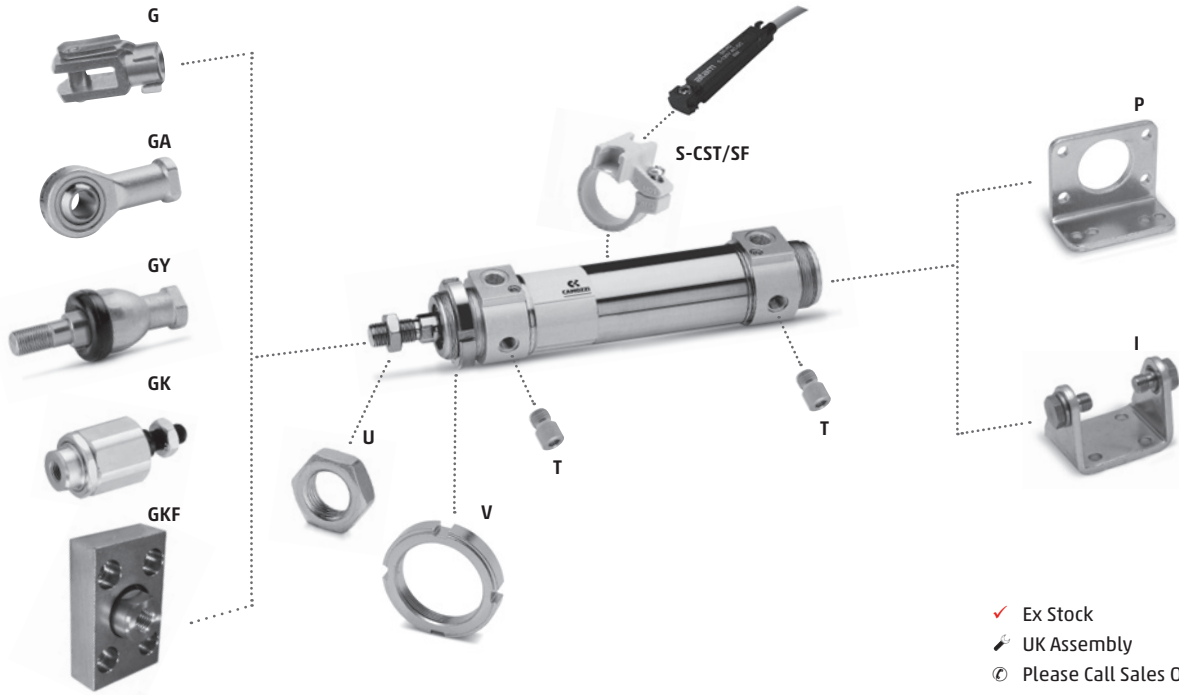

- ✓ Ex Stock
- 🔧 UK Assembly
- 📞 Please Call Sales Office

Foot Mounts (Pair)	P	Trunnion	I	Rod Fork End	G	Swivel Ball Joint	GA
∅		∅		∅		∅	
P-42-32	32 ✓	I-42-32	32 ✓	G-25-32	32 ✓	GA-32	32 ✓
P-42-40	40 ✓	I-42-40	40 ✓	G-40	40 ✓	GA-40	40 ✓
P-42-50	50 ✓	I-42-50	50 ✓	G-50-63	50-63 ✓	GA-50-63	50-63 ✓
P-42-63	63 ✓	I-42-63	63 ✓				
Piston Rod Socket Joint	GY	Self Aligning Rod	GK	Coupling Piece	GKF	Piston Rod Lock Nut	U
∅		∅		∅		∅	
GY-32	32 ✓	GK-25-32	32 ✓	GKF-25-32	32 ✓	U-25-32	32 ✓
GY-40	40 ✓	GK-40	40 ✓	GKF-40	40 ✓	U-40	40 ✓
GY-50-63	50-63 ✓	GK-50-63	50-63 ✓	GKF-50-63	50-63 ✓	U-50-63	50-63 ✓
Nose Nut	V	Threaded Trunnion Pin (Pair)	T				
∅		∅					
V-42-32	32 ✓	T-42-32	32 ✓				
V-42-40	40 ✓	T-42-40	40 ✓				
V-42-50-63	50-63 ✓	T-42-50	50 ✓				
		T-42-63	63 ✓				

Series 69 Rotary Cylinders

Double-acting, Magnetic
 Ø 32, 40, 50, 63, 80, 100, 125 mm

The Camozzi Series 69 Rotary Cylinders can be used in extreme conditions with optimum results, due to the design and materials used.



Technical Data
Operating Pressure
 1 bar to 10 bar
Operating Temperature
 0°C to +80°C.
 (with dry air -20°C)
 Full Data Sheet and Dimensions at
<https://store.camozzi.co.uk>

PNEUMATIC ACTUATION

- ✓ Ex Stock
- ✎ UK Assembly
- Ⓞ Please Call Sales Office

	REED SWITCH	SWITCH MOUNTING BRACKET	BANJO FLOW CONTROL	BANJO RING FITTING	STRAIGHT CONNECTION	ELBOW FITTING			
Part Number	Availability	Bore	Port Size						
Double-Acting, Magnetic									
69-032/*	Ⓞ	32	1/8	SKR2C01200	Direct Mount	SCU 604-1/8	6610 4-1/8	S6510 4-1/8	S6520 4-1/8
69-040/*	Ⓞ	40	1/4	SKR2C01200	Direct Mount	SCU 606-1/4	6610 6-1/4	S6510 6-1/4	S6520 6-1/4
69-050/*	Ⓞ	50	1/4	SKR2C01200	Direct Mount	SCU 606-1/4	6610 6-1/4	S6510 6-1/4	S6520 6-1/4
69-063/*	Ⓞ	63	3/8	SKR2C01200	Direct Mount	SCU 608-3/8	6610 8-3/8	S6510 8-3/8	S6520 8-3/8
69-080/*	Ⓞ	80	3/8	SKR2C01200	Direct Mount	SCU 608-3/8	6610 8-3/8	S6510 8-3/8	S6520 8-3/8
69-100/*	Ⓞ	100	1/2	SKR2C01200	Direct Mount	SCU 610-1/2	S6510 10-1/2	S6510 10-1/2	S6520 10-1/2
69-125/*	Ⓞ	125	1/2	SKR2C01200	Direct Mount	SCU 610-1/2	S6510 10-1/2	S6510 10-1/2	S6520 10-1/2

*Insert rotation angle to complete part number

TABLE SHOWING OUTPUT TORQUES IN Nm (THEORETICAL)

Bore	32	40	50	63	80	100	125
Torque moment (Nm)							
1 bar		1.2	2.25	3.9	7.3	15.7	26.35
2 bar		2.4	4.5	7.8	14.6	31.4	52.70
3 bar		3.6	6.75	11.7	21.9	47.1	79.05
4 bar		4.8	9.0	15.6	29.2	62.8	105.40
5 bar		6.0	11.25	19.5	36.5	78.5	131.75
6 bar		7.2	13.5	23.4	43.8	94.2	158.10
7 bar		8.4	15.75	27.3	51.1	109.9	184.45
8 bar		9.6	18.0	31.2	58.4	125.6	210.80
9 bar		10.8	20.25	35.1	65.7	141.3	237.15
10bar		12.0	22.5	39.0	73.0	157.0	263.50

See full catalogue or catalogue.camozzi.com for all dimensions.
 For technical advice contact our sales office or your local Camozzi distributor.

Applicable Loads

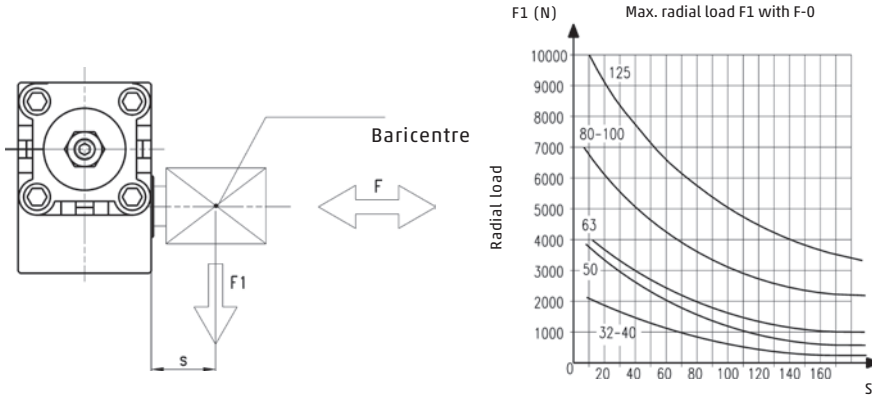

AXIAL LOAD F MAX WITH F1=0

∅Cyl.	32	40	50	63	80	100	125
F (N)	100	100	120	120	200	250	300

CODING EXAMPLE

69	-	050	/	090	-	F
69	SERIES: 69			090	ROTATIONAL ANGLES: 90°, 180°, 270°, 360°	
050	BORE: 32, 40, 50, 63, 80, 100, 125mm			F	PINION: F = Female M = Male	

Series 30 Rotary Cylinders

Standard rotation angles 90° and 180°
Cushioned and non-cushioned.
∅ 50, 63, 80, 100 mm

The Camozzi Series 30 Rotary Cylinders are constructed from profiled aluminium, their compact dimensions and clean lines give a good aesthetic appearance.



Technical Data

Operating Pressure
Min 0.5 bar to max 10 bar

Operating Temperature
0°C to +50°C.
(with dry air -20°C)

Full Data Sheet and Dimensions at
<https://store.camozzi.co.uk>

ACCESSORIES

- ✓ Ex Stock
- 🔧 UK Assembly
- 📞 Please Call Sales Office

BANJO FLOW CONTROL	BANJO RING FITTING	STRAIGHT CONNECTION	ELBOW FITTING
--------------------	--------------------	---------------------	---------------



Part Number	Availability	Bore	Port Size
-------------	--------------	------	-----------

30-050/*	🕒	50	1/8
69-063/*	🕒	63	1/8
69-080/*	🕒	80	1/4
69-100/*	🕒	100	3/8

SCU 604-1/8	6610 6-1/8	S6510 6-1/8	S6520 6-1/8
SCU 604-1/8	6610 6-1/8	S6510 6-1/8	S6520 6-1/8
SCU 606-1/4	6610 6-1/4	S6510 6-1/4	S6520 6-1/4
SCU 608-3/8	6610 8-3/8	S6510 8-3/8	S6520 8-3/8

*Insert rotational angle to complete part number

Series 50 Rodless Cylinders

Double-acting, Magnetic, Cushioned
 Ø 16, 25, 32, 40, 50, 63, 80 mm

SAME DAY
 CYLINDER SERVICE

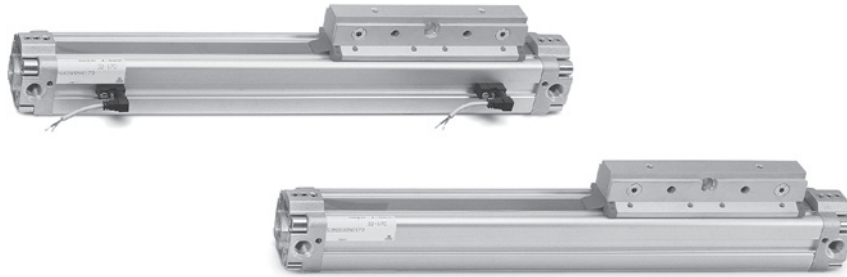

Technical Data
Operating Pressure
 Min 1 bar to max 8 bar
Operating Temperature
 0°C to +50°C.
 (with dry air -10°C)
 Full Data Sheet and Dimensions at
<https://store.camozzi.co.uk>

PNEUMATIC ACTUATION

ACCESSORIES

- ✓ Ex Stock
- ✎ UK Assembly
- ⊗ Please Call Sales Office

REED SWITCH	SWITCH MOUNTING BRACKET	BANJO FLOW CONTROL	BANJO RING FITTING	STRAIGHT CONNECTION	ELBOW FITTING
50M2P16A*	CSV-220 Direct Mount	SCU 602-M5	6610 4-M6	6512 4-M5	6522 4-M5
50M2P25A*	CSV-220 Direct Mount	SCU 604-1/8	6610 4-1/8	S6510 4-1/8	S6520 4-1/8
50M2P32A*	SKR2C1200 SZR12	SCU 606-1/4	6610 6-1/4	S6510 6-1/4	S6520 6-1/4
50M2P40A*	SKR2C1200 SZR12	SCU 606-1/4	6610 6-1/4	S6510 6-1/4	S6520 6-1/4
50M2P50A*	SKR2C1200 SZR12	SCU 606-1/4	6610 6-1/4	S6510 6-1/4	S6520 6-1/4
50M2P63A*	SKR2C1200 SZR12	SCU 608-3/8	6610 8-3/8	S6510 8-3/8	S6520 8-3/8
50M2P80A*	SKR2C1200 SZR12	SCU 610-1/2	6610 10-1/2	S6510 10-1/2	S6520 10-1/2

Part Number	Availability	Bore	Port Size
Magnetic			
50M2P16A*	✓	16	M5
50M2P25A*	✓	25	1/8
50M2P32A*	✓	32	1/4
50M2P40A*	✓	40	1/4
50M2P50A*	✓	50	1/4
50M2P63A*	✓	63	3/8
50M2P80A*	✓	80	1/2

*Insert stroke length to complete part number

CODING EXAMPLE

50	M	2	P	50	A	0500
50 SERIES: 50	M VERSION: M = magnetic standard	2 OPERATION: 2 = double-acting cushioned standard carriage	P MATERIALS: P = anodized AL profile tube - PU and NBR seals - standard carriage U = anodized AL profile tube - PU and NBR seals - flanged carriage	50 BORE: 16, 25, 32, 40, 50, 63, 80mm	A TYPE OF MOUNTING A = standard B = feet BH = intermediate feet CF = floating bracket	0500 STROKE: Min 100mm - Max 4000mm

Note: All accessories are supplied separately.

Series 50 Accessories

- ✓ Ex Stock
- ✎ UK Assembly
- ⊗ Please Call Sales Office

Foot Mounts (pair)		Intermediate Foot Mounts		Floating Bracket	
Ø		Ø		Ø	
B-50-16	16 ✓	BH-50-16	16 ✓	CF-50-25	25 ✓
B-50-25	25 ✓	BH-50-25	25 ✓	CF-50-32	32 ✓
B-50-32	32 ✓	BH-50-32	32 ✓	CF-50-40	40 ✓
B-50-40	40 ✓	BH-50-40	40 ✓	CF-50-50	50 ✓
B-50-50	50 ✓	BH-50-50	50 ✓	CF-50-63	63 ✓
B-50-63	63 ✓	BH-50-63	63 ✓	CF-50-80	80 ✓
B-50-80	80 ✓	BH-50-80	80 ✓		

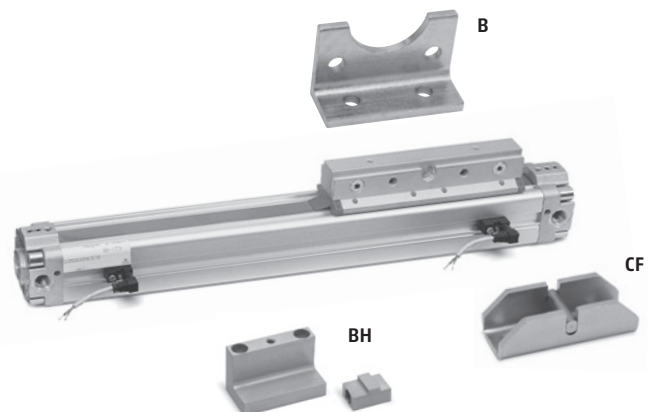

Maximum Permitted Loads and Torque Forces

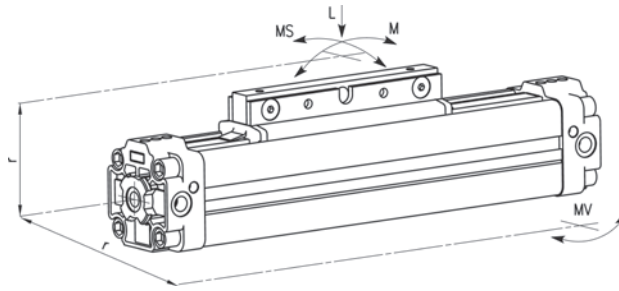

$M = F \times b$
 $M_s = F \times b$
 $M_v = F \times b$

$\varnothing_{cyl.}$	Max. load permitted (N) L	Max. bending torque force permitted (Nm) M	Max. bending torque force permitted (Nm) Ms	Torsional torque force permitted (Nm) Mv
16	218	3.1	0.5	1
25	660	12.4	1.9	5
32	720	30	4	8
40	1370	39	4	9
50	1600	122	11	16
63	2210	190	19	26
80	3770	305	30	47

Note: Loads and bending torque are valid if applied separately.

Loads According to Supports' Distance

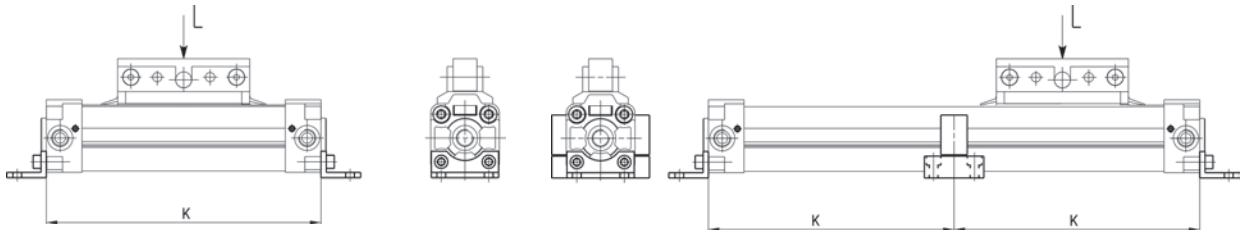

Note: The charts below have been made according to a max. distance of 0.5 mm/Load (N). Once the load and the cylinder diameter have been fixed, the charts reported below give the k values beyond which it is necessary to put an intermediate feet.

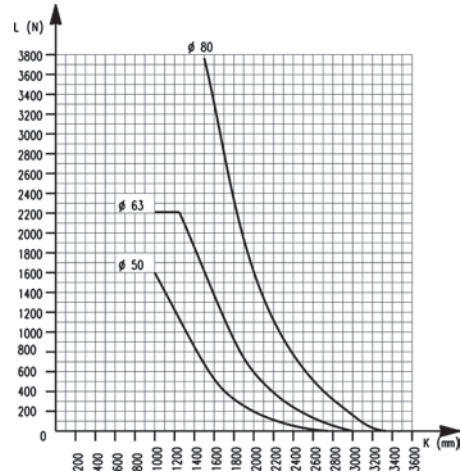
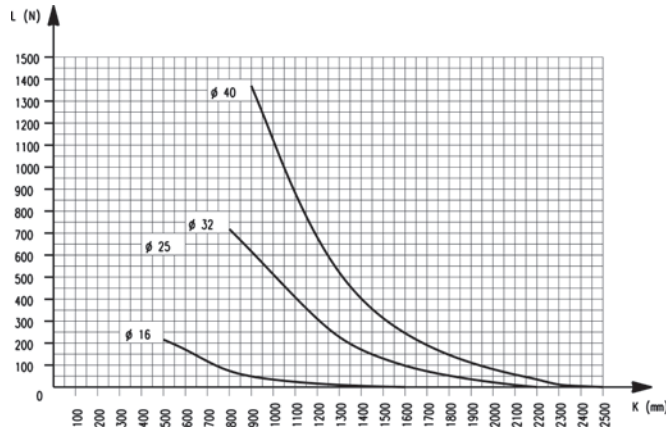

Series 52 Rodless Cylinders

Double-acting, Magnetic, cushioned
 Ø 25, 32, 40, 50, 63 mm

SAME DAY
 CYLINDER SERVICE

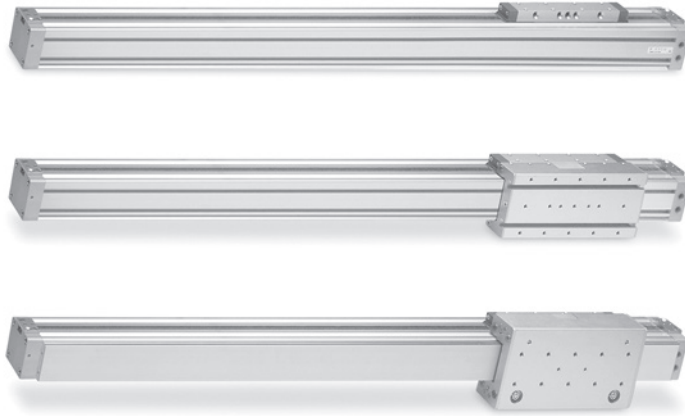

Technical Data
Operating Pressure
 Min 1 bar to max 8 bar
Operating Temperature
 -10°C to +70°C)
 Full Data Sheet and Dimensions at
<https://store.camozzi.co.uk>

PNEUMATIC ACTUATION

- ✓ Ex Stock
- 🔧 UK Assembly
- 📞 Please Call Sales Office

REED SWITCH	SWITCH MOUNTING BRACKET	BANJO FLOW CONTROL	BANJO RING FITTING	STRAIGHT CONNECTION	ELBOW FITTING
52M2P25A*	Direct Mount	SCU 604-1/8	6610 6-1/8	6512 6-1/8	6522 6-1/8
52M2P32A*	Direct Mount	SCU 604-1/8	6610 6-1/8	6512 6-1/8	6522 6-1/8
52M2P40A*	Direct Mount	SCU 606-1/4	6610 6-1/4	S6510 6-1/4	S6520 6-1/4
52M2P50A*	Direct Mount	SCU 608-3/8	6610 8-3/8	S6510 8-3/8	S6520 8-3/8
52M2P63A*	Direct Mount	SCU 608-3/8	6610 8-3/8	S6510 8-3/8	S6520 8-3/8

Part Number	Availability	Bore	Port Size
Magnetic			
52M2P25A*	🔧	25	1/8
52M2P32A*	🔧	32	1/8
52M2P40A*	🔧	40	1/4
52M2P50A*	🔧	50	3/8
52M2P63A*	🔧	63	3/8

*Insert stroke length to complete part number

CODING EXAMPLE

52	M	2	P	40	A	0500
-----------	----------	----------	----------	-----------	----------	-------------

52	SERIES: 52	40	BORE: 25, 32, 40, 50, 63mm
M	VERSION: M = standard G = with slide bearing R = with roller bearing (only Ø25 - 32 - 40)	A	TYPE OF MOUNTING: A = standard
2	OPERATION: 2 = double-acting, cushioned 8 = double-acting, cushioned, with air supply from one side only	0500	STROKE: Up to 6000mm
P	MATERIALS: P = anodised AL profile tube, NBR and Polyurethane seals, standard carriage C = anodised AL profile, NBR and Polyurethane seals, short carriage		

Note: All accessories are supplied separately.

Series 52 Accessories

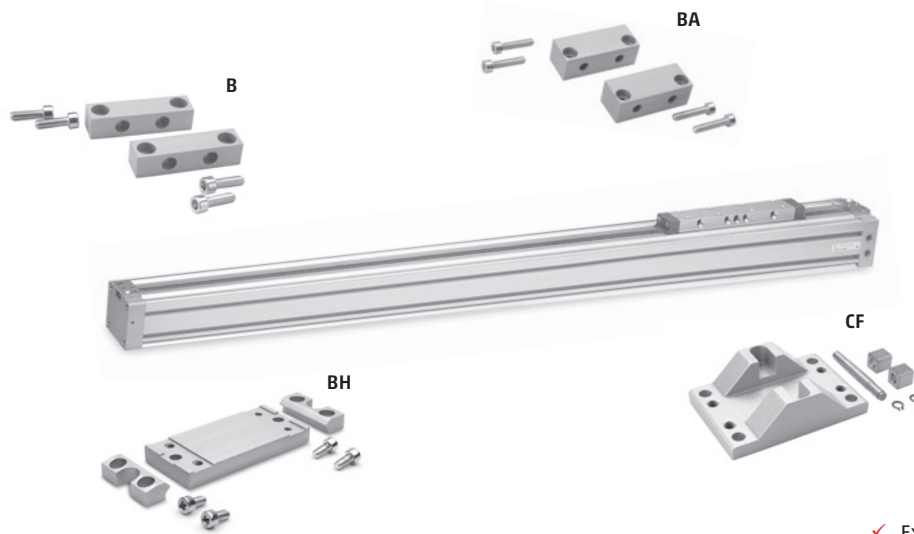

- ✓ Ex Stock
- 🔧 UK Assembly
- 📞 Please Call Sales Office

Foot Mounts			Foot Mounts for use for with BH			Intermediate Bracket			Self-compensating Adaptor		
	∅			∅			∅			∅	
B-52-25	25	📞	BA-52-25	25	📞	BH-52-25	25	📞	CF-52-25-32	25	📞
B-52-32	32	📞	BA-52-32	32	📞	BH-52-32	32	📞	CF-52-25-32	32	📞
B-52-40	40	📞	BA-52-40	40	📞	BH-52-40	40	📞	CF-52-40	40	📞
B-52-50	50	📞	BA-52-50	50	📞	BH-52-50	50	📞	CF-52-50-63	50	📞
B-52-63	63	📞	BA-52-63	63	📞	BH-52-63	63	📞	CF-52-50-60	63	📞

Use with Intermediate

Loads and Torque Forces ∅25, ∅32 mm

COMPLEX LOADS

If more than one force and torque is applied simultaneously, they have to be calculated according to the following formula:
 $L/L(\max) + Ls/Ls(\max) + M/M(\max) + Ms/Ms(\max) + Mv/Mv(\max) \leq 1$.

For models 52M, the load and torque values refer to the center of the tube. For models 52G/52R the load and torque values refer to the centre point of the external guide. It is also necessary for these models to guarantee on the fixing surface a max 0.1 flatness's value.

The load and torque values refer to a velocity of:
 Models 52M/52G/52M/52G ≤ 0.2 m/s, models 52R ≤ 2 m/s.

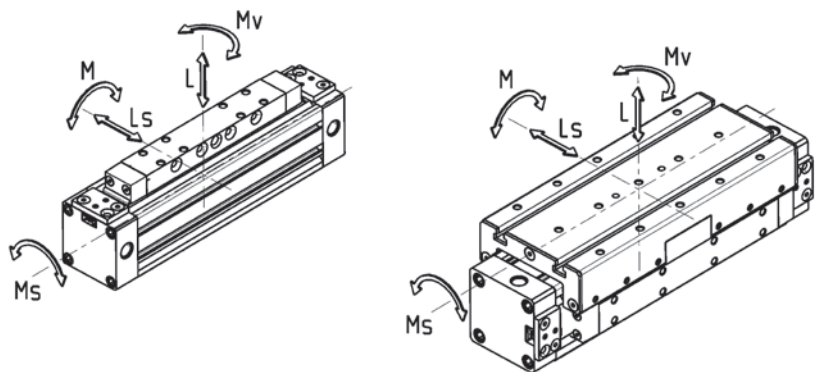

Table showing the maximum permitted loads and torque forces

Part Number	L Max (N)	Ls Max (N)	M Max (Nm)	Ms Max (Nm)	Mv Max (Nm)	Mass at 0 mm stroke (kg)	Additional mass per 100 mm (kg)
52M2P25A - 52M8P25A	270	-	13	2.5	11	0.88	0.30
52M2C25A - 52M8C25A	270	-	8	2	7	0.62	0.30
52G2P25A - 52G8P25A	580	580	23	10	23	1.31	0.30
52G2C25A - 52G8C25A	340	340	9	5	9	0.88	0.30
52R2P25A - 52R8P25A	850	1300	65	35	105	1.97	0.42
52R2C25A - 52R8C25A	850	1300	29	35	64	1.33	0.42
52M2P32A - 52M8P32A	300	-	30	3	24	1.40	0.39
52M2C32A - 52M8C32A	300	-	15	3	12	0.96	0.39
52G2P32A - 52G8P32A	850	850	33	15	33	2.09	0.39
52G2C32A - 52G8C32A	460	460	14	6.5	14	1.35	0.39
52R2P32A - 52R8P32A	900	1500	79	40	125	2.96	0.48
52R2C32A - 52R8C32A	900	1500	36	40	76	1.91	0.48

Loads and Torque Forces Ø40, Ø50, Ø63 mm

COMPLEX LOADS

If more than one force and torque is applied simultaneously, they have to be calculated according to the following formula:

$$L/L(\max) + L_s/L_s(\max) + M/M(\max) + M_s/M_s(\max) + M_v/M_v(\max) \leq 1.$$

For models 52M, the load and torque values refer to the centre of the tube. For models 52G/52R the load and torque values refer to the center point of the guide.

The load and torque values refer to a velocity of: Models 52M/52G ≤ 0.2 m/s Models 52R ≤ 2 m/s If the velocity exceeds 0.2m/s for the models 52M/52G, the load and torque values have to be multiplied by the coefficients according to the table.

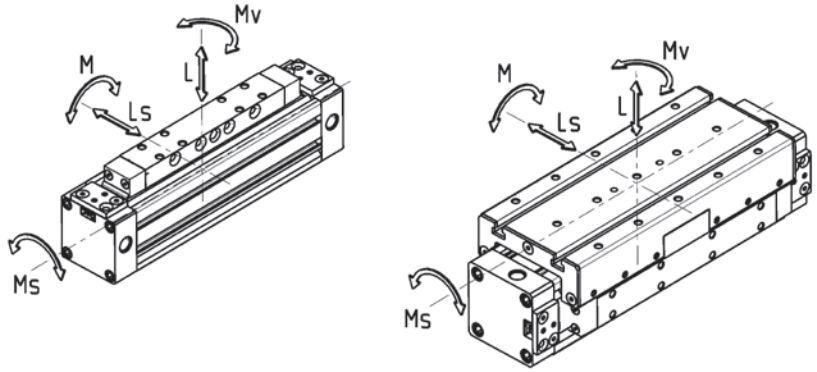
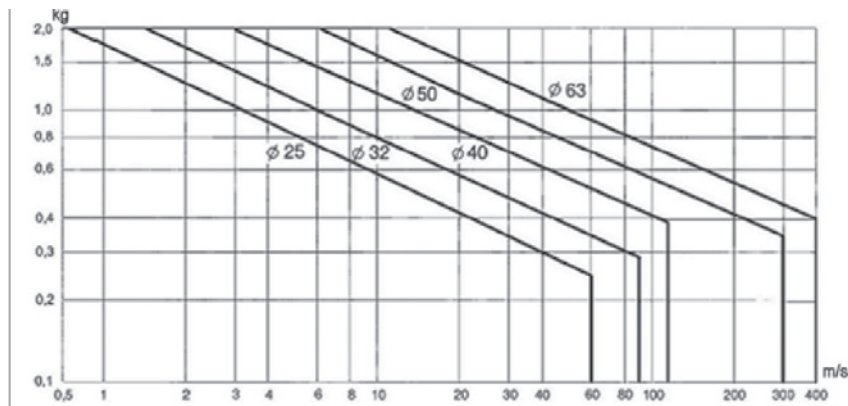

Table showing the maximum permitted loads and torque forces

Part Number	L Max (N)	Ls Max (N)	M Max (Nm)	Ms Max (Nm)	Mv Max (Nm)	Mass at 0 mm stroke (kg)	Additional mass per 100 mm (kg)
52M2P40A - 52M8P40A	650	-	60	4	54	2.41	0.52
52M2C40A - 52M8C40A	650	-	30	4	27	1.65	0.52
52G2P40A - 52G8P40A	1120	1120	60	25	60	3.58	0.52
52G2C40A - 52G8C40A	600	600	25	11	25	2.30	0.52
52R2P40A - 52R8P40A	1200	2000	190	67	118	5.89	0.74
52R2C40A - 52R8C40A	1200	2000	85	67	72	3.84	0.74
52M2P50A - 52M8P50A	800	-	80	17	74	5.30	0.96
52M2C50A - 52M8C50A	800	-	38	17	32	3.50	0.96
52G2P50A - 52G8P50A	1550	1500	200	70	200	7.28	0.96
52G2C50A - 52G8C50A	820	800	60	40	60	4.63	0.96
52M2P63A - 52M8P63A	1400	-	110	17	100	8.10	1.32
52M2C63A - 52M8C63A	1400	-	50	17	48	5.40	1.32
52G2P63A - 52G8P63A	2200	2000	300	102	300	11.02	1.32
52G2C63A - 52G8C63A	1100	1100	105	56	105	7.10	1.32

End Cushion Diagram



The end cushion regulating screw has to be regulated to obtain a smooth movement at the end of stroke.
 In those applications which have different values than the ones stated in the diagram, external shock-absorbers have to be used. The shock-absorber should be centrally located with respect to the centre of the mass.
 The diagram applies for horizontal operations.

Correction coefficient, loads speed - coefficient:

- 0.2 m/s - 1
- 0.3 m/s - 0.75
- 0.4 m/s - 0.5
- 0.5 m/s - 0.4
- 0.75 m/s - 0.27
- 1 m/s - 0.2

Loads According to Supports Distance

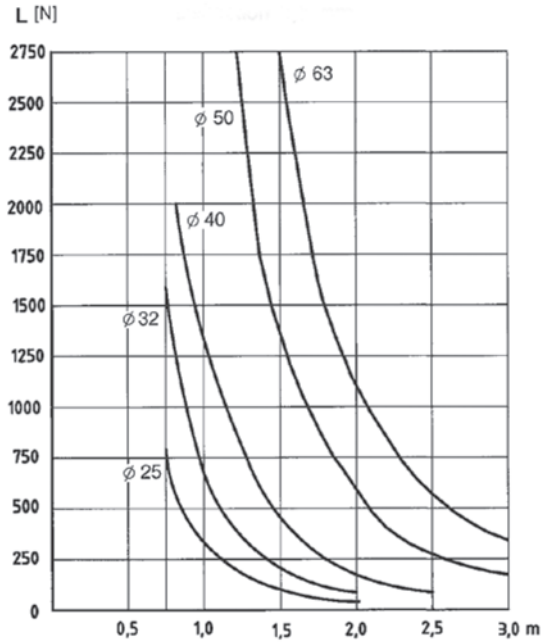

DEFLECTION 0.5 mm
The charts have been made according to a max. deflection of 0.5 mm and 1 mm when a load (N) is applied. The charts give the max distance between two supports in order to stay within the deflection range given.

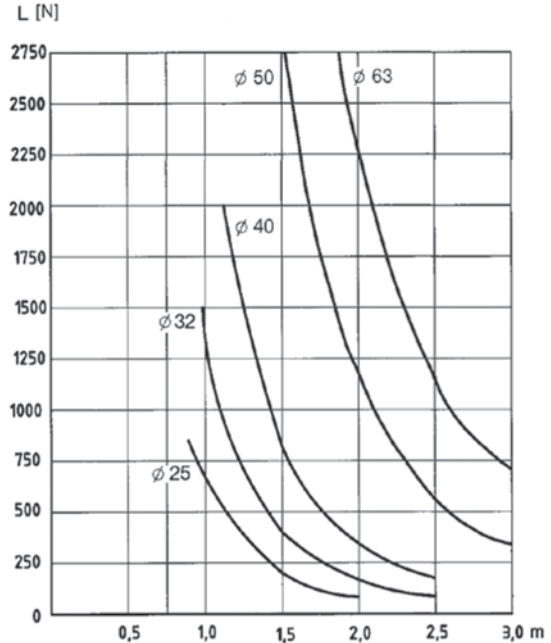

DEFLECTION 1 mm
The charts have been made according to a max. deflection of 0.5 mm and 1 mm when a load (N) is applied. The charts give the max distance between two supports in order to stay within the deflection range given.

Magnetic Proximity Switches

For use with Camozzi cylinders, in conjunction with the appropriate bracket shown on the opposite page.

With 2/3 Wire Cable



- ✓ Ex Stock
- 🇬🇧 UK Assembly
- ☎ Please Call Sales Office

Part Number	Availability	Description	Cable Length	For use with
SKR2C01200	✓	T slot reed, 2 wires, 5 - 130v AC/DC	2m	All cylinders, see brackets (pg 46)
CSV-220	✓	V slot reed, 2 wires, 10 - 110v AC/DC	2m	All cylinders, see brackets (pg 46)
SKR3C01300	✓	T slot reed, 3 wires, 5 - 30v AC/DC	3m	All cylinders, see brackets (pg 46)
CSV-232	✓	V slot reed, 3 wires, 5 - 30v AC/DC	2m	All cylinders, see brackets (pg 46)
SKH3C01200	✓	T slot hall effect, 3 wires, PNP, 10 - 30v DC	2m	All cylinders, see brackets (pg 46)
CSV-332	✓	V slot hall effect, 3 wires, PNP, 10 - 27v DC	2m	All cylinders, see brackets (pg 46)
SKR6C01300	✓	T slot reed, 2 wires, 5 - 230v AC/DC	3m	All cylinders, see brackets (pg 46)
CSH-223-2	✓	Reed, 2 wires, 10 - 30v AC/DC	2m	Series 63 Profile
CSH-223-5	✓	Reed, 2 wires, 10 - 30v AC/DC	5m	Series 63 Profile

For the correct function of Proximity Switches they must only be used with the relevant bracket where applicable. Please see below regarding the bracket to be used for each cylinder sensor/bore.

With Male Connector M8



- ✓ Ex Stock
- ✎ UK Assembly
- ☎ Please Call Sales Office

Part Number	Availability	Description
SKR2C01M8	✓	T slot reed, 2 wires with M8 connector, 5 - 50v AC/DC
CSV-250N	✓	V slot reed, 2 wires with M8 connector, 10 - 110v AC/DC
SKR3C01M8	✓	T slot reed, 3 wires with M8 connector, 5 - 30v AC/DC
CSV-262	✓	V slot reed, 3 wires with M8 connector, 5 - 30v AC/DC
SKH3C01M8	✓	T slot hall effect, 3 wires with M8 connector, PNP, 10 - 30v DC
CSV-362	✓	V slot hall effect, 3 wires with M8 connector, PNP, 10 - 30v DC
AG08B3C25500	✓	M8 female, 3 pole, 5m extension lead

Note: 2 & 3 wire reed switches listed are N.O. with a 2 metre long cable. Alternatives can be quoted on request. Reed switches fitted with an M8 connector are N.O. with a 0.3 metres long cable.

For the correct function of Proximity Switches they must only be used with the relevant bracket where applicable.

Please see below regarding the bracket to be used for each cylinder sensor/bore.

Magnetic Proximity Brackets

- ✓ Ex Stock
- ✎ UK Assembly
- ☎ Please Call Sales Office



For Series 23, 24, 25, 94 & 95

Part Number	Availability	Bore
SF16	✓	16
SF20	✓	20
SF25	✓	25

Bracket for use with T slot type switch



For Series 27

Part Number	Availability	Bore
SF20	✓	20
SF25	✓	25
S-CST 06	✓	32
S-CST 07	✓	40
S-CST 08	✓	50
S-CST 09	✓	63

Bracket for use with T slot type switch



For Series 42 and 97

Part Number	Availability	Bore
S-CST 06	✓	32
S-CST 07	✓	40
S-CST 08	✓	50
S-CST 09	✓	63

Bracket for use with T slot type switch



For Series 50

Part Number	Availability	Bore
Direct Mounting*	✓	16-25
SZR12**	✓	32-80

*with CSV type switch
**with T slot type switch

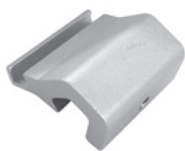

For Series 63 MT & 90

Part Number	Availability	Bore
SCD32	✓	32-63
SCD80	✓	80-100
S-CST-27	✓	125

For Series 40

S-CST-28	✓	160-200
----------	---	---------

Bracket for use with T slot type switch



For Series 45N

Part Number	Availability	Bore
S-CST 45N1	✓	32-63
S-CST 45N2	✓	80-100

Bracket for use with T slot type switch



For Series QP

Part Number	Availability	Bore
Direct Mounting*	✓	12-16
SZR12**	✓	20-100

For Series QPR

Direct Mounting*	✓	12-16
SZR12**	✓	20-100

*with CSV type switch
**with T slot type switch



Direct Mounting to cylinder tube

Series	Availability	Bore
31	✓	12-100
32	✓	20-100
52	✓	25-63
61	✓	32-125
63 (MP)	✓	32-125
69	✓	32-125

Direct mounting with T slot type switch, no bracket required

Series CSB - CSC Magnetic Proximity Switches

Reed Switch

The Camozzi Series CSB - CSC Magnetic Proximity Switch define the position of the magnetic piston. When the internal contact is actuated by a magnetic field, the sensors complete an electrical circuit and provide an output signal to actuate directly a solenoid valve or a PLC.

- ✓ Ex Stock
- ✎ UK Assembly
- ☎ Please Call Sales Office



Technical Data

Operating Temperature
-10°C to +60°C

Materials

Body: Plastic encapsulating epoxy resin

Mountings

Directly into the grooves

Special Requests

For assistance, contact our technical office or your local Camozzi distributor.

Part Number	Availability
CSB-D-220	☎
CSB-H-220	☎
CSC-D-220	☎
CSC-H-220	☎

*CSB type suit CGA, CGB, CGC and CGP type grippers.
**CSC type suit CGLN, CGSN and QX type grippers.

CODING EXAMPLE

CS	B	-	D	2	2	0
CS	SERIES: CS = Magnetic		2	2 = reed		
B	B = Square shape C = Round shape		20	2 = 2 wires (only reed)		
D	D = straight lead H = lead 90°					

PNEUMATIC ACTUATION

Electric Actuation

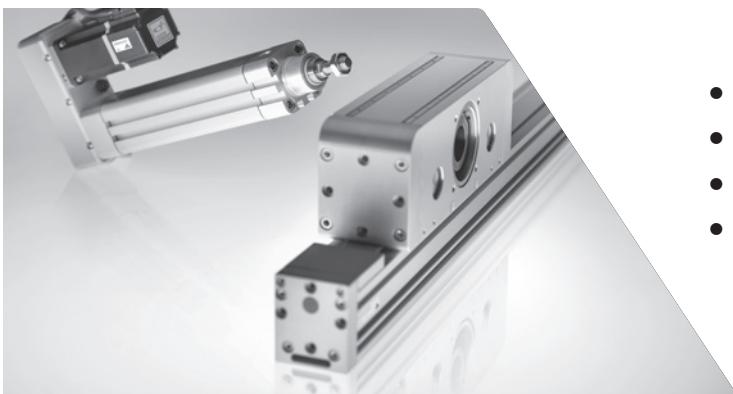

- Electromechanical cylinders
- Electromechanical Axes
- Drives
- Motors

Series 43 Hydrochecks

Skip - Stop Function

Ø 40 mm

The Camozzi series 43 comes complete with an oil surge tank which ensures automatic equalisation. Speed variation is obtained by means of an incorporated flow regulator designed to allow comprehensive and constant use.

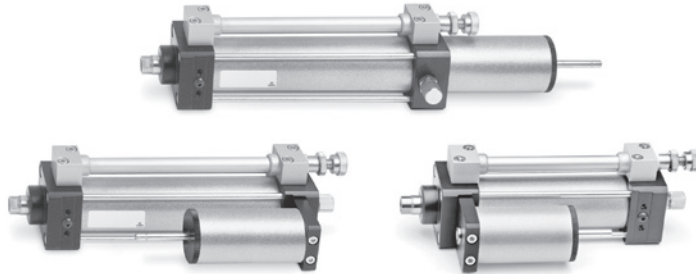

Technical Data

Type of Construction
With tie-rods

Media
Special hydraulic oil (contact our engineers)

Operating Pressure
Min 1 max 10 bar

Operating Temperature
-10°C to +60°C

Bore Size
40mm

Stroke Lengths
Standard - see tables
Non-standard - on request

Speed
Min 14mm/min
Max 15mm/min
(in non regulated direction)

Controllable Load
Max 500kg
(Including inertia of moving masses)

Special Requests
For assistance, contact our technical office or your local Camozzi distributor

Note
Controllable load 500kg max
(including inertia of moving).

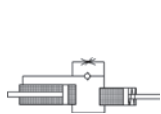

Part Number	Availability
43N-LTO-40-50	Ⓢ
43N-LTO-40-100	Ⓢ
43N-LTO-40-150	Ⓢ
43N-LTO-40-200	Ⓢ

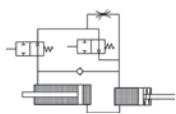

Part Number	Availability
43N-LTB-40-50	Ⓢ
43N-LTB-40-100	Ⓢ
43N-LTB-40-150	Ⓢ
43N-LTB-40-200	Ⓢ

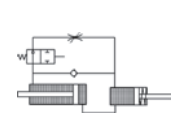

Part Number	Availability
43N-PTV-40-50	Ⓢ
43N-PTV-40-100	Ⓢ
43N-PTV-40-150	Ⓢ
43N-PTV-40-200	Ⓢ

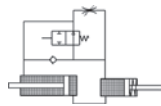

Part Number	Availability
43N-PSA-40-50	Ⓢ
43N-PSA-40-100	Ⓢ
43N-PSA-40-150	Ⓢ
43N-PSA-40-200	Ⓢ

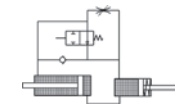

Part Number	Availability
43N-LTA-40-50	Ⓢ
43N-LTA-40-100	Ⓢ
43N-LTA-40-150	Ⓢ
43N-LTA-40-200	Ⓢ

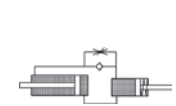

Part Number	Availability
43N-PTO-40-50	Ⓢ
43N-PTO-40-100	Ⓢ
43N-PTO-40-150	Ⓢ
43N-PTO-40-200	Ⓢ

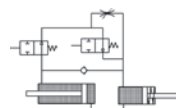

Part Number	Availability
43N-PTB-40-50	Ⓢ
43N-PTB-40-100	Ⓢ
43N-PTB-40-150	Ⓢ
43N-PTB-40-200	Ⓢ

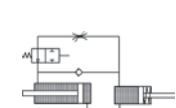

Part Number	Availability
43N-PSV-40-50	Ⓢ
43N-PSV-40-100	Ⓢ
43N-PSV-40-150	Ⓢ
43N-PSV-40-200	Ⓢ

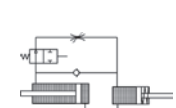

Part Number	Availability
43N-LTV-40-50	Ⓢ
43N-LTV-40-100	Ⓢ
43N-LTV-40-150	Ⓢ
43N-LTV-40-200	Ⓢ

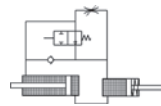

Part Number	Availability
43N-PTA-40-50	Ⓢ
43N-PTA-40-100	Ⓢ
43N-PTA-40-150	Ⓢ
43N-PTA-40-200	Ⓢ

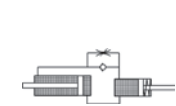

Part Number	Availability
43N-PSO-40-50	Ⓢ
43N-PSO-40-100	Ⓢ
43N-PSO-40-150	Ⓢ
43N-PSO-40-200	Ⓢ

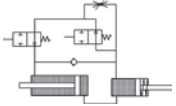

Part Number	Availability
43N-PSB-40-50	Ⓢ
43N-PSB-40-100	Ⓢ
43N-PSB-40-150	Ⓢ
43N-PSB-40-200	Ⓢ

Series 43 Accessories



Pump for Refilling
Hydraulic Speed
regulator

Hydrocheck Refilling Pump	Availability
43N-PMP	Ⓢ

CODING EXAMPLE

43	N	-	P	S	O	-	40	-	200
43 SERIES: 43									
N N = standard S = special			S S = thrust (rod return regulated) T = traction (rod thrust regulated)			40 BORE: 40mm			
P L = tank in series P = tank parallel			O A = SKIP valve B = SKIP + STOP valve V = STOP valve 0 = standard			200 STROKE in mm			

Part Number 43N-PNP. Pump for refilling hydrocheck speed regulator

PNEUMATIC ACTUATION

Accessories for Hydrochecks Series 43 - Connecting Kit

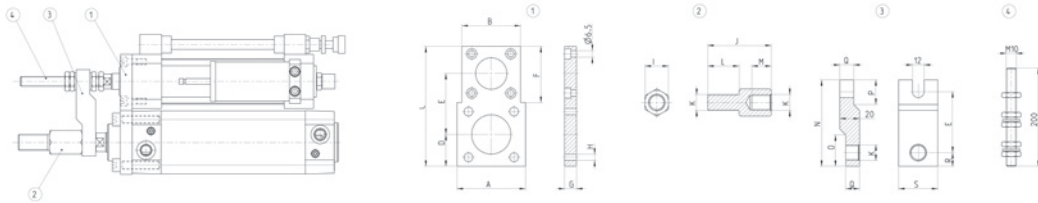

- ✓ Ex Stock
- ✂ UK Assembly
- 📞 Please Call Sales Office

Part Number	Availability	A	B	C	D	E	F	G	H	I	J	K	L	M	N	O	P	Q	R	S
43N-40-40	📞	60	-	110	26.5	56	-	12	7	19	47	M12 x 1.25	24	14	80	25	25	14	12	40
43N-40-50	📞	70	60	122	32.52	62	57	12	9	24	65	M16 x 1.5	32	20	88	32	25	14	14	40
43N-40-63	📞	80	60	132	37.5	67	57	20	9	24	65	M16 x 1.5	32	20	93	32	25	14	14	40
43N-40-80	📞	100	60	152	47.5	77	57	20	11	30	78	M20 x 1.5	40	25	107	-	-	-	18	50

Series 61 and 63 Valve Mounting Bracket

Example of assembly Series 61



Part Number	Availability	Mounting Bracket
PCV-61-K3	📞	for mounting solenoid valves Series 3, 1/8
PCV-61-K4	📞	for mounting solenoid valves Series 4, 1/4
PCV-61-K8	📞	for mounting solenoid valves Series 4, 1/8
PCV-62-KEN	📞	for mounting solenoid valves Series EN

Note: Fittings and valve supplied separately

Example of assembly Series 63



Part Number	Availability	Mounting Bracket
PCV-62-K3	📞	for mounting valves series 3
PCV-62-K4	📞	for mounting valves series 4, 1/4
PCV-62-KEN	📞	for mounting valves series EN
PCV-62-K8	📞	for mounting valves series 4, 1/8 and series 3, 1/4

Note: Fittings and valve supplied separately

Series RL Rod Locks

Ø 20, 25, 32, 40, 50, 63, 80, 100, 125 mm

For ISO 6431/VDMA and ISO 6432 cylinders

The Camozzi Series RL are of compact dimensions allowing units to be fitted on cylinders where space is limited.



Technical Data

Type of Construction
Compact

Operating Pressure
Min 3 max 8 bar

Operating Temperature
0°C to +80°C.
(with dry air -20°C)

Materials

Housing: anodised aluminium
Clamp: Brass
Seals: NBR

Cylinder diameter
Ø20, Ø32, Ø40, Ø50, Ø63, Ø80, Ø100, Ø125

Connections

Ø20, Ø25, Ø32 - M5
Ø40, Ø50, Ø63, Ø80, Ø100, Ø125 - 1/8

Special Requests

For assistance, contact our technical office or your local Camozzi distributor

Note

Cylinders must be ordered with a piston rod extension in order to fit rod locks. See table

Caution!

The rod lock should not be used to "brake" the piston rod in dynamic conditions and must only be applied when movement has ceased.

Standard, complete with cartridge and housing	Availability
RLC-24-20	Ⓞ
RLC-24-25	Ⓞ
RLC-41-32	Ⓞ
RLC-41-40	Ⓞ
RLC-41-50	Ⓞ
RLC-41-63	Ⓞ
RLC-41-80	Ⓞ
RLC-41-100	Ⓞ
RLC-41-125	Ⓞ

Cartridge only	Availability
RLB-24-20	Ⓞ
RLB-24-25	Ⓞ
RLB-41-32	Ⓞ
RLB-41-40	Ⓞ
RLB-41-50	Ⓞ
RLB-41-63	Ⓞ
RLB-41-80	Ⓞ
RLB-41-100	Ⓞ
RLB-41-125	Ⓞ

HOLDING FORCE (STATIC LOAD)

Ø	20	25	32	40	50	63	80	100	125
holding force N.	300	400	650	1100	1600	2500	4000	6300	8800

PISTON ROD EXTENSION

Ø	20	25	32	40	50	63	80	100	125
extension	+50	+48	+40	+43	+57	+57	+80	+80	+125

Scheme of Operation

Pneumatic control

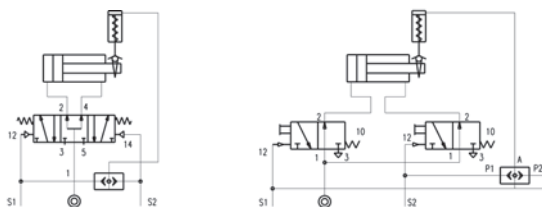

Electropneumatic control

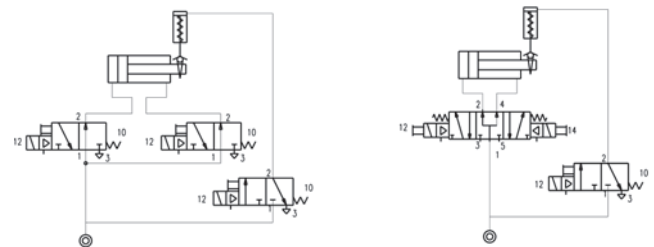

CODING EXAMPLE

RLC	-	41	-	32	
RLC	SERIES RLC = standard, complete with cartridge and housing RLB = cartridge only	41	CYLINDER SERIES 24 = for Series 24 and 25 41 = for Series 60 and 61, 63	32	CYLINDER BORE 20, 25, 32, 40, 50, 63, 80, 100, 125mm

Series SA Shock Absorbers

Self compensating

M8x1, M10x1, M12x1, M14x1.5, M20x1.5, M25x1.5, M27x1.5

The Camozzi Series SA Shock Absorbers are used to provide impact and noise absorption when stopping objects in motion.

PNEUMATIC ACTUATION

Part Number	Availability	Size	Stroke
SA-0806 W	☉	M8x1	6mm
SA-0806	☉	M8x1	6mm
SA-1007 W	☉	M10x1	7mm
SA-1007	☉	M10x1	7mm
SA-1210 W	☉	M12x1	10mm
SA-1210	☉	M12x1	10mm
SA-1412 W	☉	M14x1.5	12mm
SA-1412	☉	M14x1.5	12mm
SA-2015 W	☉	M20x1.5	15mm
SA-2015	☉	M20x1.5	15mm
SA-2525 W	☉	M25x1.5	25mm
SA-2525	☉	M25x1.5	25mm
SA-2725 W	☉	M27x1.5	25mm
SA-2725	☉	M27x1.5	25mm



Technical Data

Type of Construction
Hydraulic shock absorber, self compensating

Operating Temperature
-10°C to +80°C

Materials

Body: Steel, black coated
Piston Rod: Carbon steel, chrome plated
Piston: Carbon steel
Seals: NBR

Stroke Lengths

See Shock absorbers coding SA

Mountings

Threaded Body

Special Requests

For assistance, contact our technical office or your local Camozzi distributor.

CODING EXAMPLE

SA	0806
<p>SA SERIES: SA</p>	<p>0806 SIZE/STROKE</p> <p>0806 = size M8x1 stroke 6 mm</p> <p>1007 = size M10x1 stroke 7 mm</p> <p>1210 = size M12x1 stroke 10 mm</p> <p>1412 = size M14x1,5 stroke 12 mm</p> <p>2015 = size M20x1,5 stroke 15 mm</p> <p>2525 = size M25x1,5 stroke 25 mm</p> <p>2725 = size M27x1,5 stroke 25 mm</p>
	<p>OPTION</p> <p>None = Standard, with cap</p> <p>W = Without cap*</p> <p>* on request</p>

NOTE: The shock absorbers are supplied complete with 2 mounting nuts.

ADJUSTED STROKE NUT

- A = Initial position
- B = Final position
- 1 = Impact object
- 2 = Adjusted stroke nut
- 3 = Shock absorber
- 4 = Fixing screw
- 5 = Stroke
- 6 = Stroke length

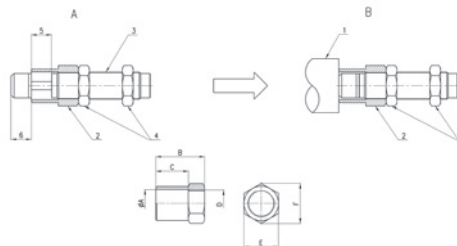

Mod.	ØA	B	C	D	E	F
SA-08SC (for SA-0806)	10.5	14	9	M8X1	11	12.7
SA-10SC (for SA-1007)	12	16	10	M10X1	13	14.7
SA-12SC (for SA-1210)	14.5	20	13	M12X1	16	18.5
SA-14SC (for SA-1412)	25.8	20	15	M14X1	19	21.9
SA-20SC (for SA-2015)	27.8	35	20	M20X1.5	26	30
SA-25SC (for SA-2525)	5.8	45	30	M25X1.5	32	37
SA-27SC (for SA-2725)	20.7	65	50	M27X1.5	32	37

Electric Actuation

1 Electromechanical Cylinders

	Page
 Series 6E Electromechanical Cylinders	53

2 Electromechanical Axes

	Page
 Series 5E Electromechanical Axis	56

 Series 5V Vertical electromechanical Axis	58
---	----

3 Drives

	Page
 Series DRWB Drives for the Control of Electric Actuation	60

 Series DRCS Drives for Stepper Motors	60
---	----

4 Motors

	Page
 Series MTB Motors for Electric Actuation	61

 Series MTS Motors for Electric Actuation	61
--	----

 Series GB Planetary Gearboxes	62
---	----

 Series CO Motion Transmission Devices	62
---	----

Series 6E Electromechanical Cylinders

Sizes 32, 40, 50, 63, 80, 100
ISO 1552 Standard

Technical Data

For full technical data please visit
<https://store.camozzi.co.uk>

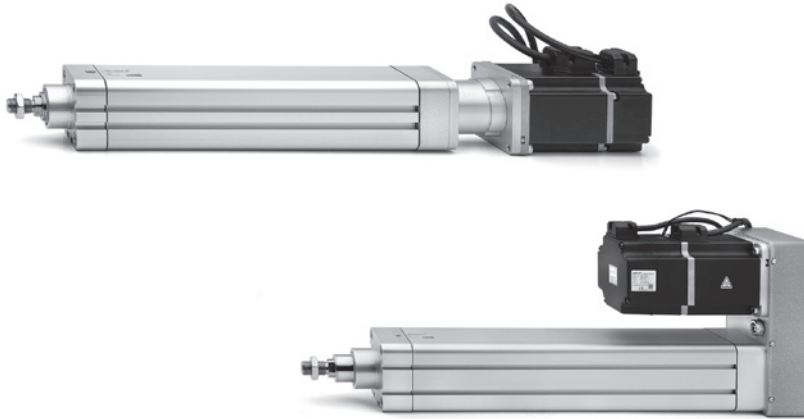

ELECTRIC ACTUATION

ACCESSORIES

- ✓ Ex Stock
- ✦ UK Assembly
- ⊗ Please Call Sales Office

Reed Switch	Switch Mounting Bracket
-------------	-------------------------



Part Number	Availability	Bore
Recirculating Ball Screw		
6E032BS*	✓	32
6E040BS*	✓	40
6E050BS*	✓	50
6E063BS*	✓	63
6E080BS*	✓	80
6E0100BS*	✓	100

SKR2C01200	Direct Mount
SKR2C01200	Direct Mount
SKR2C01200	Direct Mount
SKR2C01200	Direct Mount
SKR2C01200	Direct Mount
SKR2C01200	Direct Mount

*Insert stroke length to complete part number

STANDARD STROKES

STANDARD STROKES											
Size	100	200	300	400	500	600	700	800	1000	1200	1500
32	*	*	*	*	*						
40	*	*	*	*	*	*	*				
50	*	*	*	*	*	*	*	*	*		*
63	*	*	*	*	*			*	*	*	*

CODING EXAMPLE

6E	032	BS	0200	P05	A
-----------	------------	-----------	-------------	------------	----------

6E SERIES: 6E					
32 SIZE: 032 = 32 063 = 63 040 = 40 080 = 80 050 = 50 100 = 100		0200 STROKE: 100 TO 1500mm		A CONSTRUCTION: A = Standard with rod nut	
BS DESIGN: BS = recirculating ball screw		P05 SCREW PITCH: P05 = 5mm P10 = 10mm P16 = 16mm (for size 40 only) P20 = 20mm (for size 50 only) P25 = 25mm (for size 63 only) P32 = 32mm (for size 80 only) P40 = 40mm (for size 100 only)		VERSION: = IP40 (not available for sizes 80 and 100) P = IP65 (_ _) = extended piston rod _ _mm	

Series 6E Accessories

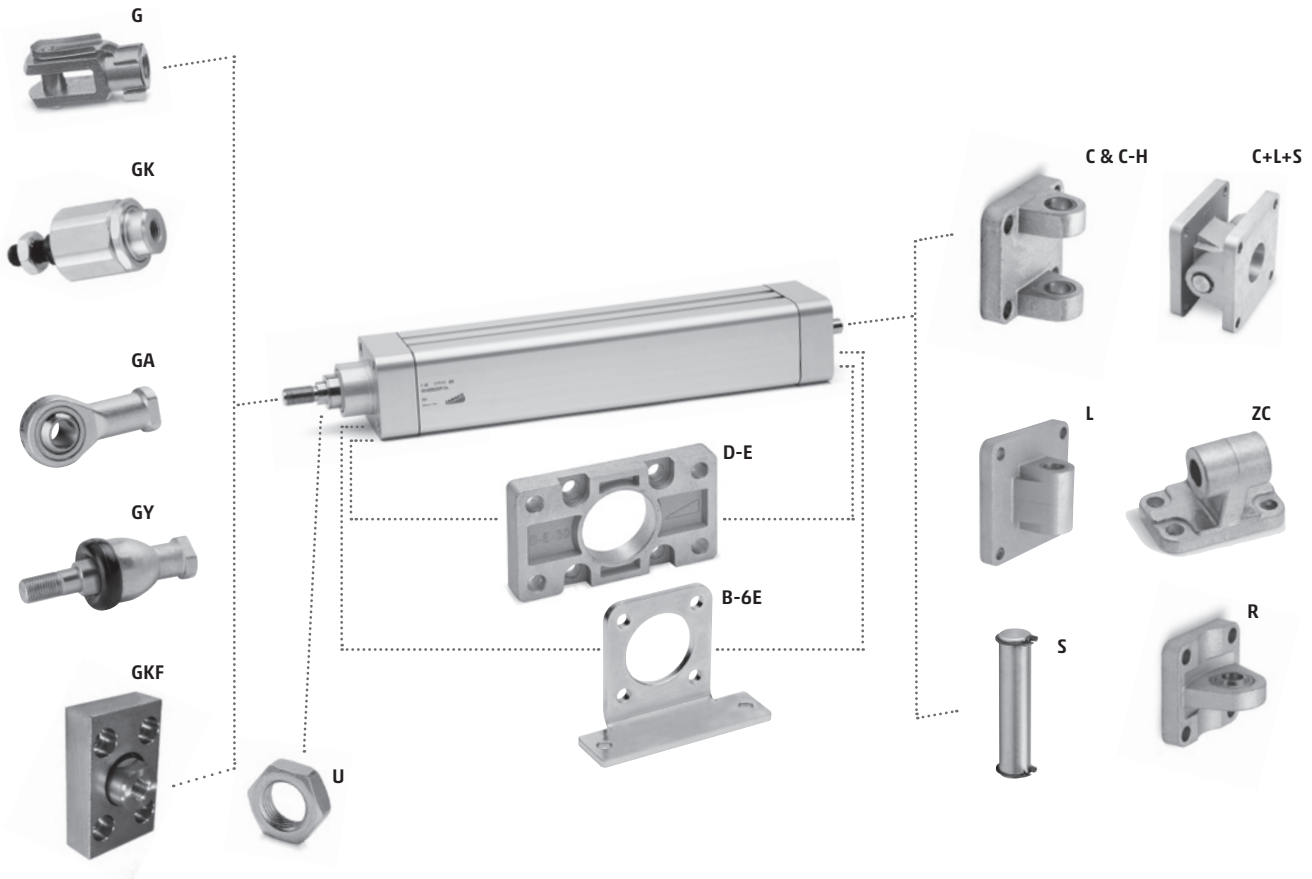

- ✓ Ex Stock
- 🇬🇧 UK Assembly
- ⊗ Please Call Sales Office

Foot Mount (pair)	B-6E	Front and Rear Flange	D-E	Rear Trunnion, Female	C & CH	Swivel Combination	C+L+S
∅		∅		∅		∅	
B-6E-32	32	D-E-41-32	32	C-41-32	32	C+L+S-32	32
B-6E-40	40	D-E-41-40	40	C-41-40	40	C+L+S-40	40
B-6E-50	50	D-E-41-50	50	C-41-50	50	C+L+S-50	50
B-6E-63	63	D-E-41-63	63	C-H-41-63	63	C+L+S-63	63
B-6E-80	80	D-E-41-80	80				
B-6E-100	100	D-E-41-100	100				

Rear Trunnion, Male	L	90° Swivel Trunnion	ZC	Clevis Pin	S	Rear Trunnion Ball Joint	R
∅		∅		∅		∅	
L-41-32	32	ZC 32	32	S-32	32	R-41-32	32
L-41-40	40	ZC 40	40	S-40	40	R-41-40	40
L-41-50	50	ZC 50	50	S-50	50	R-41-50	50
L-41-63	63	ZC 63	63	S-63	63	R-41-63	63
				S-80	80	R-41-80	80
				S-100	100	R-41-100	100

Rod Fork End	G	Self Aligning Rod	GK	Swivel Ball Joint	GA	Piston Rod Socket Joint	GY
∅		∅		∅		∅	
G-25-32	32	GK-25-32	32	GA-32	32	GY-32	32
G-40	40	GK-40	40	GA-40	40	GY-40	40
G-50-63	50-63	GK-50-63	50-63	GA-50-63	50-63	GY-50-63	50-63
G-80-100	80-100	GK-80-100	80-100	GA-80-100	80-100	GY-80-100	80-100

Coupling Piece	GKF	Piston Rod Lock Nut	U
∅		∅	
GKF-25-32	32	U-25-32	32
GKF-40	40	U-40	40
GKF-50-63	50-63	U-50-63	50-63
GKF-80-100	80-100	U-80-100	80-100

Series 6E Accessories

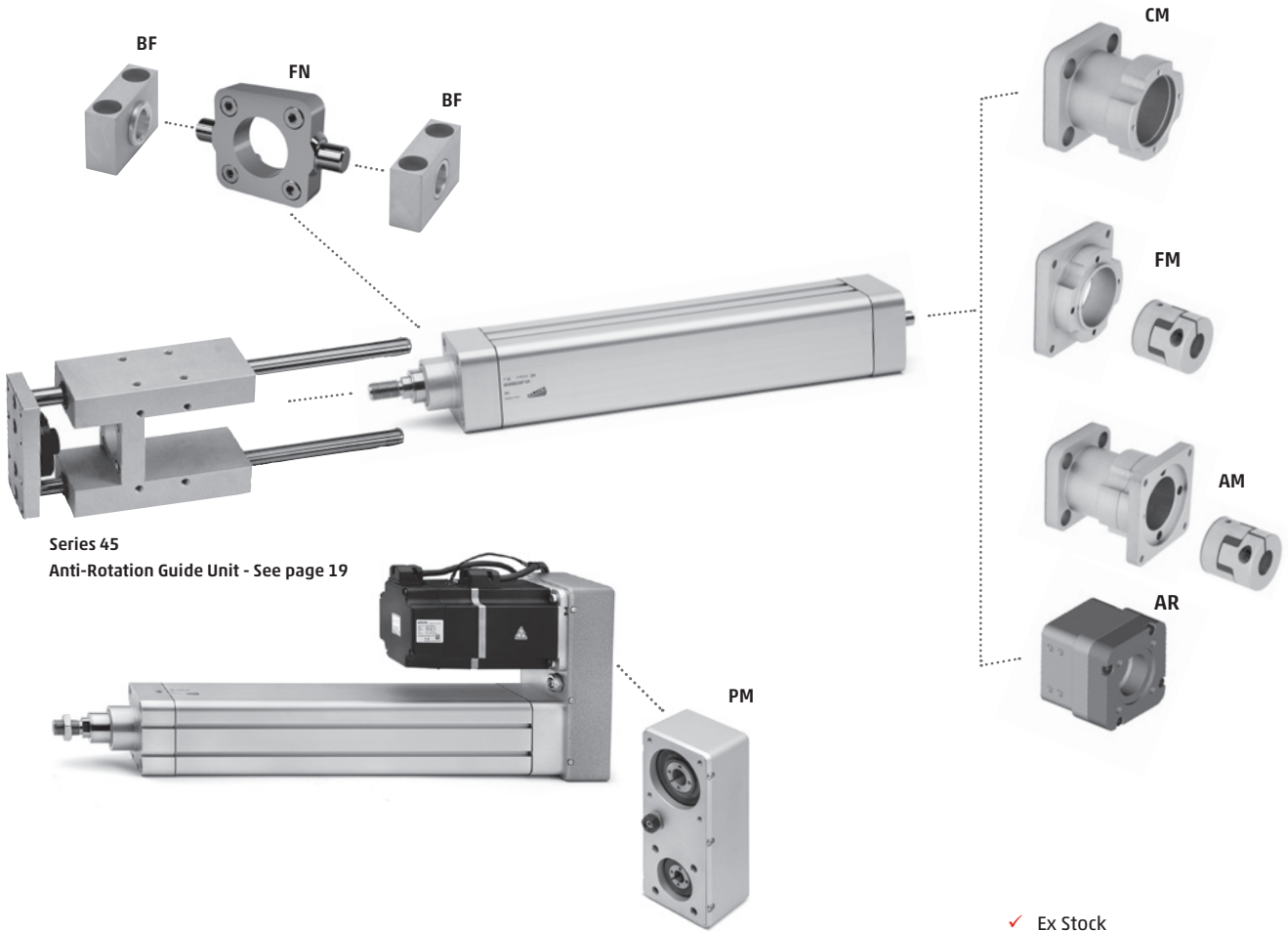

Series 45
Anti-Rotation Guide Unit - See page 19

- ✓ Ex Stock
- 🔧 UK Assembly
- ⌚ Please Call Sales Office

Counter Bracket for Centre Trunnion BF			Centre FN			Kit for parallel connection PM			Housing for axial connection CM		
	∅			∅			∅			∅	
BF-32	32	✓	FN-32	32	⌚	PM-6E-32-0100	32	⌚	CM-6E-32	32	⌚
BF-40-50	40-50	✓	FN-40	40	⌚	PM-6E-40-0400	40	⌚	CM-6E-40	40	⌚
BF-63-80	63-80	✓	FN-50	50	⌚	PM-6E-50-0400	50	⌚	CM-6E-50	50	⌚
BF-100-125	100-125	✓	FN-63	63	⌚	PM-6E-63-0750	63	⌚	CM-6E-63	63	⌚
			FN-80	80	⌚						
			FN-100	100	⌚						

Flange for axial connection FM				Kit for axial connection (IP40) AM			
	∅	Motor			∅	Motor	
FM-6E-32-0100	32	Brushless 100W	(MTB-010-...)	AM-6E-32-0100	32	Brushless 100W	(MTB-010-...)
FM-6E-32-0023	32	Stepper NEMA23	(MTS-23-...)	AM-6E-32-0023	32	Stepper NEMA23	(MTS-23-...)
FM-6E-40-0400	40	Brushless 100W	(MTB-040-...)	AM-6E-40-0400	40	Brushless 100W	(MTB-040-...)
FM-6E-40-0023	40	Stepper NEMA23	(MTS-23-...)	AM-6E-40-0023	40	Stepper NEMA23	(MTS-23-...)
FM-6E-50-0400	50	Brushless 100W	(MTB-040-...)	AM-6E-50-0400	50	Brushless 100W	(MTB-040-...)
FM-6E-50-0024	50	Stepper NEMA23	(MTS-24-...)	AM-6E-50-0024	50	Stepper NEMA23	(MTS-24-...)
FM-6E-63-0750	63	Brushless 100W	(MTB-075-...)	AM-6E-63-0750	63	Brushless 100W	(MTB-075-...)
FM-6E-63-0024	63	Stepper NEMA23	(MTS-24-...)	AM-6E-63-0024	63	Stepper NEMA23	(MTS-24-...)

IP65 versions also available

Kit for axial connection (IP65) AR		
	Size	Gearbox
AR-6E-50-R060P	50	GB-060
AR-6E-63-R060P	63	GB-060
AR-6E-80-R080P	80	GB-080
AR-6E-100-R120P	100	GB-120

Series 5E Electromechanical Axis

Sizes 50, 65, 80

Available versions: standard axis , support axis , reinforced axis

Technical Data

For full technical data please visit
<https://store.camozzi.co.uk>



ACCESSORIES

- ✓ Ex Stock
- ✂ UK Assembly
- 📞 Please Call Sales Office

Reed Switch	Switch Mounting Bracket	Kit to Fix External Sensor	Slot Nut for Sensor CSH	Proximity Switches

Part Number	Availability	Frame Size
Recirculating Ball Screw		
5ES050TBL*	✓	50
5ES065TBL*	✓	65
5ES080TBL*	✓	80

Reed Switch	Switch Mounting Bracket	Kit to Fix External Sensor	Slot Nut for Sensor CSH	Proximity Switches
SKR2C01200	Direct Mount	SIS-M5-50/65	PCV-5E-CS	CSH-253
SKR2C01200	Direct Mount	SIS-M5-50/65	PCV-5E-CS	CSH-253
SKR2C01200	Direct Mount	SIS-M5-50/65	PCV-5E-CS	CSH-253

*Insert stroke length to complete part number

CODING EXAMPLE

5E	S	050	TBL	0200	A	S	2(500)
5E	SERIES: 5E		0200		STROKE (C): 0050 to 4000mm for size 050 0050 to 6000mm for sizes 065 and 080		
S	PROFILE: S = square section		A		VERSION: A = standard axis D = support axis H = reinforced axis (for sizes 65 and 80 only)		
050	FRAME SIZE: 050 = 50x50mm 065 = 65x65mm		080 = 80x80mm		S		
TBL	TRANSMISSION: TBL = toothed belt		2(500)		NUMBER OF SLIDERS: 1 = 1 slider 2(____) = 2 sliders at (____) mm step [only for sliders type "S"]		

Note: All accessories are supplied separately.

Series 5E Accessories

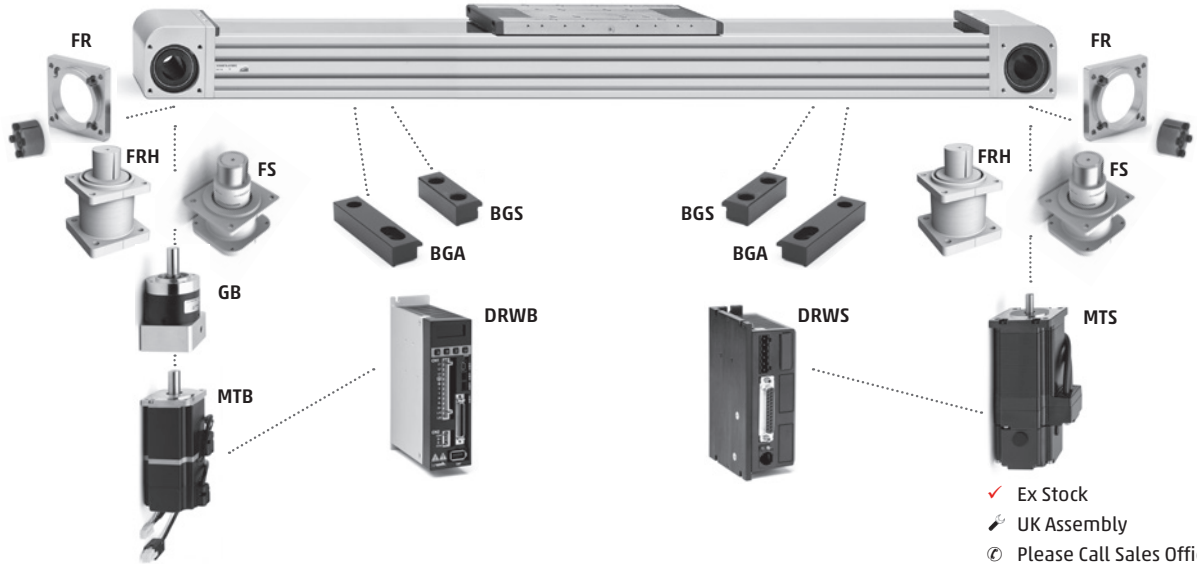

- ✓ Ex Stock
- ✂ UK Assembly
- ⊗ Please Call Sales Office

Slide Clamp	BGS	Perforated Side Clamp	BGA	Gearbox Connection Kit	FR	Enhanced Gearbox Connection	FRH	Direct Stepper Connection	FS
	Size		Size		Size		Size		Size
BGS-5E-M5	50	BGA-5E-M5	50	FR-5E-50	50	FRH-5E-50	50	FS-E5-50-0024	50
BGS-5E-M5	65	BGA-5E-M5	65	FR-5E-65	65	FRH-5E-65	65	FS-E5-65-0024	65
BGS-5E-M5	80	BGA-5E-M5	80	FR-5E-80	80				
BGS-5E-M6	50	BGA-5E-M6	50						
BGS-5E-M6	65	BGA-5E-M6	65						
BGS-5E-M6	80	BGA-5E-M6	80						

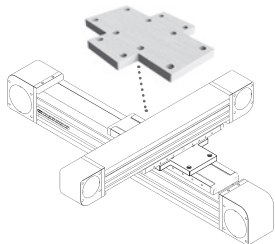

Interface Plate - Slider on Slider		
	∅	
XY-S65-S50	65	⊗
XY-S80-S50	80	⊗
XY-S80-S65	80	⊗

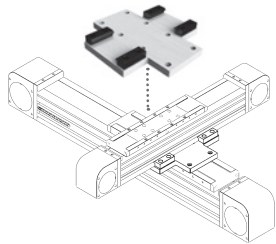

Interface Plate - Profile on Slider		
	∅	
XY-S65-P50	65	⊗
XY-S80-P50	80	⊗
XY-S80-P65	80	⊗

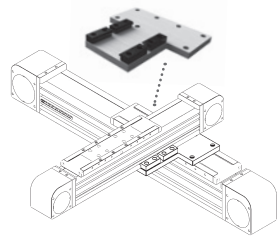

Interface Plate - Profile on Slider Long Arm		
	∅	
XY-S50-P50-T	50	⊗
XY-S65-P50-T	65	⊗
XY-S65-P65-T	65	⊗
XY-S80-P50-T	80	⊗
XY-S80-P65-T	80	⊗
XY-S80-P80-T	80	⊗

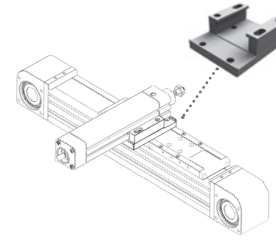

Interface Plate - Cylinder on Slider		
	∅	
XY-S50-6E32	50	⊗
XY-S65-6E32	65	⊗
XY-S65-6E40	65	⊗
XY-S65-6E50	65	⊗
XY-S80-6E32	80	⊗
XY-S80-6E40	80	⊗
XY-S80-6E50	80	⊗
XY-S80-6E63	80	⊗

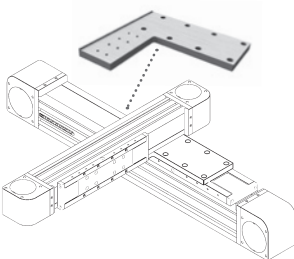

Interface Plate - Profile side on Slider Left Position		
	∅	
XY-S50-LL50	50	⊗
XY-S65-LL50	65	⊗
XY-S65-LL65	65	⊗
XY-S80-LL50	80	⊗
XY-S80-LL65	80	⊗
XY-S80-LL80	80	⊗

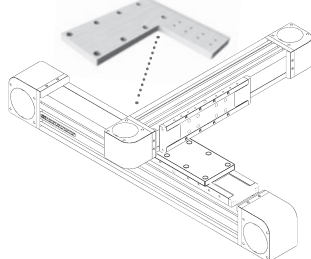

Interface Plate - Profile side on Slider Right Position		
	∅	
XY-S50-LR50	50	⊗
XY-S65-LR50	65	⊗
XY-S65-LR65	65	⊗
XY-S80-LR50	80	⊗
XY-S80-LR65	80	⊗
XY-S80-LR80	80	⊗

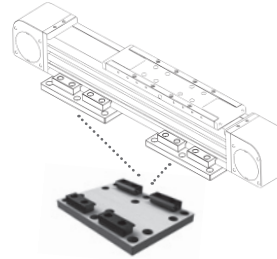

Fixed Interface Plate		
	∅	
X-P50	50	⊗
X-P65	65	⊗
X-P80	80	⊗

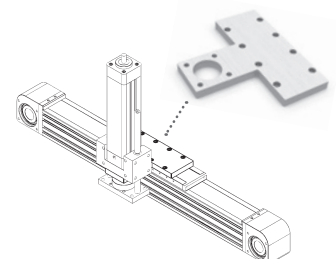

Anti-rotation Interface Plate		
	∅	
XY-S50-45N32	50	⊗
XY-S65-45N32	65	⊗
XY-S65-45N40	65	⊗
XY-S65-45N50	65	⊗
XY-S80-45N40	80	⊗
XY-S80-45N50	80	⊗
XY-S80-45N63	80	⊗

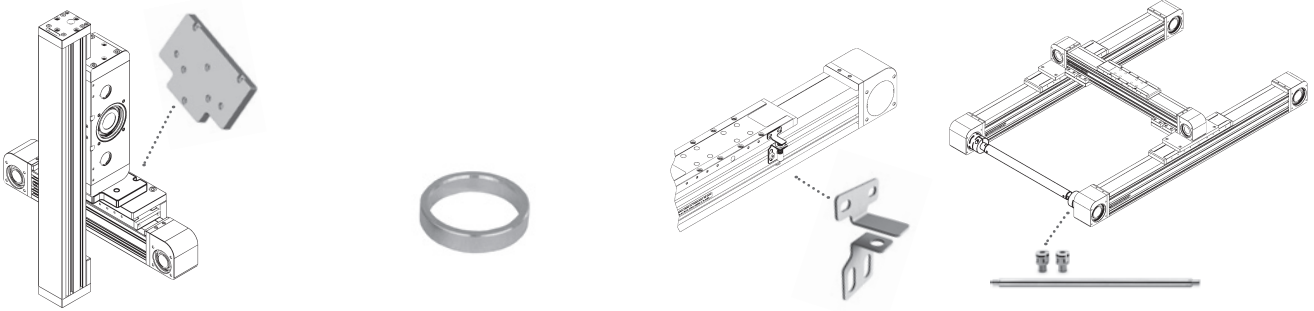

5E / 5V Connection Flange		
	∅	
YZ-50-5V50	50	⊗
YZ-65-5V50	65	⊗
YZ-65-5V65	65	⊗
YZ-80-5V50	80	⊗
YZ-80-5V65	80	⊗
YZ-80-5V80	80	⊗

Centering Ring Series TR-CG		
	M (h8)	
TR-CG-04	∅4	⊗
TR-CG-05	∅5	⊗
TR-CG-06	∅6	⊗
TR-CG-08	∅8	⊗
TR-CG-10	∅10	⊗
TR-CG-12	∅12	⊗

Kit to Fix the Inductive Sensor		
	∅	
SIS-M5-50/65	50-65	⊗
SIS-M8-65	65	⊗
SIS-M5-80	80	⊗
SIS-M8-80	80	⊗

Parallel Connection Kit		
	∅	
PS-5E-50-0000	50	⊗
PS-5E-60-0000	65	⊗
PS-5E-80-0000	80	⊗

Series 5V Vertical Electromechanical Axis

Sizes 50, 63, 80



Technical Data

For full technical data please visit
<https://store.camozzi.co.uk>

ACCESSORIES

- ✓ Ex Stock
- ✂ UK Assembly
- ⊗ Please Call Sales Office

Part Number	Availability	Frame Size
5VS050TBL*	✓	50x50mm
5VS065TBL*	✓	65x65mm
5VS080TBL*	✓	80x80mm

*Insert stroke length to complete part number

Reed Switch	Proximity Swiches
SKR2C01200	CSH-253
SKR2C01200	CSH-253
SKR2C01200	CSH-253

CODING EXAMPLE

5V	S	050	TBL	0200	A	S	1
-----------	----------	------------	------------	-------------	----------	----------	----------

5V	SERIES: 5V						
S	PROFILE: S = Square section	0200	STROKE (C): 0050 - 1500mm	1	NUMBER OF SLIDERS: 1 = 1 Slider		
050	FRAME SIZE: 050 = 50x50mm 065 = 65x65mm 080 = 80x80mm	A	VERSION: A = Standard	TYPE OF END CAP: = Standard SA = Shock absorber integrated			
TBL	TRANSMISSION: TBL = toothed belt	S	TYPE OF SLIDERS: S = Standard				

Series 5V Accessories

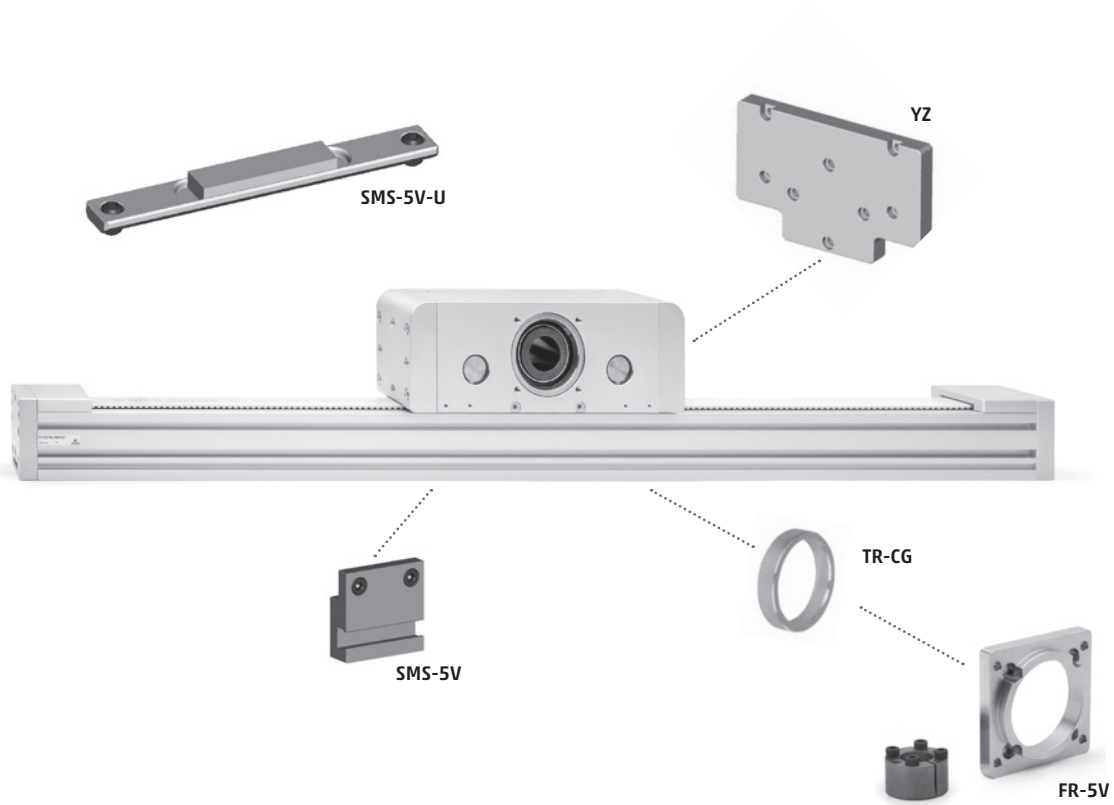

- ✓ Ex Stock
- ✂ UK Assembly
- ☎ Please Call Sales Office

Kit to Connect the Gearbox	FR-5V	Magnet Kit	SMS-5V-U	Sensor Holder Kit	SMS-5V	Centering Ring	TR-CG
	Size				Size		M (h8)
FR-5V-50	50 ✓	SMS-5V-U	✓	SMS-5V-50	50 ✓	TR-CG-04	Ø4 ✓
FR-5V-65	65 ✓			SMS-5V-65/80	65/80 ✓	TR-CG-05	Ø5 ✓
FR-5V-80	80 ✓					TR-CG-06	Ø6 ✓
						TR-CG-08	Ø8 ✓
						TR-CG-10	Ø10 ✓
						TR-CG-12	Ø12 ✓

5E/5V Connection Flange	YZ
	Ø
YZ-50-5V50	50 ✓
YZ-65-5V50	65 ✓
YZ-65-5V65	65 ✓
YZ-80-5V50	80 ✓
YZ-80-5V65	80 ✓
YZ-80-5V80	80 ✓

Series DRWB Drives for the Control of Electric Actuation

Drives for Brushless motors,
sizes in power classes 100, 400, 750, 1000 W

Technical Data

For full technical data please visit
<https://store.camozzi.co.uk>



CODING EXAMPLE

DRWB	-	W01	-	2	-	D	-	E	-	A
DRWB SERIES: DRWB				2 SUPPLY: 2 = 220 V AC				E FEEDBACK: E = incremental encoder 13 bit		
W01 SIZE W: W01 = 100 W W04 = 400 W W07 = 750 W W10 = 1000 W						D COMMUNICATION: D = Digital I/O and Analog				A VERSIONS: A = Standard

Series DRCS Drives for Stepper Motors

One-size full digital drives
with WLAN system and NFC integrated

Technical Data

For full technical data please visit
<https://store.camozzi.co.uk>



CODING EXAMPLE

DRCS	-	A05	-	8	-	D	-	0	-	A
DRCS SERIES: DRCS				8 SUPPLY: 8 = 48 V DC				0 FEEDBACK: 0 = Feedback		
A05 SIZE AT MAX CURRENT: A05 = 7 A						D COMMUNICATION: D = Digital I/O and impulse frequency C = CANopen, Digital I/O and impulse frequency				A VERSIONS: A = Standard B = WLAN BL - BLE

Series MTB Motors for Electric Actuation

Brushless motors in power classes 100, 400, 750, 1000 W

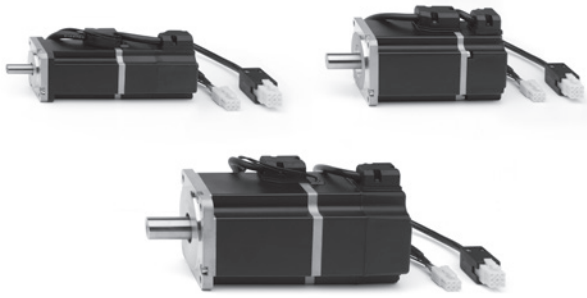

Technical Data

For full technical data please visit
<https://store.camozzi.co.uk>

ELECTRIC ACTUATION

CODING EXAMPLE

MTB	-	010	-	2	-	0	-	E
MTB SERIES: MTB				2 SUPPLY: 2 = 220V DC				E ENCODER: E = incremental 13 bit
010 POWER: 010 = 100 W 040 = 400 W 075 = 750 W 100 = 1000 W				0 BRAKE: 0 = without brake F = with brake				VERSIONS: = Standard P = IP65

Series MTS Motors for Electric Actuation

Stepper motors with Nema 23, 24, 34 Fixing Flange



Technical Data

For full technical data please visit
<https://store.camozzi.co.uk>

CODING EXAMPLE

MTS	-	23	-	18	-	060	-	0	-	0	-	S	-	C
MTS SERIES: MTS								0 ELECTRICAL CONNECTION: 0 = connector						
23 MOTOR SIZE FLANGE CONNECTION: 23 = Nema 23 24 = Nema 24 34 = Nema 34								0 BRAKE: 0 = without brake F = with brake						
18 RESOLUTION IN DEGREES PER REVOLUTION: 18 = 1.8° per step								S ENCODER VARIANTS: S = single shaft without encoder E = single shaft with encoder						
060 TORQUE: 060 = 0.6 Nm with Nema 23 only 120 = 1.2 Nm with Nema 23 IP65 only 250 = 2.5 Nm with Nema 24 only 701 = 7.1 Nm with Nema 34 only								C MECHANICAL SHAFT VARIANTS: C = cylindrical shaft						
														VERSIONS: = Standard P = IP65

Note: All accessories are supplied separately.

Series GB Planetary Gearboxes

Available Sizes: 40, 60, 80, 120



Technical Data

For full technical data please visit
<https://store.camozzi.co.uk>

CODING EXAMPLE

GB	-	040	-	03	-	D	-	0100
GB	GEARBOX		03	REDUCTION RATIO: 03 i = 3 05 i = 5 07 i = 7 10 i = 10		0100	PREPARATION OF THE MOTOR: 0100 = Brushless 100W (size 040 only) 0400 = Brushless 400W (size 060 only) 0750 = Brushless 750W (size 080 only) 1000 = Brushless 1000W (size 120 only) 0024 = Nema 24	
040	SIZE: 040 = Ø40 060 = Ø60 080 = Ø80 120 = Ø120		D	TYPE: D = straight A = angular				

Series CO Motion Transmission Devices

Model COE: Elastomer coupling with clamps

Model COS: Elastomer coupling with expansion shaft

Model COT: Self-centering locking-set



Technical Data

For full technical data please visit
<https://store.camozzi.co.uk>

CODING EXAMPLE

COE	-	10	-	1200	-	1400	-	A
COE	SERIES: COE		1200	HOLE DIAMETER 1: 0635 = 6.35 mm (for sizes 5 and 10 only) 0800 = 8.00 mm (for sizes 5 and 10 only) 1000 = 10.00 mm (for sizes 5 and 10 only) 1100 = 11.00 mm (for size 5 only) 1200 = 12.00 mm (for sizes 10 and 20 only) 1400 = 14.00 mm (for sizes 10, 20 and 60 only) 1500 = 15.00 mm (for sizes 10 and 20 only)		1600 = 16.00 mm (for sizes 10, 20 and 60 only) 1900 = 19.00 mm (for sizes 20 and 60 only) 2000 = 20.00 mm (for sizes 20 and 60 only) 2400 = 24.00 mm (for sizes 20 and 60 only) 2500 = 25.00 mm (for size 60 only) 3200 = 32.00 mm (for size 60 only)		
10	SIZE: 05 10 20 60		1400	HOLE DIAMETER 2: 0635 = 6.35mm (for sizes 5 and 10 only) 0800 = 8.00mm (for sizes 5 and 10 only) 1000 = 10.00mm (for sizes 5 and 10 only) 1100 = 11.00mm (for size 5 only) 1200 = 12.00mm (for sizes 10 and 20 only) 1400 = 14.00mm (for sizes 10, 20 and 60 only) 1500 = 15.00mm (for sizes 10 and 20 only)		1600 = 16.00mm (for sizes 10, 20 and 60 only) 1900 = 19.00mm (for sizes 20 and 60 only) 2000 = 20.00mm (for sizes 20 and 60 only) 2400 = 24.00mm (for sizes 20 and 60 only) 2500 = 25.00mm (for size 60 only) 3200 = 32.00mm (for size 60 only)		
			A	ELASTOMER HARDNESS: A = 98 Sh A B = 64 Sh A (for sizes 10 and 20 only)				

CUSTOMISED SOLUTIONS FOR PNEUMATIC AUTOMATION

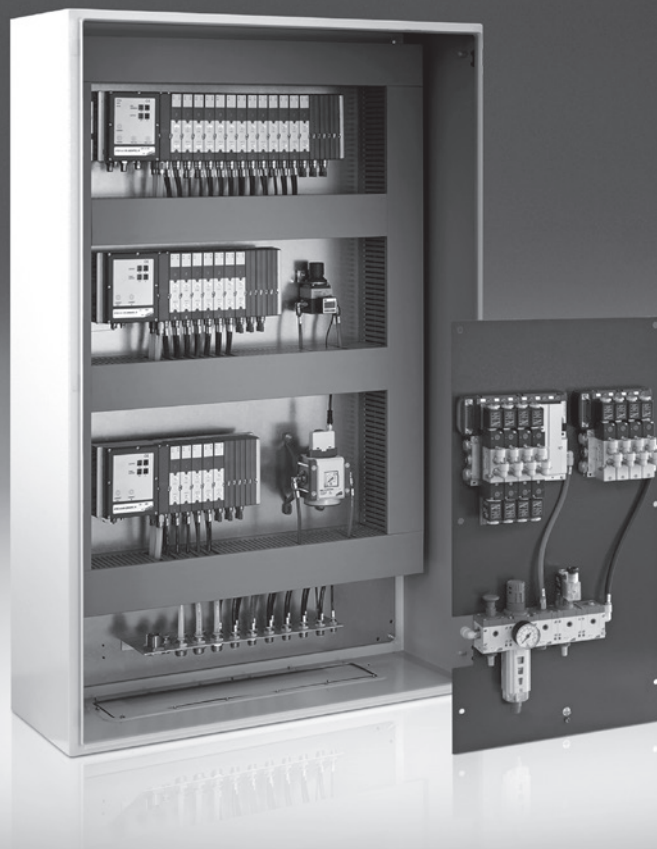

In addition to individual components, Camozzi can supply complete bespoke solutions. Our pre-assembled kits not only enable easy ordering through a single part number, they also arrive ready to perform, so no time is lost in gathering individual components together.

By working closely in union with our customers, we can devise and build special products which are fully tested prior to despatch.

Control cabinets and systems are another Camozzi specialist area, we can integrate electrical and pneumatic components in compact designs, ensuring full compliance with industry standards.

Pre-Assembled Kits
Special Products
Control Cabinets and Systems

Handling & Vacuum







1 Grippers

		Page
New	 Series CGAN Angular Grippers	65
New	 Series CGSY Radial Grippers 180° opening	65
	 Series CGP Parallel Grippers	65
	 Series CGPT Self-Centering Parallel Grippers with T-Guide	65
	 Series CGPS Self-Centering Parallel Grippers with Double Ball Bearing Guide	65
	 Series CGLN Wide Opening Parallel Grippers	66
New	 Series CGZT Three-Jaw Grippers with T-Guide	66
New	 Series CGCN Self-Centering Three-Finger Grippers with T-Guide	66
	 Series RPGA Sprue Grippers Size 20 mm	67
	 Series RRGB Sprue Grippers Size 8, 12 mm	67



2 Suction Pads

		Page
	 Series VTFC Flat Suction Pads (round)	67
	 Series VTOF Flat Suction Pads (oval)	67
	 Series VTCL Bellows Suction Pads (round) 1.5 folds	67
	 Series VTCN Bellows Suction Pads (round) 2.5 Folds	67

3 Ejectors Based on Venturi Principle

		Page
	 Series VEB Basic Ejectors	67
	 Series VEBL Basic Ejectors	67
	 Series VED Inline Ejectors	68
	 Series VEDL Inline Ejectors	68
	 Series VEC Compact Ejectors	68
	 Series VEM Compact Ejectors	68

4 Accessories

		Page
	 Series NPF Flexible Suction Pad Mountings	68
	 Series NPM, NPR Spring Plungers (non rotating)	68
	 Series VNV Check Valves	68

5 Filters

		Page
	 Series FVD Inline Vacuum Filters	68
	 Series FVT Vacuum Cup Filters	68

Series CGAN Angular Grippers

New

Double acting, magnetic, self centering

Ø 10, 16, 20, 25, 32 mm

Technical Data
Operating Pressure
2 bar to 8 bar
Operating Temperature
5°C to 60°C.

CODING EXAMPLE

CGAN	-	20	-	EX
CGAN	SERIES: CGAN			
20	SIZES: 10 = Ø10mm 16 = Ø16mm 20 = Ø20mm 25 = Ø25mm 32 = Ø32mm			
EX	Add EX to order the certified ATEX version			



Series CGSY Radial Grippers 180° opening

New

Double acting, magnetic, self-centering

Ø 10, 16, 20, 25 mm

Technical Data
Operating Pressure
2 bar to 8 bar
Operating Temperature
5°C to 60°C.

CODING EXAMPLE

CGSY	16	EX
CGSY	SERIES: CGSY	
16	SIZES: 10 = Ø10mm 16 = Ø16mm 20 = Ø20mm 25 = Ø25mm	
EX	Add EX to order the certified ATEX version	



Series CGP Parallel Grippers

Magnetic

Ø 10, 16, 20, 25, 32 mm

Technical Data
Operating Pressure
1.5 bar to 7 bar
Operating Temperature
0°C to 80°C.



CODING EXAMPLE

CGP	-	20
CGP	SERIES: CGP	
20	SIZES: 10 = Ø10mm 16 = Ø16mm 20 = Ø20mm 25 = Ø25mm 32 = Ø32mm	

Series CGPT Parallel Grippers

Magnetic

Ø 16, 20, 25, 32, 40 mm

Technical Data
Operating Pressure
2 to 8 bar (double-acting)
4 to 8 bar (single-acting)
Operating Temperature
5°C to 60°C (standard)
-5°C to 150°C (high temperature version)



CODING EXAMPLE

CGPT	-	16	-	NC	-	W	EX
CGPT	SERIES: CGPT	NC	FUNCTIONING: = double acting NO = single acting, normally open NC = single acting, normally closed	W	VERSION: = standard W = high temperatures (150°C) - not magnetic	EX	Add EX to order the certified ATEX version
16	BORES: 10 = Ø10mm 16 = Ø16mm 20 = Ø20mm 25 = Ø25mm 32 = Ø32mm 40 = Ø40mm						

Series CGPS Self-Centering Parallel Grippers with Double Ball Bearing Guide

Single-acting and double-acting, magnetic, self-centering
Ø10, 16, 20, 25 mm

Technical Data
Operating Pressure
2 to 8 bar (double-acting)
4 to 8 bar (single-acting)
Operating Temperature
5°C to 60°C. (standard)
5°C to 150°C (high temperature version)



CODING EXAMPLE

CGPS	-	L	-	16	-	NO	-	W	EX		
CGPS	SERIES: CGPS	16	BORES: 10, 16, 20, 25, 32	W	VERSION: = standard W = high temperatures (150°C)	L	DESIGN TYPE: L = Long finger F = Flat finger	NO	FUNCTIONING: = double acting NO = single acting, normally open NC = single acting, normally closed	EX	Add EX to order the certified ATEX version

Series CGLN Wide Opening Parallel Grippers

Magnetic
Ø 10, 16, 20, 25, 32 mm

Technical Data
Operating Pressure
2 to 8 bar (3 - 8 bar for Ø10)
Operating Temperature
5°C to 60°C



Series CGZT Three-Jaw Grippers with T-Guide

New

Single and double acting,
magnetic, self-centering
Sizes: 40, 50, 64, 80,
100, 125, 160 mm

Technical Data
Operating Pressure
2 to 8 bar (Double acting)
4 to 8 bar (Single acting)
Operating Temperature
5°C to 60°C (standard)
-5°C to 130°C (high temperature
version)



CODING EXAMPLE

CGLN - **20** - **040**

CGLN	SERIES: CGLN	040	STROKE: 020 = Ø20mm 030 = Ø30mm 040 = Ø40mm 050 = Ø50mm 060 = Ø60mm 070 = Ø70mm 080 = Ø80mm 100 = Ø100mm 120 = Ø120mm 160 = Ø160mm
20	VERSION: 10 = Ø10mm 16 = Ø16mm 20 = Ø20mm 25 = Ø25mm 32 = Ø32mm		

CODING EXAMPLE

CGZT - **050** - **NC** - **W** **EX**

CGZT	SERIES: CGZT	NC	FUNCTIONING: = double acting NO = single acting, normally open NC = single acting, normally closed
50	SIZES: 040 = Ø25 050 = Ø33 064 = Ø43 080 = Ø54 100 = Ø76 125 = Ø96 160 = Ø125	W	VERSION: = standard W = high temperatures (150°C) - not magnetic
		EX	Add EX to order the certified ATEX version

Series CGCN Self-Centering Three-Jaw Grippers with T-guide

New

Magnetic, Double Acting
Ø 50, 64, 80, 100, 125 mm

Technical Data
Operating Temperature
5°C to 60°C
Operating Pressure
2 bar to 8 bar



CODING EXAMPLE

CGCN - **050** - **EX**

CGCN	SERIES: CGCN	050	SIZES: 050 = Ø32 064 = Ø45 080 = Ø54 100 = Ø76 125 = Ø96	EX	VERSIONS: = standard EX = ATEX certified
-------------	--------------	------------	---	-----------	--

Series RPGA Sprue Grippers - Size 20mm



Technical Data
Operating Pressure
 2.5 to 8 bar
Operating Temperature
 0°C to 60°C.

CODING EXAMPLE

RPGA	-	20	-	A
-------------	---	-----------	---	----------

RPGA	SERIES: RPGA	A	TYPE OF CONSTRUCTION: A = Flat Finger B = Curved Finger C = Short Finger with holes for extra jaws D = Flat Finger for sensor E = Curved Finger for sensor
20	SIZE: 20 = Ø20mm		

Series RPGB Sprue Grippers - Size 8-12mm



Technical Data
Operating Pressure
 2.5 to 8 bar
Operating Temperature
 0°C to 60°C.

CODING EXAMPLE

RPGB	-	12	-	A
-------------	---	-----------	---	----------

RPGB	SERIES: RPGB	A	TYPE OF CONSTRUCTION: A = Flat Finger C = Short Finger with holes for extra jaws D = Flat Finger with sensor mounted (mod. CSD-362)
12	VERSION: 08 = Ø8mm 12 = Ø12mm		

Series VTCF Flat Suction Pads (round)

Diameters from 3.5 to 95 mm with thread size M3, M5, 1/8, 1/4, both male and female.



Series VTOF Flat Suction Pads (oval)

Diameters from 7x3.5 to 60x20 mm with thread size M3, M5, 1/8, 1/4, both male and female.



Series VTCL (1.5 folds) Bellows Suction Pads (round)

Diameters from 11 to 53 mm with thread size M5, 1/8, 1/4, both male and female.



Series VTCN (2.5 folds) Bellows Suction Pads (round)

Diameters from 5 to 52 mm with thread size M5, 1/8, 1/4, both male and female.



Series VEB Basic Ejectors

Version "L" for porous workpieces, version "H" for high vacuum valve.



Series VEBL Basic Ejectors

Different sizes available, with internal nozzle from 0.5 to 2.5mm and with suction rate from 8 to 207 l/min.



Series VED Inline Ejectors

Vacuum ejectors without moving parts, based on the Venturi principle, used for direct installation on suction pads.



Series VEDL Inline Ejectors

Available in two sizes with internal nozzle of 0.5 and 0.7mm and with suction rate from 8 to 16 l/min.



Series VEC Compact Ejectors

Possibility to command suction and blow-off individually without using external valves.



Series VEM Compact Ejectors

Possibility to command suction and blow-off individually without using external valves.



Series NPF Flexible Suction Pad Mountings

Thread 1/4.



Series NPM - NPR Spring Plungers (non rotating)

Thread size M3, M5, 1/8, 1/4, plunger stroke length from 5 to 75mm.



Series VNV Check Valves

Thread size M5, 1/8, 1/4, 3/8, 1/2.



Series FVD Inline Vacuum Filters

Direct mounting on the suction pad.



Series FVT Vacuum Cup Filters

Mounted as protection for the ejector.



Technical Data Sheets



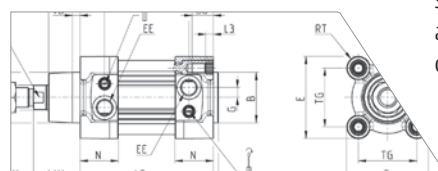

Full technical data sheets available at: <https://store.camozzi.co.uk>













Valves and Solenoid Valves







1 Directly and Indirectly Operated 2/2 - 3/2 Solenoid Valves

	Page
 Series P Directly operated solenoid valves	71
 Series A Directly operated solenoid valves	73
 Series 6 Directly operated solenoid valves	75

2 Solenoid, Pneumatic and Manifold Valves

	Page
 Series E Valves and solenoid valves	77
 Series E Accessories	82
 Series EN Valves and solenoid valves	83
 New Series D Valves and solenoid valves	95
 Series 3 and 4 Electropneumatically operated valves	105
 Series 3 and 4 Pneumatically operated valves	118
 Series 9 Valves and solenoid valves ISO 5599/1	128
 Series NA Valves and solenoid valves	132
 U7* - U7*EX - G7* - A8* - G93 - B* - H8 and GP* Solenoid coils	133
 Solenoid DIN connectors	134







3 Mechanical and Manual Valves

	Page
 Series 2 Mechanically operated minivalves	138
 Series 1, 3 Mechanically operated valves	140
 Series 3, 4 Mechanically operated sensor valves	144
 Series 2, 3 Foot operated pedal electrical and pneumatic	147
 Series 2 Manually operated console minivalves	148
 Series 1, 3, 4 VMS Manually operated valves	152
 Series 2 Mini-handle valves	158







4 Logic Valves

	Page
 Series 2L Basic logic valves	158

5 Automatic Valves

		Page
	Mod. SCS Circuit selector	160
	Series VNR Unidirectional valves (with Tube Connections)	160
	Series VNR Unidirectional valves	161
	Series VSO, VSC Quick exhaust valves	161
	Series VMR Adjustable over pressure exhaust valve	161
	Series VBO, VBU Blocking valves	162

6 Flow Control Valves

		Page
	Series SCU, MCU, SVU, MVU, SCO, MCO Flow control valves	163
	Series PSCU, PMCU, PSVU, PMVU, PSCO, PMCO Flow control valves	167
	Series GSCU, GMCU, GSVU, GMVU, GSCO, GMCO Flow control valves	168
	Series TMCU, TMVU, TMCO Flow control valves	169
	Series RFU, RFO Flow control valves	170
	Series 28 Flow control valves	171

7 Silencers

		Page
	Series 29... Silencers	173

Series P Directly Operated Mini-Solenoid Valves - 15mm

3/2 Way N.C. or N.O.

Connection: M5 (for single base), ø3mm and ø4mm cartridge (for manifolds).

ISO 15218 Interface

The Camozzi range of Series P Directly Operated Mini-Solenoid Valves can work with dry or lubricated air.

3/2-way NC Solenoid Valves

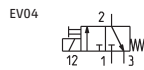

- ✓ Ex Stock
- ✎ UK Assembly
- ☎ Please Call Sales Office

Part Number	Availability	Function	Symbol	Flow Rate (NI/min) (6 bar ΔP 1 bar)	Operating Pressures (Bar)
P000-301-P53	✓	3 way NC	EV04	14	0-10
P000-303-P53	✓	3 way NC	EV04	35	0-7
P000-305-P53	✓	3 way NC	EV04	25	0-10
P000-306-P53	✓	3 way NC	EV04		0-3

Technical Data

Media

Filtered air, inert gas

Operating Temperature

0°C to +50°C

Full Data Sheet and Dimensions at <https://store.camozzi.co.uk>

ACCESSORIES

SOLENOID DIN CONNECTORS	SOLENOID DIN CONNECTORS WITH MOULDED CABLE (3M)
-------------------------	---



KD136000B7	MD134000PA01300
KD136000B7	MD134000PA01300
KD136000B7	MD134000PA01300
KD136000B7	MD134000PA01300

For more connector options, including LED versions please see page 134-137

3/2-way NO Solenoid Valves

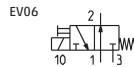

Part Number	Availability	Function	Symbol	Flow Rate (NI/min) (6 bar ΔP 1 bar)	Operating Pressures (Bar)
P000-405-P53	✓	3 way NO	EV06	15	0-10
P000-403-P53	✓	3 way NO	EV06	-	0-5

SOLENOID DIN CONNECTORS	SOLENOID DIN CONNECTORS WITH MOULDED CABLE
-------------------------	--



KD136000B7	MD134000PA01300
KD136000B7	MD134000PA01300

For more connector options, including LED versions please see page 134-137

CODING EXAMPLE

P	0	00	-	3	0	3	-	P	5	3
P SERIES: P										
0 BODY DESIGN: 0 = single sub-base or interface 1 = single manifold 2 = double sided manifold			3 NOMINAL DIAMETER: Nominal Diameter Max. Pressure 1 = Ø0.8 (1W) 10 bar (NC) 24V only 3 = Ø1.5 (2W) 7 bar (NC) 5 bar (NO) 5 = Ø1.1 NC (2W) 10 bar (NC) Ø0.9 NO (2W) 10 bar (NO) 6 = Ø1.5 NC (2W) 3 bar (NC)* *Voltage tolerance +10% -25%							
00 N° OF SEGMENTS: 00 = interface 01 = single base (M5 only) 02-99 = manifold number of positions			P MATERIAL: P = technopolymer PBT body, FKM poppet seal, other seals in NBR (FKM on demand)							
3 N° OF CONNECTIONS AND FUNCTIONS: 0 = manifold or single base 3 = 3-ways N.C. 4 = 3-ways N.O. 5 = 3-ways N.C. electric part revolved by 180° 6 = 3-ways N.O. electric part revolved by 180°			5 SOLENOID DIMENSION: 5 = 3 faston size 9.4mm							
0 CONNECTIONS: 0 = interface (for single valve only) MANIFOLD CONNECTIONS (for series W, P and PN): 2 = M5 side connection 3 = Ø3 tube side connection 4 = Ø4 tube side connection 6 = M5 rear connection 7 = Ø3 tube rear connection 8 = Ø4 tube rear connection			3 SOLENOID VOLTAGE: B = 24V 50/60 Hz - on request C = 48V 50/60 Hz - on request D = 110V 50/60 Hz - on request 2 = 12V DC - on request 3 = 24V DC - Standard 4 = 48V DC - on request 6 = 110V DC - on request							

Manifolds

- ✓ Ex Stock
- ✎ UK Assembly
- ⓞ Please Call Sales Office

Single manifold rear outlets



*7= Ø3
*8= Ø4

M5 available on request

Single manifold front outlets



*3= Ø3
*4= Ø4

M5 available on request

Double-sided manifold rear outlets



*7= Ø3
*8= Ø4

M5 available on request

Double-sided manifold front outlets



*3= Ø3
*4= Ø4

M5 available on request

Part Number	Availability	Part Number	Availability	Part Number	Availability	Part Number	Availability
P102-0* (2 valves)	ⓞ	P102-0* (2 valves)	ⓞ	P204-0* (4 valves)	ⓞ	P204-0* (4 valves)	ⓞ
P103-0* (3 valves)	ⓞ	P103-0* (3 valves)	ⓞ	P206-0* (6 valves)	ⓞ	P206-0* (6 valves)	ⓞ
P104-0* (4 valves)	ⓞ	P104-0* (4 valves)	ⓞ	P208-0* (8 valves)	ⓞ	P208-0* (8 valves)	ⓞ
P105-0* (5 valves)	ⓞ	P105-0* (5 valves)	ⓞ	P210-0* (10 valves)	ⓞ	P210-0* (10 valves)	ⓞ
P106-0* (6 valves)	ⓞ	P106-0* (6 valves)	ⓞ	P212-0* (12 valves)	ⓞ	P212-0* (12 valves)	ⓞ



Part Number	Availability	Thread	Part Number	Availability	Thread
P001-02	✓	M5 Ports	P000-TP	✓	M5 Ports

Series A Directly Operated Solenoid Valves

2/2-way - Normally Closed (NC) and Normally Open (NO)
3/2-way - Normally Closed (NC) and Normally Open (NO)

The Camozzi range of Series A Directly Operated Solenoid Valves can be used with dry or lubricated air.

2/2 and 3/2-way solenoid valves A32 and A33



Technical Data
Media
Filtered air, inert gas
Operating Temperature
0°C to +60°C
(with dry air -20°C)
Full Data Sheet and Dimensions at
<https://store.camozzi.co.uk>

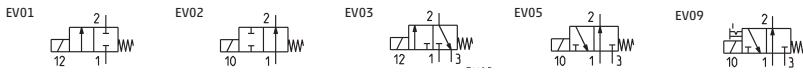

- ✓ Ex Stock
- 🔧 UK Assembly
- 📞 Please Call Sales Office

Part Number	Availability	Thread	Function	Symbol	Flow Rate (NI/min)	Operating Pressures (Bar)		
						Sol. 3W	Sol. 4-5W	Sol. 3.5VA
A321-0C2-*	✓	M5	2/2 N.C.	EV01	50	-0.9 - 8	-0.9 - 15	-0.9 - 15
A321-1C2-*	✓	1/8	2/2 N.C.	EV01	55	-0.9 - 8	-0.9 - 15	-0.9 - 15
A321-1D2-*	✓	1/8	2/2 N.C.	EV01	100	-0.9 - 4	-0.9 - 9	-0.9 - 9
A321-1E2-*	✓	1/8	2/2 N.C.	EV01	130	-0.9 - 1	-0.9 - 6	-0.9 - 6
A322-0C2-*	✓	M5	2/2 N.O.	EV02	70	2 - 10	-0.9 - 10	-0.9 - 10
A322-1C2-*	✓	1/8	2/2 N.O.	EV02	80	2 - 10	-0.9 - 10	-0.9 - 10
A331-0C2-*	✓	M5	3/2 N.C.	EV03	50	2 - 10	-0.9 - 10	-0.9 - 10
A331-1C2-*	✓	1/8	3/2 N.C.	EV03	60	2 - 10	-0.9 - 10	-0.9 - 10
A332-0C2-*	✓	M5	3/2 N.O.	EV09	55	-0.9 - 7	-0.9 - 7	-0.9 - 7
A332-1C2-*	✓	1/8	3/2 N.O.	EV09	50	-0.9 - 7	-0.9 - 7	-0.9 - 7
A333-0C2-*	✓	M5	3/2 N.O.	EV05	60	-0.9 - 7	-	-0.9 - 10
A333-1C2-*	✓	1/8	3/2 N.O.	EV05	60	-0.9 - 7	-	-0.9 - 10

*Coil sold separately, see page opposite for voltage options (U7 Solenoid Coils)

ACCESSORIES

SOLENOID COILS	CONNECTOR	STRAIGHT CONNECTION	ELBOW FITTING
----------------	-----------	---------------------	---------------



U7*	KB132000B9	6512 4-M5	6522 4-M5
U7*	KB132000B9	6512 6-1/8	6522 6-1/8
U7*	KB132000B9	6512 6-1/8	6522 6-1/8
U7*	KB132000B9	6512 6-1/8	6522 6-1/8
U7*	KB132000B9	6512 4-M5	6522 4-M5
U7*	KB132000B9	6512 6-1/8	6522 6-1/8
U7*	KB132000B9	6512 4-M5	6522 4-M5
U7*	KB132000B9	6512 6-1/8	6522 6-1/8
U7*	KB132000B9	6512 4-M5	6522 4-M5
U7*	KB132000B9	6512 6-1/8	6522 4-M5

For more connector options, including LED versions please see page 134-137

3/2-way solenoid valves AA31 and AA33



Part Number	Availability	In/Out	Function	Symbol	Flow Rate (NI/min)	Operating Pressures (Bar)		
						Sol. 3W	Sol. 4-5W	Sol. 3.5VA
AA31-0C2-*	✓	1/8-M5	3/2 N.C.	EV08	55	2 - 10	-0.9 - 10	-0.9 - 10
AA31-CC2-*	✓	1/8-Ø4	3/2 N.C.	EV08	55	2 - 10	-0.9 - 10	-0.9 - 10
AA31-0C3-*	✓	1/8-M5	3/2 N.C.	EV08	55	2 - 8	-0.9 - 8	-0.9 - 8
AA31-CC3-*	✓	1/8-Ø4	3/2 N.C.	EV08	55	2 - 8	-0.9 - 8	-0.9 - 8
AA33-0C2-*	✓	1/8-M5	3/2 N.O.	EV05	55	-0.9 - 7	-	-0.9 - 10
AA33-CC2-*	✓	1/8-Ø4	3/2 N.O.	EV05	55	-0.9 - 7	-	-0.9 - 8
AA33-0C3-*	✓	1/8-M5	3/2 N.O.	EV05	65	-0.9 - 7	-	-0.9 - 8
AA33-CC3-*	✓	1/8-Ø4	3/2 N.O.	EV05	65	-0.9 - 7	-	-0.9 - 8

*Coil sold separately, see page opposite for voltage options (U7 Solenoid Coils)

SOLENOID COILS	CONNECTOR	STRAIGHT CONNECTION	INLET FITTING
----------------	-----------	---------------------	---------------



U7*	KB132000B9	6512 4-M5	6522 4-M5
U7*	KB132000B9	6512 6-1/8	6522 6-1/8
U7*	KB132000B9	6512 6-1/8	6522 6-1/8
U7*	KB132000B9	6512 6-1/8	6522 6-1/8
U7*	KB132000B9	6512 6-1/8	6522 6-1/8
U7*	KB132000B9	6512 6-1/8	6522 6-1/8
U7*	KB132000B9	6512 6-1/8	6522 6-1/8
U7*	KB132000B9	6512 6-1/8	6522 6-1/8

For more connector options, including LED versions please see page 134-137

3/2-way solenoid valve A33



Part Number	Availability	In/Out	Function	Symbol	Flow Rate (NI/min)	Operating Pressures (Bar)		
						Sol. 3W	Sol. 4-5W	Sol. 3.5VA
A331-3C2-*	✓	M5-1/8	3/2 N.C.	EV03	55	2 - 10	-0.9 - 10	-0.9 - 10
A331-4C2-*	✓	M5-1/8	3/2 N.C.	EV08	55	2 - 10	-0.9 - 10	-0.9 - 10

*Coil sold separately, see page opposite for voltage options (U7 Solenoid Coils)

SOLENOID COILS	CONNECTOR	STRAIGHT CONNECTION	OUTLET FITTING
----------------	-----------	---------------------	----------------



U7*	KB132000B9	6512 4-M5	6522 4-M5
U7*	KB132000B9	6512 4-M5	6522 4-M5

For more connector options, including LED versions please see page 134-137

The company reserves the right to vary models and dimensions without notice. Products designed for industrial applications. General terms and conditions for sale are available on www.camozzi.co.uk

3/2-way solenoid valve A43

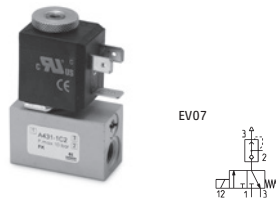

Part Number	Availability	Thread	Function	Symbol	Flow Rate (NI/min)	Operating Pressures (Bar)		
						Sol. 3W	Sol. 4-5W	Sol. 3.5VA
A431-1C2-*	✓	1/8	3/2 N.C.	EV07	50	2 - 10	2 - 10	2 - 10

*Coil sold separately, see below for voltage options (U7 Solenoid Coils)

ACCESSORIES

SOLENOID COILS	CONNECTOR	STRAIGHT CONNECTION	ELBOW FITTING
----------------	-----------	---------------------	---------------



U7* KB132000B9 6512 6-1/8 6522 6-1/8

For more connector options, including LED versions please see page 134-137

3/2-way solenoid valve A63

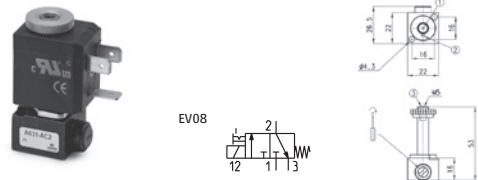

Part Number	Availability	Interface	Function	Symbol	Flow Rate (NI/min)	Operating Pressures (Bar)		
						Sol. 3W	Sol. 4-5W	Sol. 3.5VA
A631-AC2-*	✓	OR	3/2 N.C.	EV08	40	2 - 10	-0.9 - 10	-0.9 - 10

*Coil sold separately, see below for voltage options (U7 Solenoid Coils)

SOLENOID CONNECTOR COILS



U7* KB132000B9

For more connector options, including LED versions please see page 134-137

3/2-way solenoid valve A53

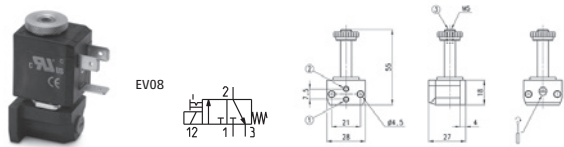

Part Number	Availability	Interface	Function	Symbol	Flow Rate (NI/min)	Operating Pressures (Bar)		
						Sol. 3W	Sol. 4-5W	Sol. 3.5VA
A531-BC2-*	✓	OR	3/2 N.C.	EV08	40	2 - 10	-0.9 - 10	-0.9 - 10

*Coil sold separately, see below for voltage options (U7 Solenoid Coils)

SOLENOID CONNECTOR COILS



U7* KB132000B9

For more connector options, including LED versions please see page 134-137

CODING EXAMPLE

A	3	3	1	-	0	C	2	-	U	7	7
---	---	---	---	---	---	---	---	---	---	---	---

A SERIES:	3 BODY DESIGN: 1 = base (24 x 24 mm) interface rotatable through 360° 2 = base (24 x 24 mm) fixed interface 3 = threaded body 4 = rapid exhaust body 5 = base with ISO standard interface, fixed 6 = base (16 x 16 mm) interface rotatable through 360° For other options please contact our sales office.	0 CONNECTIONS: <table border="1"> <thead> <tr> <th></th> <th>1</th> <th>2</th> <th>3</th> </tr> </thead> <tbody> <tr> <td>0</td> <td>M5</td> <td>M5</td> <td>M5</td> </tr> <tr> <td>1</td> <td>1/8</td> <td>1/8</td> <td>M5</td> </tr> <tr> <td>3</td> <td>M5</td> <td>1/8 male</td> <td>M5</td> </tr> <tr> <td>4</td> <td>M5</td> <td>1/8 male</td> <td>M5 with manual override</td> </tr> <tr> <td>A</td> <td>swivel O-ring interface</td> <td>-</td> <td>M5</td> </tr> <tr> <td>B</td> <td>fixed O-ring interface</td> <td>-</td> <td>M5</td> </tr> <tr> <td>C</td> <td>cartridge Ø4</td> <td>-</td> <td>-</td> </tr> </tbody> </table>		1	2	3	0	M5	M5	M5	1	1/8	1/8	M5	3	M5	1/8 male	M5	4	M5	1/8 male	M5 with manual override	A	swivel O-ring interface	-	M5	B	fixed O-ring interface	-	M5	C	cartridge Ø4	-	-	U SOLENOID MATERIAL: G = Nylon U = PET A = PPS H = PA6VO
	1	2	3																																
0	M5	M5	M5																																
1	1/8	1/8	M5																																
3	M5	1/8 male	M5																																
4	M5	1/8 male	M5 with manual override																																
A	swivel O-ring interface	-	M5																																
B	fixed O-ring interface	-	M5																																
C	cartridge Ø4	-	-																																
3 N° OF CONNECTIONS: 2 = 2 way 3 = 3 way	C NOMINAL DIAMETER: C = Ø1.5 D = Ø2 E = Ø2.5	7 SOLENOID DIMENSIONS: 7 = 22 x 22 8 = 30 x 30 9 = 22 x 58																																	
1 FUNCTION: 1 = NC (normally closed) 3 = NO (in line) 2 = NO (normally open)	2 BODY MATERIAL: 2 = nickel-plated brass 3 = technopolymer	7 SOLENOID VOLTAGE: See page 133																																	

U7* Solenoid Coils

Solenoid Voltages U7 (Material = PET)	
U7H	24V 50/60 Hz 3.5VA
	12V DC 3.1W
U7K	110V AC 50/60Hz 4.3VA
	125V AC 50/60Hz 5.5VA

Solenoid Voltages U7 (Material = PET)	
U7J	230V 50/60Hz 3.5VA
	240V 50/60Hz 4VA
U77	24V DC 5W



For full range of solenoid coils please see page 133

Series 6 Directly Operated Solenoid Valves

2/2-way - Normally Closed (NC)

3/2-way - Normally Closed (NC), Normally Open (NO)

Connection: 1/8, 3/8, ø4mm cartridge

Available also in version for low temperatures up to -50°C

The Camozzi range of Series 6 Directly Operated Solenoid Valves can be used with dry or lubricated air.

3/2-way NC and NO solenoid valve, 1/8

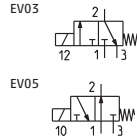

- ✓ Ex Stock
- ✦ UK Assembly
- 📞 Please Call Sales Office

Part Number	Availability	Thread	Function	Symbol	Flow Rate (NI/min)	Operating Pressures (Bar)	
						SoL. DC	SoL. AC
638-150-A6*	✓	1/8	3 way NC	EV03	130	0-10	-
648-150-A6*	✓	1/8	3 way NO	EV05	80	0-8	0-6

*Add voltage coding

Technical Data

Media

Filtered air, inert gas

Operating Temperature

0°C to 60°C (seals in FKM)
-50°C TO +50°C (seals in NBR)

Full Data Sheet and Dimensions at <https://store.camozzi.co.uk>

ACCESSORIES

CONNECTOR	STRAIGHT CONNECTION	ELBOW FITTING
-----------	---------------------	---------------



KA132000B9	6512 6-1/8	6522 6-1/8
KA132000B9	6512 6-1/8	6522 6-1/8

For more connector options, including LED versions please see page 134-137

3/2-way NC solenoid valve

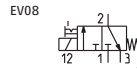

Part Number	Availability	Thread	Function	Symbol	Flow Rate (NI/min)	Operating Pressures (Bar)	
						SoL. DC	SoL. AC
638M-101-A6*	✓	1/8	3 way NC	EV08	120	0-10	0-10
63CM-101-A6*	✓	1/8-Ø4	3 way NC	EV08	108	0-10	0-10

*Add voltage coding

CONNECTOR	STRAIGHT CONNECTION	ELBOW FITTING
-----------	---------------------	---------------



KA132000B9	6512 6-1/8	6522 6-1/8
KA132000B9	6512 6-1/8	6522 6-1/8

For more connector options, including LED versions please see page 134-137

3/2-way NC solenoid valve

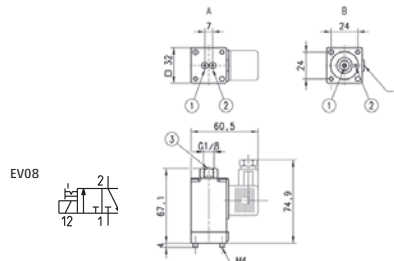

Part Number	Availability	Interface	Function	Symbol	Flow Rate (NI/min)	Operating Pressures (Bar)	
						SoL. DC	SoL. AC
600-450-A6*	✓	Rotatable	3 way interface NC	EV08	106	0-10	0-10
600-457-A6*	✓	Fixed	3 way interface NC	EV08	106	0-10	0-10

*Add voltage coding

CONNECTOR



KA132000B9

KA132000B9

For more connector options, including LED versions please see page 134-137

2/2-way solenoid valves NC, 3/8

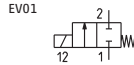

- ✓ Ex Stock
- ✎ UK Assembly
- ☎ Please Call Sales Office

ACCESSORIES

CONNECTOR	STRAIGHT CONNECTION	ELBOW FITTING
-----------	---------------------	---------------



KA132000B9	6512 8-3/8	6522 8-3/8
KA132000B9	6512 8-3/8	6522 8-3/8
KA132000B9	6512 8-3/8	6522 8-3/8

For more connector options, including LED versions please see page 134-137

Part Number	Availability	Thread	Function	Symbol	Flow Rate (NI/min)	Operating Pressures (Bar)	
						Sol. DC	Sol. AC
623-15E-A6*	✓	3/8	2 way NC	EV01	230	0-15	0-15
623-15F-A6*	✓	3/8	2 way NC	EV01	333	0-14	0-14
623-15G-A6*	✓	3/8	2 way NC	EV01	520	0-6	0-6

*Add voltage coding

CODING EXAMPLE

6	3	8	M	-	105	-	A	6	B
----------	----------	----------	----------	----------	------------	----------	----------	----------	----------

6	SERIES: 6	105	TYPE OF DESIGN OF BASE: 150 = threaded body 450 = base with rotatable interface 457 = base with fixed interface 101 = single manifold 102 = 2 - part manifold 103 = 3 - part manifold 104 = 4 - part manifold 105 = 5 - part manifold 106 = 6 - part manifold 107 = 7 - part manifold 108 = 8 - part manifold 109 = 9 - part manifold 110 = 10 - part manifold 111 = 11 - part manifold 112 = 12 - part manifold 113 = 13 - part manifold 114 = 14 - part manifold 115 = 15 - part manifold
3	N° OF CONNECTIONS AND FUNCTIONS: 0 = interface 1 = 2 way NO 2 = 2 way NC 3 = 3 way NC 4 = 3 way NO	A	COIL MATERIALS: A = PPS
8	CONNECTIONS: 0 = Interface 3 = 3/8 8 = 1/8 C = cartridge Ø4	6	SOLENOID DIMENSIONS: 6 = 32 x 32
M	M = Manifold	B	SOLENOID VOLTAGE: B = 24V 50/60 Hz C = 48V 50/60 Hz D = 110V 50/60 Hz E = 220V 50/60 Hz 2 = 12V DC 3 = 24V DC 4 = 48V DC 6 = 110V DC
			VERSIONS: = standard LT = for low temperatures

Technical Data Sheets

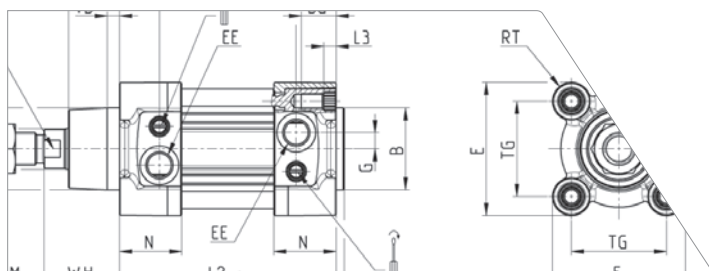

Full technical data sheets available at: <https://store.camozzi.co.uk>

Series E Valves and Solenoid Valves

With outlets on the body
For individual or manifold assembly
10.5mm

The Camozzi range of Series E Valves have been designed to allow high flows with small overall dimensions.

VALVES AND SOLENOID VALVES

5/2-Way Pneumatically actuated valve, monostable - size 10.5

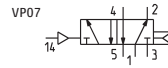

- ✓ Ex Stock
- ✎ UK Assembly
- Ⓞ Please Call Sales Office

Part Number	Availability	Connection	Function	Symbol	Flow Rate (NI/min)	Operating Pressures (Bar)	Minimum Pilot Pressure (Bar)
E521-36	✓	M5	5/2	VP07	200	2.5-7	2.5
E521-C36	Ⓞ	4mm	5/2	VP07	200	2.5-7	2.5

Sub base not included

Technical Data

Media

Filtered air 5 micron or lower, without lubrication. If lubricated air is used, it is recommended to use oil ISO VG32. Once applied, the lubrication should never be interrupted.

Operating Temperature

0°C to +50°C

Full Data Sheet and Dimensions at <https://store.camozzi.co.uk>

ACCESSORIES

STRAIGHT CONNECTION	ELBOW FITTING
6512 4-M5	6522 4-M5
-	-

5/2-Way Electropneumatically actuated valve, monostable - size 10.5

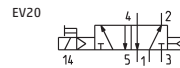

Part Number	Availability	Connection	Function	Symbol	Flow Rate (NI/min)	Operating Pressures (Bar)	Minimum Pilot Pressure (Bar)
E521-16-10-K1*	✓	M5	5/2	EV20	200	2.5-7	2

Sub base not included

CONNECTOR	STRAIGHT CONNECTION	ELBOW FITTING
121-803	6512 4-M5	6522 4-M5

5/2 & 5/3 (CC, CO, PC) Way Pneumatically actuated valve - size 10.5

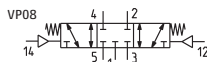

Part Number	Availability	Connection	Function	Symbol	Flow Rate (NI/min)	Operating Pressures (Bar)	Minimum Pilot Pressure (Bar)
E521-33	✓	M5	5/2	VP06	200	-0.9-7	1
E521-C33	Ⓞ	M5	5/2	VP06	200	-0.9-7	1
E621-33	✓	M5	5/3 CC	VP08	200	-0.9-7	2
E621-C33	Ⓞ	M5	5/3 CC	VP08	200	-0.9-7	2
E721-33	Ⓞ	M5	5/3 CO	VP09	200	-0.9-7	2
E721-C33	Ⓞ	M5	5/3 CO	VP09	200	-0.9-7	2
E821-33	Ⓞ	M5	5/3 PC	VP10	200	-0.9-7	2
E821-C33	Ⓞ	M5	5/3 PC	VP10	200	-0.9-7	2

Sub base not included

STRAIGHT CONNECTION	ELBOW FITTING
6512 4-M5	6522 4-M5
6512 4-M5	6522 4-M5
6512 4-M5	6522 4-M5
6512 4-M5	6522 4-M5
6512 4-M5	6522 4-M5
6512 4-M5	6522 4-M5
6512 4-M5	6522 4-M5

5/2 & 5/3 (CC, CO, PC) Electropneumatically actuated valve, bistable - size 10.5



EV24

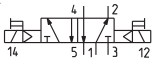

EV27

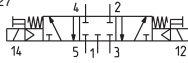

EV31

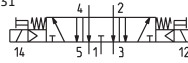

EV35

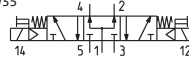

- ✓ Ex Stock
- ✂ UK Assembly
- ☎ Please Call Sales Office

Part Number	Availability	Connection	Function	Symbol	Flow Rate (NI/min)	Operating Pressures (Bar)	Minimum Pilot Pressure (Bar)
E521-11-10-K1*	✓	M5	5/2	EV24	200	1-7	1
E621-11-10-K1*	☎	M5	5/3 CC	EV27	200	2-7	2
E721-11-10-K1*	☎	M5	5/3 CO	EV31	200	2-7	2
E821-11-10-K1*	☎	M5	5/3 PC	EV35	200	2-7	2

Sub base not included

ACCESSORIES

CONNECTOR	STRAIGHT CONNECTION	ELBOW FITTING
-----------	---------------------	---------------



121-803	6512 4-M5	6522 4-M5
121-803	6512 4-M5	6522 4-M5
121-803	6512 4-M5	6522 4-M5
121-803	6512 4-M5	6522 4-M5

CODING EXAMPLE

E	5	2	1	-	11	-	10	-	K	1	3
----------	----------	----------	----------	----------	-----------	----------	-----------	----------	----------	----------	----------

E	SERIES: E	1	BODY TYPE: 1 = body with threaded plate	K	SOLENOID TYPE: K
5	FUNCTION: 5 = 5/2 6 = 5/3 centre closed 7 = 5/3 centre open 8 = 5/3 pressure centre	11	ACTUATION: 11 = electro-pneumatic, bistable 16 = electro-pneumatic, monostable 33 = pneumatic bistable - tube Ø3 36 = pneumatic monostable - tube Ø3 C33 = pneumatic bistable - tube Ø4 C36 = pneumatic monostable - tube Ø4	1	SOLENOID DIMENSIONS: 1 = 10x10
2	SIZE: 2 = Sizes 10.5	10	INTERFACE: 10	3	SOLENOID VOLTAGE: * 1 = 6V DC (on request) 2 = 12V DC (on request) 3 = 24V DC

UK Online Store



Request an account today

- Instantly check price and availability
- Download product datasheets
- Place orders whenever it suits you



Series E Valves and Solenoid Valves

Base mounted body
For individual or manifold assembly
10.5mm

The Camozzi range of Series E Valves have been designed to allow high flows with small overall dimensions.

VALVES AND SOLENOID VALVES

5/2 Way Pneumatically actuated valve, monostable - size 10.5

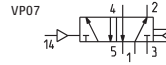

- ✓ Ex Stock
- ✎ UK Assembly
- ☎ Please Call Sales Office

Technical Data

Media

Filtered air 5 micron or lower, without lubrication. If lubricated air is used, it is recommended to use oil ISO VG32. Once applied, the lubrication should never be interrupted.

Operating Temperature

0°C to +50°C

Full Data Sheet and Dimensions at <https://store.camozzi.co.uk>

Part Number	Availability	Function	Symbol	Flow Rate (NI/min)	Operating Pressures (Bar)	Minimum Pilot Pressure (Bar)
E520-36	✓	5/2	VP07	280	2.5-7	2.5
E520-C36	✓	5/2	VP07	280	2.5-7	2.5

Sub base not included

5/2 Way Electropneumatically actuated valve, monostable - size 10.5

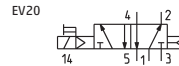
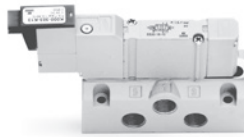

ACCESSORIES

CONNECTOR



Part Number	Availability	Function	Symbol	Flow Rate (NI/min)	Operating Pressures (Bar)	Minimum Pilot Pressure (Bar)
E520-16-10-K1*	✓	5/2	EV20	280	2-7	2

*Add voltage coding. Sub base not included

121-803

5/2 & 5/3 (CC, CO, PC) Way Pneumatically actuated valve - size 10.5

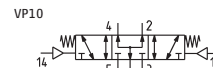
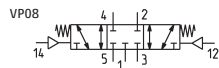
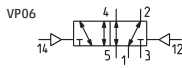

Part Number	Availability	Function	Symbol	Flow Rate (NI/min)	Operating Pressures (Bar)	Minimum Pilot Pressure (Bar)
E520-33	✓	5/2	VP06	280	-0.9-7	1
E520-C33	✓	5/2	VP06	280	-0.9-7	1
E620-33	✓	5/3 CC	VP08	280	-0.9-7	2
E620-C33	✓	5/3 CC	VP08	280	-0.9-7	2
E720-33	✓	5/3 CO	VP09	280	-0.9-7	2
E720-C33	✓	5/3 CO	VP09	280	-0.9-7	2
E820-33	✓	5/3 PC	VP10	280	-0.9-7	2
E820-C33	✓	5/3 PC	VP10	280	-0.9-7	2

Sub base not included

5/2 & 5/3 (CC, CO, PC) Electropneumatically actuated valve - size 10.5

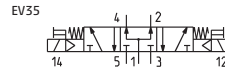
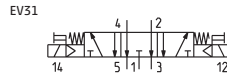
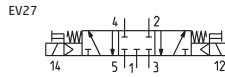
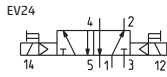

- ✓ Ex Stock
- ✎ UK Assembly
- ☎ Please Call Sales Office

Part Number	Availability	Function	Symbol	Flow Rate (NI/min)	Operating Pressures (Bar)	Minimum Pilot Pressure (Bar)
E520-11-10-K1*	✓	5/2	EV10	280	2-7	2
E620-11-10-K1*	✓	5/3 CC	EV27	280	2-7	2
E720-11-10-K1*	✓	5/3 CO	EV31	280	2-7	2
E820-11-10-K1*	✓	5/3 PC	EV35	280	2-7	2

*Add voltage coding
Sub base not included

ACCESSORIES

Connector



121-803
121-803
121-803
121-803

CODING EXAMPLE

E 5 2 0 - 11 - 10 - K 1 3

E SERIES: E	0 BODY TYPE: 0 = body for sub-base	K SOLENOID TYPE: K = solenoid (10x10)
5 FUNCTION: 5 = 5/2 6 = 5/3 centre closed 7 = 5/3 centre open 8 = 5/3 pressure centre	11 ACTUATION: 11 = electro-pneumatic, bistable 16 = electro-pneumatic, monostable 33 = pneumatic bistable - tube Ø3 36 = pneumatic monostable - tube Ø3 * C33 = pneumatic bistable - tube Ø4 * C36 = pneumatic monostable - tube Ø4 311 = electro-pneumatic bistable on subbase or manifold 316 = electro-pneumatic monostable on subbase or manifold 333 = pneumatic bistable on sub-base or manifold 336 = pneumatic monostable on sub-base or manifold	1 SOLENOID DIMENSIONS: 1 = 10x10
2 SIZE: 2 = Sizes 10.5	10 INTERFACE: 10	3 SOLENOID VOLTAGE: * 1 = 6V DC 3 = 24V DC * 2 = 12V DC

*on request.

Single sub-base for base mounted valves - size 10.5

Connections:1/8



Technical Data

Mountings

By means of screws supplied with valves.

Full Data Sheet and Dimensions at <https://store.camozzi.co.uk>

- ✓ Ex Stock
- ✎ UK Assembly
- ☎ Please Call Sales Office

Part Number	Availability
E520-0101	✓

ACCESSORIES

SILENCER	STRAIGHT CONNECTION	ELBOW FITTING
2901 1/8	6512 6-1/8	6522 6-1/8

Manifolds for valves with outlets on the body Size 10,5

Connections:1/8



Part Number	Availability
E521-10**	✓

**See coding example below for number of postions

BLANKING PLUG	SILENCER	STRAIGHT CONNECTION	ELBOW FITTING
S2610 1/8	2901 1/8	6512 6-1/8	6522 6-1/8

Manifolds for base mounted valves size 10.5

Connections:1/8

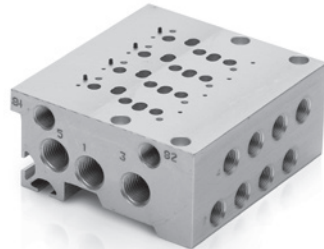

Part Number	Availability
E520-21**	✓
E520-2C**	✓

**See coding example below for number of postions

BLANKING PLUG	SILENCER	STRAIGHT CONNECTION	ELBOW FITTING
S2610 1/8	2901 1/8	6512 6-1/8	6522 6-1/8

CODING EXAMPLE

E5	2	1	-	1	0	04
-----------	----------	----------	----------	----------	----------	-----------

E5	SERIES: E5	1	BODY TYPE: 0 = body for sub-base assembly 1 = body with threads or tube connection	0	CONNECTIONS: 0 = for valves with outlets on the body 1 = threaded C = tube 4 (size 10,5)
2	SIZE: 2 = Size 10.5	1	TYPE OF SUB-BASE: 0 = single sub-base with side outlets 1 = manifold for threaded valve 2 = manifold for body mounted valve	04	Nº OF POSITIONS: 01 = single 03, 04, 06, 08, 10, 12 = multiple

NOTE: When constructing manifolds with 10 or more stations, it is recommended, in order to reduce the risk of pressure drop within the assembly, that pressure is supplied to connection 1 at each end of the block. The exhaust connection 3 and 5 at each end should also be utilized (size 10.5 and 16mm). The same provision should be made for 5 station manifolds of the 19mm valves. Manifolds complete with connections for external pilot supply are available on request.

Series E Accessories for Valves

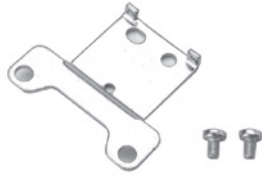

- ✓ Ex Stock
- 🔧 UK Assembly
- ☎ Please Call Sales Office

Part Number	Availability	
B1-E521	✓	for valves size 10.5

Horizontal feet for valves with outlets on the body.



Part Number	Availability	
B2-E521	☎	for valves size 10.5

Vertical feet for valves with outlets on the body (monostable only).



Part Number	Availability	Threaded Valves Size
TP-E521	✓	10.5
TP-E520	✓	10.5

Blanking plate for manifolds.



Part Number	Availability	
PCF-E520	✓	

Suitable for all manifolds

Mounting brackets for DIN rail channel DIN EN 50022 (7.5 x 35 with 1mm).

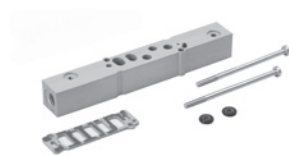

Part Number	Availability	Threaded Valves Size
PCP-E521	✓	10.5
PCP-E520	✓	10.5

Intermediate plate for manifolds for valves with separate supply in 1.



Part Number	Availability	Threaded Valves Size
PCS-E521	☎	10.5
PCS-E520	☎	10.5

Intermediate plate for manifolds for valves with separate supply in 3 and 5.

Series EN Valves and Solenoid Valves

5/2 way, 5/3 way CC - CO - CP

With outlets on the body - For individual or manifold assembly

Size 16 - 19 mm

VALVES AND SOLENOID VALVES

5/2 Way Pneumatically actuated valve, monostable

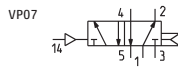

- ✓ Ex Stock
- 🔧 UK Assembly
- 📞 Please Call Sales Office

Part Number	Availability	Thread	Function	Symbol	Flow Rate (NI/min)	Operating Pressures (Bar)	Minimum Pilot Pressures (Bar)
EN531-36	✓	1/8	5/2	VP07	550	-0.9-10	2.5
EN551-36	✓	1/4	5/2	VP07	920	-0.9-10	2.5

Technical Data

Media

Filtered air, without lubrication. If lubricated air is used, it is recommended to use oil ISO VG32. Once applied, the lubrication should never be interrupted.

Operating Temperature

0°C to +50°C.

Full Data Sheet and Dimensions at <https://store.camozzi.co.uk>

ACCESSORIES

STRAIGHT CONNECTION	ELBOW FITTING	PILOT PORT
---------------------	---------------	------------



6512 6-1/8	6522 6-1/8	6512 4-M5
6512 6-1/4	6522 6-1/4	6512 4-M5

5/2 Way Pneumatically actuated valve, bistable

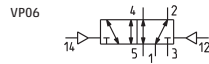

Part Number	Availability	Threads	Function	Symbol	Flow Rate (NI/min)	Operating Pressures (Bar)	Minimum Pilot Pressures (Bar)
EN531-33	✓	1/8	5/2	VP06	550	-0.9-10	2
EN551-33	✓	1/4	5/2	VP06	920	-0.9-10	2

STRAIGHT CONNECTION	ELBOW FITTING	PILOT PORT
---------------------	---------------	------------



6512 6-1/8	6522 6-1/8	6512 4-M5x2
6512 8-1/4	6522 8-1/4	6512 4-M5x2

5/3 Way (CC,CO,PC) Pneumatically actuated valve

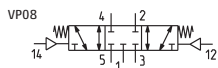

Part Number	Availability	Threads	Function	Symbol	Flow Rate (NI/min)	Operating Pressures (Bar)	Minimum Pilot Pressures (Bar)
EN631-33	✓	1/8	5/3 CC	VP08	550	-0.9-10	3
EN651-33	✓	1/4	5/3 CC	VP08	920	-0.9-10	3
EN731-33	✓	1/8	5/3 CO	VP09	550	-0.9-10	3
EN751-33	✓	1/4	5/3 CO	VP09	920	-0.9-10	3
EN831-33	✓	1/8	5/3 PC	VP10	550	-0.9-10	3
EN851-33	✓	1/4	5/3 PC	VP10	920	-0.9-10	3

STRAIGHT CONNECTION	ELBOW FITTING	PILOT PORT
---------------------	---------------	------------



6512 6-1/8	6522 6-1/8	6512 4-M5x2
6512 8-1/4	6522 8-1/4	6512 4-M5x2
6512 6-1/8	6522 6-1/8	6512 4-M5x2
6512 8-1/4	6522 8-1/4	6512 4-M5x2
6512 6-1/8	6522 6-1/8	6512 4-M5x2
6512 8-1/4	6522 8-1/4	6512 4-M5x2

5/2 Way Electro-pneumatically actuated valve, monostable

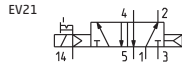

- ✓ Ex Stock
- ✎ UK Assembly
- ⦿ Please Call Sales Office

Part Number	Availability	Threads	Function	Symbol	Flow Rate (NI/min)	Operating Pressures (Bar)	Minimum Pilot Pressures (Bar)
EN531-16-P*	✓	1/8	5/2	EV21	550	2.5-10	-
EN551-16-P*	✓	1/4	5/2	EV21	920	2.5-10	-
EN531-16-W*	✓	1/8	5/2	EV21	550	2.5-10	-
EN551-16-W*	✓	1/4	5/2	EV21	920	2.5-10	-

*Add voltage coding

ACCESSORIES

CONNECTOR	STRAIGHT CONNECTION	ELBOW FITTING
-----------	---------------------	---------------



KD136000B7	6512 6-1/8	6522 6-1/8
KD136000B7	6512 8-1/4	6522 8-1/4
KD136000B7	6512 6-1/8	6522 6-1/8
KD136000B7	6512 8-1/4	6522 8-1/4

For more connector options, including LED versions please see page 134-137

5/2 Way Electro-pneum. valve, monostable - ext. servo-pilot supply

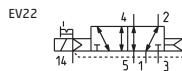

Part Number	Availability	Threads	Function	Symbol	Flow Rate (NI/min)	Operating Pressures (Bar)	Minimum Pilot Pressures (Bar)
EN531-E16-P*	✓	1/8	5/2	EV22	550	-0.9-10	2.5
EN551-E16-P*	✓	1/4	5/2	EV22	920	-0.9-10	2.5
EN531-E16-W*	✓	1/8	5/2	EV22	550	-0.9-10	2.5
EN551-E16-W*	✓	1/4	5/2	EV22	920	-0.9-10	2.5

*Add voltage coding

CONNECTOR	STRAIGHT CONNECTION	ELBOW FITTING
-----------	---------------------	---------------



KD136000B7	6512 6-1/8	6522 6-1/8
KD136000B7	6512 8-1/4	6522 8-1/4
KD136000B7	6512 6-1/8	6522 6-1/8
KD136000B7	6512 8-1/4	6522 8-1/4

For more connector options, including LED versions please see page 134-137

5/2 Way Electro-pneumatically actuated valve, bistable

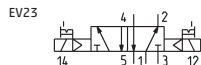

Part Number	Availability	Threads	Function	Symbol	Flow Rate (NI/min)	Operating Pressures (Bar)	Minimum Pilot Pressures (Bar)
EN531-11-P*	✓	1/8	5/2	EV23	550	2-10	-
EN551-11-P*	✓	1/4	5/2	EV23	920	2-10	-
EN531-11-W*	✓	1/8	5/2	EV23	550	2-10	-
EN551-11-W*	✓	1/4	5/2	EV23	920	2-10	-

*Add voltage coding

CONNECTOR	STRAIGHT CONNECTION	ELBOW FITTING
-----------	---------------------	---------------



KD136000B7	6512 6-1/8	6522 6-1/8
KD136000B7	6512 8-1/4	6522 8-1/4
KD136000B7	6512 6-1/8	6522 6-1/8
KD136000B7	6512 8-1/4	6522 8-1/4

For more connector options, including LED versions please see page 134-137

5/2 Way Electro-pneumatically actuated valve, bistable ext. servo-pilot supply

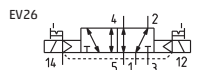

Part Number	Availability	Threads	Function	Symbol	Flow Rate (NI/min)	Operating Pressures (Bar)	Minimum Pilot Pressures (Bar)
EN531-E11-P*	✓	1/8	5/2	EV26	550	-0.9-10	2
EN551-E11-P*	✓	1/4	5/2	EV26	920	-0.9-10	2
EN531-E11-W*	✓	1/8	5/2	EV26	550	-0.9-10	2
EN551-E11-W*	✓	1/4	5/2	EV26	920	-0.9-10	2

*Add voltage coding

CONNECTOR	STRAIGHT CONNECTION	ELBOW FITTING
-----------	---------------------	---------------



KD136000B7	6512 6-1/8	6522 6-1/8
KD136000B7	6512 8-1/4	6522 8-1/4
KD136000B7	6512 6-1/8	6522 6-1/8
KD136000B7	6512 8-1/4	6522 8-1/4

For more connector options, including LED versions please see page 134-137

5/2 Way Electro-pneumatically actuated valve, monostable

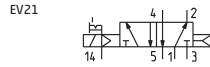

- ✓ Ex Stock
- ✎ UK Assembly
- ☎ Please Call Sales Office

Part Number	Availability	Threads	Function	Symbol	Flow Rate (NI/min)	Operating Pressures (Bar)	Minimum Pilot Pressures (Bar)
EN531-16-PN*	✓	1/8	5/2	EV21	550	2.5-10	-
EN551-16-PN*	✓	1/4	5/2	EV21	920	2.5-10	-

*Add voltage coding

ACCESSORIES

CONNECTOR	STRAIGHT CONNECTION	ELBOW FITTING
-----------	---------------------	---------------



KD136000B7	6512 6-1/8	6522 6-1/8
KD136000B7	6512 8-1/4	6522 8-1/4

For more connector options, including LED versions please see page 134-137

5/2 Way Electro-pneum. valve, monostable - ext. servo-pilot supply

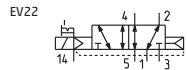

Part Number	Availability	Threads	Function	Symbol	Flow Rate (NI/min)	Operating Pressures (Bar)	Minimum Pilot Pressures (Bar)
EN531-E16-PN*	✓	1/8	5/2	EV22	550	-0.9-10	2.5
EN551-E16-PN*	✓	1/4	5/2	EV22	920	-0.9-10	2.5

*Add voltage coding

CONNECTOR	STRAIGHT CONNECTION	ELBOW FITTING
-----------	---------------------	---------------



KD136000B7	6512 6-1/8	6522 6-1/8
KD136000B7	6512 8-1/4	6522 8-1/4

For more connector options, including LED versions please see page 134-137

5/2 Way Electro-pneumatically actuated valve, bistable

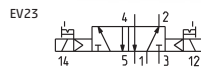

Part Number	Availability	Threads	Function	Symbol	Flow Rate (NI/min)	Operating Pressures (Bar)	Minimum Pilot Pressures (Bar)
EN531-11-PN*	✓	1/8	5/2	EV23	550	2-10	-
EN551-11-PN*	✓	1/4	5/2	EV23	920	2-10	-

*Add voltage coding

CONNECTOR	STRAIGHT CONNECTION	ELBOW FITTING
-----------	---------------------	---------------



KD136000B7	6512 6-1/8	6522 6-1/8
KD136000B7	6512 8-1/4	6522 8-1/4

For more connector options, including LED versions please see page 134-137

5/2 Way Electro-pneum. valve, bistable - ext. servo-pilot supply

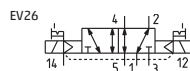

Part Number	Availability	Threads	Function	Symbol	Flow Rate (NI/min)	Operating Pressures (Bar)	Minimum Pilot Pressures (Bar)
EN531-E11-PN*	✓	1/8	5/2	EV26	550	-0.9-10	-
EN551-E11-PN*	✓	1/4	5/2	EV26	920	-0.9-10	-

*Add voltage coding

CONNECTOR	STRAIGHT CONNECTION	ELBOW FITTING
-----------	---------------------	---------------



KD136000B7	6512 6-1/8	6522 6-1/8
KD136000B7	6512 8-1/4	6522 8-1/4

For more connector options, including LED versions please see page 134-137

5/3 Way (CC,CO,PC) Electro-pneumatic Valve, Solenoid P, W - Size 16 & 19

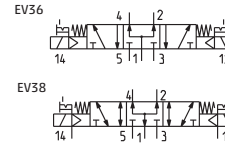
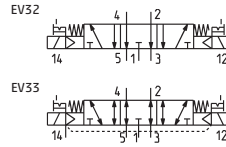
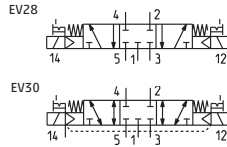

- ✓ Ex Stock
- 🔧 UK Assembly
- ☎ Please Call Sales Office

ACCESSORIES

CONNECTOR	STRAIGHT CONNECTION	ELBOW FITTING
-----------	---------------------	---------------



Part Number	Availability	Threads	Function	Symbol	Flow Rate (NI/min)	Operating Pressures (Bar)	Minimum Pilot Pressures (Bar)	CONNECTOR	STRAIGHT CONNECTION	ELBOW FITTING
EN631-11-P*	✓	1/8	5/3 CC	EV28	550	3-10	-	KD136000B7	6512 6-1/8	6522 6-1/8
EN651-11-P*	✓	1/4	5/3 CC	EV28	920	3-10	-	KD136000B7	6512 8-1/4	6522 8-1/4
EN631-11-W*	✓	1/8	5/3 CC	EV28	550	3-10	-	KD136000B7	6512 6-1/8	6522 6-1/8
EN651-11-W*	✓	1/4	5/3 CC	EV28	920	3-10	-	KD136000B7	6512 8-1/4	6522 8-1/4
EN731-11-P*	✓	1/8	5/3 CO	EV32	550	3-10	-	KD136000B7	6512 6-1/8	6522 6-1/8
EN751-11-P*	✓	1/4	5/3 CO	EV32	920	3-10	-	KD136000B7	6512 8-1/4	6522 8-1/4
EN731-11-W*	✓	1/8	5/3 CO	EV32	550	3-10	-	KD136000B7	6512 6-1/8	6522 6-1/8
EN751-11-W*	✓	1/4	5/3 CO	EV32	920	3-10	-	KD136000B7	6512 8-1/4	6522 8-1/4
EN831-11-P*	✓	1/8	5/3 PC	EV36	550	3-10	-	KD136000B7	6512 6-1/8	6522 6-1/8
EN851-11-P*	✓	1/4	5/3 PC	EV36	920	3-10	-	KD136000B7	6512 8-1/4	6522 8-1/4
EN831-11-W*	✓	1/8	5/3 PC	EV36	550	3-10	-	KD136000B7	6512 6-1/8	6522 6-1/8
EN851-11-W*	✓	1/4	5/3 PC	EV36	920	3-10	-	KD136000B7	6512 8-1/4	6522 8-1/4
EN631-E11-P*	✓	1/8	5/3 CC	EV30	550	-0.9-10	3	KD136000B7	6512 6-1/8	6522 6-1/8
EN651-E11-P*	✓	1/4	5/3 CC	EV30	920	-0.9-10	3	KD136000B7	6512 8-1/4	6522 8-1/4
EN631-E11-W*	✓	1/8	5/3 CC	EV30	550	-0.9-10	3	KD136000B7	6512 6-1/8	6522 6-1/8
EN651-E11-W*	✓	1/4	5/3 CC	EV30	920	-0.9-10	3	KD136000B7	6512 8-1/4	6522 8-1/4
EN731-E11-P*	✓	1/8	5/3 CO	EV33	550	-0.9-10	3	KD136000B7	6512 6-1/8	6522 6-1/8
EN751-E11-P*	✓	1/4	5/3 CO	EV33	920	-0.9-10	3	KD136000B7	6512 8-1/4	6522 8-1/4
EN731-E11-W*	✓	1/8	5/3 CO	EV33	550	-0.9-10	3	KD136000B7	6512 6-1/8	6522 6-1/8
EN751-E11-W*	✓	1/4	5/3 CO	EV33	920	-0.9-10	3	KD136000B7	6512 8-1/4	6522 8-1/4
EN831-E11-P*	✓	1/8	5/3 PC	EV38	550	-0.9-10	3	KD136000B7	6512 6-1/8	6522 6-1/8
EN851-E11-P*	✓	1/4	5/3 PC	EV38	920	-0.9-10	3	KD136000B7	6512 8-1/4	6522 8-1/4
EN831-E11-W*	✓	1/8	5/3 PC	EV38	550	-0.9-10	3	KD136000B7	6512 6-1/8	6522 6-1/8
EN851-E11-W*	✓	1/4	5/3 PC	EV38	920	-0.9-10	3	KD136000B7	6512 8-1/4	6522 8-1/4

*Add voltage coding

For more connector options, including LED versions please see page 134-137

5/3 Way (CC,CO,PC) Electro-pneumatically Actuated Valve - Size 16 & 19

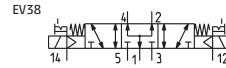
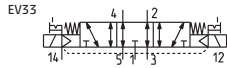
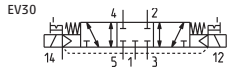
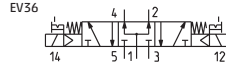
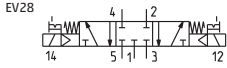

- ✓ Ex Stock
- 🔧 UK Assembly
- ☎ Please Call Sales Office

Part Number	Availability	Threads	Function	Symbol	Flow Rate (NI/min)	Operating Pressures (Bar)	Minimum Pilot Pressures (Bar)
EN631-11-PN*	✓	1/8	5/3 CC	EV28	550	3-10	-
EN651-11-PN*	✓	1/4	5/3 CC	EV28	920	3-10	-
EN731-11-PN*	✓	1/8	5/3 CO	EV32	550	3-10	-
EN751-11-PN*	✓	1/4	5/3 CO	EV32	920	3-10	-
EN831-11-PN*	✓	1/8	5/3 PC	EV36	550	3-10	-
EN851-11-PN*	✓	1/4	5/3 PC	EV36	920	3-10	-
EN631-E11-PN*	✓	1/8	5/3 CC	EV30	550	-0.9-10	3
EN651-E11-PN*	✓	1/4	5/3 CC	EV30	920	-0.9-10	3
EN731-E11-PN*	✓	1/8	5/3 CO	EV33	550	-0.9-10	3
EN751-E11-PN*	✓	1/4	5/3 CO	EV33	920	-0.9-10	3
EN831-E11-PN*	✓	1/8	5/3 PC	EV38	550	-0.9-10	3
EN851-E11-PN*	✓	1/4	5/3 PC	EV38	920	-0.9-10	3

*Add voltage coding

ACCESSORIES

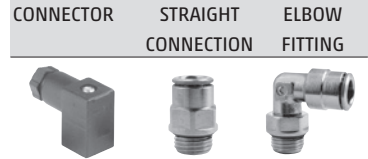

CONNECTOR	STRAIGHT CONNECTION	ELBOW FITTING
KD136000B7	6512 6-1/8	6522 6-1/8
KD136000B7	6512 8-1/4	6522 8-1/4
KD136000B7	6512 6-1/8	6522 6-1/8
KD136000B7	6512 8-1/4	6522 8-1/4
KD136000B7	6512 6-1/8	6522 6-1/8
KD136000B7	6512 8-1/4	6522 8-1/4
KD136000B7	6512 6-1/8	6522 6-1/8
KD136000B7	6512 8-1/4	6522 8-1/4
KD136000B7	6512 6-1/8	6522 6-1/8
KD136000B7	6512 8-1/4	6522 8-1/4

For more connector options, including LED versions please see page 134-137

CODING EXAMPLE

EN	5	3	1	-	11	-	PN3
EN SERIES: EN		3 SIZES: 3 = 16mm 5 = 19mm			11 ACTUATION: 11 = electro-pneumatic, bistable 16 = electro-pneumatic, monostable 33 = pneumatic bistable 36 = pneumatic monostable		E11 = electro-pneumatic, bistable with external servo-pilot supply E16 = electro-pneumatic, monostable with external servo-pilot supply
5 FUNCTION 5 = 5/2 6 = 5/3 Centre Closed 7 = 5/3 Centre Open 8 = 5/3 Pressure Centre		1 BODY TYPE: 1 = body with threaded plate			PN3 TYPE OF SOLENOID PN3 = 24V DC - 1W PN4 = 48V DC - 2W PN6 = 110V DC - 2W PN7 = 230V - 2W		P13 = 24V DC - 1W P54 = 48V DC - 2W P56 = 110V DC - 2W W53 = 24V DC - 2W W54 = 48V DC - 2W
In case of applications with alternate current, use a bridge rectifier connector							

Series EN Valves and Solenoid Valves

5/2 way, 5/3 way CC - CO - CP

For manifold assembly

Size 16 - 19 mm

5/2 Way Monostable pneumatic valve with outlets on sub-base

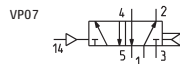

- ✓ Ex Stock
- ✂ UK Assembly
- 📞 Please Call Sales Office

Part Number	Availability	Function	Symbol	Flow Rate (NI/min)	Operating Pressures (Bar)	Minimum Pilot Pressures (Bar)
EN530-36	✓	5/2	VP07	610	2.5-10	2.5
EN550-36	✓	5/2	VP07	1000	2-10	2.5

Technical Data

Media

Filtered air, without lubrication. If lubricated air is used, it is recommended to use oil ISO VG32. Once applied, the lubrication should never be interrupted.

Operating Temperature

0°C to +50°C.

Full Data Sheet and Dimensions at <https://store.camozzi.co.uk>

ACCESSORIES

PILOT
PORT



6512 4-M5

6512 4-M5

5/2 Way Bistable pneumatic valve with outlets on sub-base

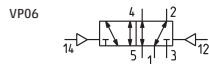

Part Number	Availability	Function	Symbol	Flow Rate (NI/min)	Operating Pressures (Bar)	Minimum Pilot Pressures (Bar)
EN530-33	✓	5/2	VP06	610	-0.9-10	2
EN550-33	✓	5/2	VP06	1000	-0.9-10	2

PILOT
PORT



6512 4-M5 x2

6512 4-M5 x2

5/3 Way (CC,CO,PC) Pneumatically actuated valve with outlets on sub-base

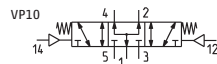
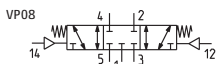

Part Number	Availability	Function	Symbol	Flow Rate (NI/min)	Operating Pressures (Bar)	Minimum Pilot Pressures (Bar)
EN630-33	✓	5/3 CC	VP08	610	-0.9-10	3
EN650-33	✓	5/3 CC	VP08	1000	-0.9-10	3
EN730-33	✓	5/3 CO	VP09	610	-0.9-10	3
EN750-33	✓	5/3 CO	VP09	1000	-0.9-10	3
EN830-33	✓	5/3 PC	VP10	610	-0.9-10	3
EN850-33	✓	5/3 PC	VP10	1000	-0.9-10	3

PILOT
PORT



6512 4-M5 x2

6512 4-M5 x2

6512 4-M5 x2

6512 4-M5 x2

6512 4-M5 x2

6512 4-M5 x2

5/2 Way Electropneumatic valve, monostable with outlets on sub-base

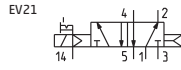

- ✓ Ex Stock
- ✎ UK Assembly
- ☎ Please Call Sales Office

Part Number	Availability	Function	Symbol	Flow Rate (NI/min)	Operating Pressures (Bar)	Minimum Pilot Pressures (Bar)
EN530-16-P*	✓	5/2	EV21	610	2.5-10	-
EN550-16-P*	✓	5/2	EV21	1000	2.5-10	-
EN530-16-W*	✓	5/2	EV21	610	2.5-10	-
EN550-16-W*	✓	5/2	EV21	1000	2.5-10	-

*Add voltage coding

ACCESSORIES

CONNECTOR



KD136000B7

KD136000B7

KD136000B7

KD136000B7

For more connector options, including LED versions please see page 134-137

5/2 Way Electropneumatic valve, monostable with outlets on sub-base

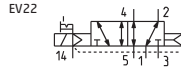
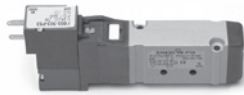

Part Number	Availability	Function	Symbol	Flow Rate (NI/min)	Operating Pressures (Bar)	Minimum Pilot Pressures (Bar)
EN530-E16-P*	✓	5/2	EV22	610	-0.9-10	2.5
EN550-E16-P*	✓	5/2	EV22	1000	-0.9-10	2
EN530-E16-W*	✓	5/2	EV22	610	-0.9-10	2.5
EN550-E16-W*	✓	5/2	EV22	1000	-0.9-10	2

*Add voltage coding

CONNECTOR



KD136000B7

KD136000B7

KD136000B7

KD136000B7

For more connector options, including LED versions please see page 134-137

5/2 Way Electropneumatic valve, bistable with outlets on sub-base

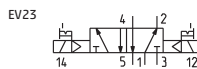

Part Number	Availability	Function	Symbol	Flow Rate (NI/min)	Operating Pressures (Bar)	Minimum Pilot Pressures (Bar)
EN530-11-P*	✓	5/2	EV23	610	2-10	-
EN550-11-P*	✓	5/2	EV23	1000	2-10	-
EN530-11-W*	✓	5/2	EV23	610	2-10	-
EN550-11-W*	✓	5/2	EV23	1000	2-10	-

*Add voltage coding

CONNECTOR



KD136000B7 x2

KD136000B7 x2

KD136000B7 x2

KD136000B7 x2

For more connector options, including LED versions please see page 134-137

5/2 Way Electro-pn. bistable valve, ext. pilot supply, outlets on sub-base

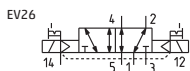

Part Number	Availability	Function	Symbol	Flow Rate (NI/min)	Operating Pressures (Bar)	Minimum Pilot Pressures (Bar)
EN530-E11-P*	✓	5/2	EV26	610	-0.9-10	2
EN550-E11-P*	✓	5/2	EV26	1000	-0.9-10	2
EN530-E11-W*	✓	5/2	EV26	610	-0.9-10	2
EN550-E11-W*	✓	5/2	EV26	1000	-0.9-10	2

*Add voltage coding

CONNECTOR



KD136000B7 x2

KD136000B7 x2

KD136000B7 x2

KD136000B7 x2

For more connector options, including LED versions please see page 134-137

5/2 Way Electropneumatic valve, monostable with outlets on sub-base

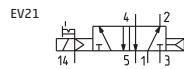

- ✓ Ex Stock
- ✈ UK Assembly
- ☎ Please Call Sales Office

Part Number	Availability	Function	Symbol	Flow Rate (NI/min)	Operating Pressures (Bar)	Minimum Pilot Pressures (Bar)
EN530-16-PN*	✓	5/2	EV21	610	2.5-10	-
EN550-16-PN*	✓	5/2	EV21	1000	2.5-10	-

*Add voltage coding

ACCESSORIES

CONNECTOR



KD136000B7

KD136000B7

For more connector options, including LED versions please see page 134-137

5/2 Way Electro-pn. monost. valve, ext. pilot supply, outlets on sub-base

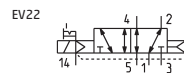

Part Number	Availability	Function	Symbol	Flow Rate (NI/min)	Operating Pressures (Bar)	Minimum Pilot Pressures (Bar)
EN530-E16-PN*	✓	5/2	EV22	610	-0.9-10	2.5
EN550-E16-PN*	✓	5/2	EV22	1000	-0.9-10	2.5

*Add voltage coding

CONNECTOR



KD136000B7

KD136000B7

For more connector options, including LED versions please see page 134-137

5/2 Way Electropneumatic valve. bistable with outlets on sub-base

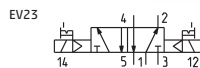

Part Number	Availability	Function	Symbol	Flow Rate (NI/min)	Operating Pressures (Bar)	Minimum Pilot Pressures (Bar)
EN530-11-PN*	✓	5/2	EV23	610	2-10	-
EN550-11-PN*	✓	5/2	EV23	1000	2-10	-

*Add voltage coding

CONNECTOR



KD136000B7 x2

KD136000B7 x2

For more connector options, including LED versions please see page 134-137

5/2 Way Electro-pn. bistable valve, ext. pilot supply, outlets on sub-base

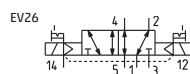

Part Number	Availability	Function	Symbol	Flow Rate (NI/min)	Operating Pressures (Bar)	Minimum Pilot Pressures (Bar)
EN530-E11-PN*	✓	5/2	EV26	610	-0.9-10	2
EN550-E11-PN*	✓	5/2	EV26	1000	-0.9-10	3

*Add voltage coding

CONNECTOR



KD136000B7 x2

KD136000B7 x2

For more connector options, including LED versions please see page 134-137

5/3 Way (CC,CO,PC) Electro-pneumatic valve, sol. P / W, outlets on sub-base

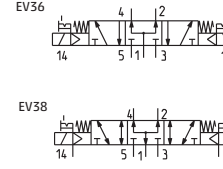
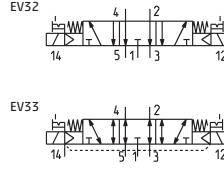
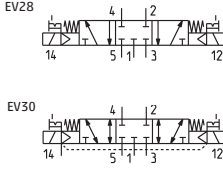

VALVES AND SOLENOID VALVES

- ✓ Ex Stock
- ✎ UK Assembly
- ☎ Please Call Sales Office

Part Number	Availability	Function	Symbol	Flow Rate (NI/min)	Operating Pressures (Bar)	Minimum Pilot Pressures (Bar)
EN630-11-P*	✓	5/3 CC	EV28	610	3-10	-
EN650-11-P*	✓	5/3 CC	EV28	1000	3-10	-
EN630-11-W*	✓	5/3 CC	EV28	610	3-10	-
EN650-11-W*	✓	5/3 CC	EV28	1000	3-10	-
EN730-11-P*	✓	5/3 CO	EV32	610	3-10	-
EN750-11-P*	✓	5/3 CO	EV32	1000	3-10	-
EN730-11-W*	✓	5/3 CO	EV32	610	3-10	-
EN750-11-W*	✓	5/3 CO	EV32	1000	3-10	-
EN830-11-P*	✓	5/3 PC	EV36	610	3-10	-
EN850-11-P*	✓	5/3 PC	EV36	1000	3-10	-
EN830-11-W*	✓	5/3 PC	EV36	610	3-10	-
EN850-11-W*	✓	5/3 PC	EV36	1000	3-10	-
EN630-E11-P*	✓	5/3 CC	EV30	610	-0.9-10	3
EN650-E11-P*	✓	5/3 CC	EV30	1000	-0.9-10	3
EN630-E11-W*	✓	5/3 CC	EV30	610	-0.9-10	3
EN650-E11-W*	✓	5/3 CC	EV30	1000	-0.9-10	3
EN730-E11-P*	✓	5/3 CO	EV33	610	-0.9-10	3
EN750-E11-P*	✓	5/3 CO	EV33	1000	-0.9-10	3
EN730-E11-W*	✓	5/3 CO	EV33	610	-0.9-10	3
EN750-E11-W*	✓	5/3 CO	EV33	1000	-0.9-10	3
EN830-E11-P*	✓	5/3 PC	EV38	610	-0.9-10	3
EN850-E11-P*	✓	5/3 PC	EV38	1000	-0.9-10	3
EN830-E11-W*	✓	5/3 PC	EV38	610	-0.9-10	3
EN850-E11-W*	✓	5/3 PC	EV38	1000	-0.9-10	3

*Add voltage coding

ACCESSORIES

CONNECTOR



KD136000B7 x2

KD136000B7 x2

KD136000B7 x2

KD136000B7 x2

KD136000B7 x2

KD136000B7 x2

KD136000B7 x2

KD136000B7 x2

KD136000B7 x2

KD136000B7 x2

KD136000B7 x2

KD136000B7 x2

KD136000B7 x2

KD136000B7 x2

KD136000B7 x2

KD136000B7 x2

KD136000B7 x2

KD136000B7 x2

KD136000B7 x2

KD136000B7 x2

KD136000B7 x2

KD136000B7 x2

KD136000B7 x2

KD136000B7 x2

For more connector options, including LED versions please see page 134-137

5/3 Way (CC,CO,PC) Electropneumtical valve with outlets on sub-base

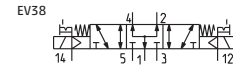
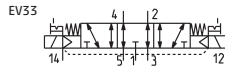
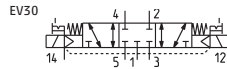
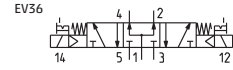
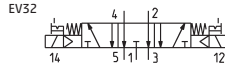
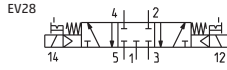

- ✓ Ex Stock
- ✎ UK Assembly
- ☎ Please Call Sales Office

Part Number	Availability	Function	Symbol	Flow Rate (NI/min)	Operating Pressures (Bar)	Minimum Pilot Pressures (Bar)
EN630-11-PN*	✓	5/3 CC	EV28	610	3-10	-
EN650-11-PN*	✓	5/3 CC	EV28	1000	3-10	-
EN730-11-PN*	✓	5/3 CO	EV32	610	3-10	-
EN750-11-PN*	✓	5/3 CO	EV32	1000	3-10	-
EN830-11-PN*	✓	5/3 PC	EV36	610	3-10	-
EN850-11-PN*	✓	5/3 PC	EV36	1000	3-10	-
EN630-E11-PN*	✓	5/3 CC	EV30	610	-0.9-10	3
EN650-E11-PN*	✓	5/3 CC	EV30	1000	-0.9-10	3
EN730-E11-PN*	✓	5/3 CO	EV33	610	-0.9-10	3
EN750-E11-PN*	✓	5/3 CO	EV33	1000	-0.9-10	3
EN830-E11-PN*	✓	5/3 PC	EV38	610	-0.9-10	3
EN850-E11-PN*	✓	5/3 PC	EV38	1000	-0.9-10	3

*Add voltage coding

ACCESSORIES

CONNECTOR



KD136000B7 x2

KD136000B7 x2

KD136000B7 x2

KD136000B7 x2

KD136000B7 x2

KD136000B7 x2

KD136000B7 x2

KD136000B7 x2

KD136000B7 x2

KD136000B7 x2

KD136000B7 x2

KD136000B7 x2

For more connector options, including LED versions please see page 134-137

CODING EXAMPLE

EN	5	3	0	-	11	-	PN3
EN SERIES: EN		3 SIZES: 3 = 16mm 5 = 19mm			11 ACTUATION: 11 = electro-pneumatic, bistable 16 = electro-pneumatic, monostable 33 = pneumatic bistable 36 = pneumatic monostable		E11 = electro-pneumatic, bistable with external servo-pilot supply E16 = electro-pneumatic, monostable with external servo-pilot supply
5 FUNCTION 5 = 5/2 6 = 5/3 Centre Closed 7 = 5/3 Centre Open 8 = 5/3 Pressure Centre		0 BODY TYPE: 0 = body for sub-base			PN3 TYPE OF SOLENOID PN3 = 24V DC - 1W PN4 = 48V DC - 2W PN6 = 110V DC - 2W PN7 = 230V - 2W		P13 = 24V DC - 1W P54 = 48V DC - 2W P56 = 110V DC - 2W W53 = 24V DC - 2W W54 = 48V DC - 2W
In case of applications with alternate current, use a bridge rectifier connector							



Series EN Accessories



- ✓ Ex Stock
- ✎ UK Assembly
- ☎ Please Call Sales Office

Part Number	Availability	Number of Positions
Sub-base (with outlets on the body) Size 16		
EN531-1002	✓	2
EN531-1003	☎	3
EN531-1004	✓	4
EN531-1005	☎	5
EN531-1006	✓	6
EN531-1008	☎	8
EN531-1010	☎	10
EN531-1012	☎	12
Sub-base (with outlets on the body) Size 19		
EN551-1002	✓	2
EN551-1003	☎	3
EN551-1004	✓	4
EN551-1005	☎	5
EN551-1006	✓	6
EN551-1008	☎	8
EN551-1010	☎	10
EN551-1012	☎	12
Manifold (with outlets on the manifold) Size 16		
EN530-2102	✓	2
EN530-2103	☎	3
EN530-2104	✓	4
EN530-2105	☎	5
EN530-2106	✓	6
EN530-2108	☎	8
EN530-2110	☎	10
EN530-2112	☎	12
Manifold (with outlets on the manifold) Size 19		
EN550-2102	✓	2
EN550-2103	☎	3
EN550-2104	✓	4
EN550-2105	☎	5
EN550-2106	✓	6
EN550-2108	☎	8
EN550-2110	☎	10
EN550-2112	☎	12

ACCESSORIES

INLET FITTING	SILENCER	BLANKING PLUG
		
S6510 6-1/8	2901 1/8	S2610 1/8
S6510 6-1/8	2901 1/8	S2610 1/8
S6510 6-1/8	2901 1/8	S2610 1/8
S6510 6-1/8	2901 1/8	S2610 1/8
S6510 6-1/8	2901 1/8	S2610 1/8
S6510 6-1/8	2901 1/8	S2610 1/8
S6510 6-1/8	2901 1/8	S2610 1/8
S6510 6-1/8	2901 1/8	S2610 1/8
S6510 8-1/4	2901 1/4-17	S2610 1/4
S6510 8-1/4	2901 1/4-17	S2610 1/4
S6510 8-1/4	2901 1/4-17	S2610 1/4
S6510 8-1/4	2901 1/4-17	S2610 1/4
S6510 8-1/4	2901 1/4-17	S2610 1/4
S6510 8-1/4	2901 1/4-17	S2610 1/4
S6510 8-1/4	2901 1/4-17	S2610 1/4
S6510 8-1/4	2901 1/4-17	S2610 1/4
S6510 6-1/8	2901 1/8	S2610 1/8
S6510 6-1/8	2901 1/8	S2610 1/8
S6510 6-1/8	2901 1/8	S2610 1/8
S6510 6-1/8	2901 1/8	S2610 1/8
S6510 6-1/8	2901 1/8	S2610 1/8
S6510 6-1/8	2901 1/8	S2610 1/8
S6510 6-1/8	2901 1/8	S2610 1/8
S6510 8-1/4	2901 1/4-17	S2610 1/4
S6510 8-1/4	2901 1/4-17	S2610 1/4
S6510 8-1/4	2901 1/4-17	S2610 1/4
S6510 8-1/4	2901 1/4-17	S2610 1/4
S6510 8-1/4	2901 1/4-17	S2610 1/4
S6510 8-1/4	2901 1/4-17	S2610 1/4
S6510 8-1/4	2901 1/4-17	S2610 1/4
S6510 8-1/4	2901 1/4-17	S2610 1/4

Series EN Accessories

- ✓ Ex Stock
- 🇬🇧 UK Assembly
- 📞 Please Call Sales Office



**Blanking plate for manifolds
(with outlets on the body)**

Part Number	Availability	Size
TP-EN531	✓	16
TP-EN551	✓	19



**Blanking plate for manifolds
(base mounted valves)**

Part Number	Availability	Size
TP-EN530	✓	16
TP-EN550	✓	19



**Connectors 24DC PN with led for
solenoid P and PN**

Part Number	Availability	Cable Length
125-503-2	📞	2m
125-503-5	📞	



**Conn. V-AC PN with bridge rectifier for
solenoid P and PN**

Part Number	Availability	Cable Length
125-903-2	📞	2m
125-903-5	📞	5m



**In-line connectors
with cable**

Part Number	Availability	Cable Length
125-553-2	📞	2m
125-553-5	📞	5m

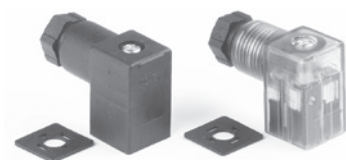

Connectors DIN 43650

Part Number	Availability	Description
KD136000B7	✓	Black Connector PG7 9.4mm Pin Spacing
KC136000B7	✓	Black Connector PG7 8mm Pin Spacing

**Mounting brackets for DIN rail
DIN EN 50022 (7.5mm x 35mm - width 1)
Suitable for all manifolds.**



Supplied with:
2x plates
2x screws M4x6 UNI 5931
2x nuts

Part Number	Availability
PCF-EN531	✓

New

Series D Valves and Solenoid Valves

3/2, 2 x 3/2, 5/2, 5/3 way

With outlets on the body - For individual or manifold assembly

Size 10.5 - 25 mm

VALVES AND SOLENOID VALVES

3/2 Way Pneumatically actuated valve, monostable - Size 10.5

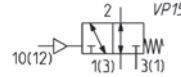
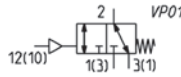

- ✓ Ex Stock
- ✂ UK Assembly
- Ⓢ Please Call Sales Office

Part Number	Availability	Connection	Function	Symbol	Flow Rate (NI/min)	Operating Pressures (Bar)	Pilot Supply Pressures (Bar)
D1PVA-P0-T	Ⓢ	M7	NC	VP01	200	-0.9-10	2.5- 10
D1PVA-Q0-T	Ⓢ	M7	NO	VP15	200	-0.9-10	2.5-10

Technical Data

Media

Compressed, filtered and non-lubricated air in class 7.4.4 according to ISO 8573-1:2010. In case lubrication should be necessary, only use oils, with a maximum viscosity of 32 Cst and the version with external servo pilot. The air quality for the servo pilot should be of class 7.4.4 according to ISO 8573-1:2010

Ambient Temperature

0°C to +50°C.

Full Data Sheet and Dimensions at <https://store.camozzi.co.uk>

ACCESSORIES

STRAIGHT CONNECTION	PILOT PORT
6512 4-M7-M	6512 4-M5
6512 4-M7-M	6512 4-M5

5/2 Way Pneumatically actuated valve, monostable - Size 10.5

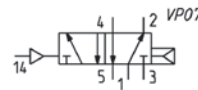

Part Number	Availability	Connection	Symbol	Flow Rate (NI/min)	Operating Pressures (Bar)	Pilot Supply Pressures (Bar)
D1PVA-M0-T	Ⓢ	M7	VP07	270	2.5- 10	2.5- 10

STRAIGHT CONNECTION	PILOT PORT
6512 4-M7-M	6512 4-M5

5/2 Way Pneumatically actuated valve, bistable - Size 10.5

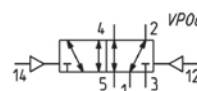

Part Number	Availability	Connection	Symbol	Flow Rate (NI/min)	Operating Pressures (Bar)	Pilot Supply Pressures (Bar)
D1PVA-B0-T	Ⓢ	M7	VP06	270	-0.9- 10	1.5- 7

STRAIGHT CONNECTION	PILOT PORT
6512 4-M7-M	6512 4-M5

5/3 Way Pneumatically actuated valve - Size 10.5



- ✓ Ex Stock
- ✂ UK Assembly
- 📞 Please Call Sales Office



Part Number	Availability	Connection	Function	Symbol	Flow Rate (NI/min)	Operating Pressures (Bar)	Pilot Supply Pressures (Bar)
D1PVA-V0-T	☉	M7	CC	VP08	250	-0.9-10	2.5-10
D1PVA-K0-T	☉	M7	CO	VP09	220	-0.9-10	2.5-10
D1PVA-N0-T	☉	M7	CP	VP10	220	-0.9-10	2.5-10

ACCESSORIES

STRAIGHT CONNECTION	PILOT PORT
6512 4-M7-M	6512 4-M5
6512 4-M7-M	6512 4-M5
6512 4-M7-M	6512 4-M5

2x 3/2 Way Pneumatically actuated valve - Size 10.5

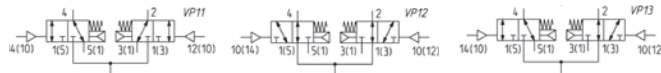

Part Number	Availability	Connection	Function	Symbol	Flow Rate (NI/min)	Operating Pressures (Bar)	Pilot Supply Pressures (Bar)
D1PVA-C0-T	☉	M7	NC	VP11	250	-0.9-10	2.5-10
D1PVA-A0-T	☉	M7	NO	VP12	220	-0.9-10	2.5-10
D1PVA-G0-T	☉	M7	NC+NO	VP13	220	-0.9-10	2.5-10

STRAIGHT CONNECTION	PILOT PORT
6512 4-M7-M	6512 4-M5
6512 4-M7-M	6512 4-M5
6512 4-M7-M	6512 4-M5

3/2 Way Pneumatically actuated valve, monostable - Size 25

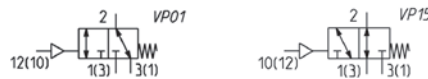

Part Number	Availability	Connection	Function	Symbol	Flow Rate (NI/min)	Operating Pressures (Bar)	Pilot Supply Pressures (Bar)
D4PVA-P0-T	☉	3/8	NC	VP01	1800	-0.9-10	2.5-10
D4PVA-Q0-T	☉	3/8	NO	VP15	1800	-0.9-10	2.5-10

STRAIGHT CONNECTION	ELBOW FITTING	PILOT PORT
S6510 8-3/8	S6520 8-3/8	6512 4-M5
S6510 8-3/8	S6520 8-3/8	6512 4-M5

5/2 Way Pneumatically actuated valve, monostable - Size 25

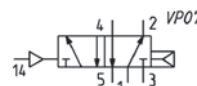

Part Number	Availability	Connection	Symbol	Flow Rate (NI/min)	Operating Pressures (Bar)	Pilot Supply Pressures (Bar)
D4PVA-M0-T	☉	3/8	VP07	2000	2.5-10	2.5-10

STRAIGHT CONNECTION	ELBOW FITTING	PILOT PORT
S6510 8-3/8	S6520 8-3/8	6512 4-M5

5/2 Way Pneumatically actuated valve, bistable - Size 25



- ✓ Ex Stock
- ✎ UK Assembly
- ☎ Please Call Sales Office

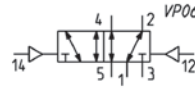

Part Number	Availability	Connection	Symbol	Flow Rate (NI/min)	Operating Pressures (Bar)	Pilot Supply Pressures (Bar)
D4PVA-B0-T	☎	3/8	VP06	2000	-0.9-10	1.5-10

ACCESSORIES

STRAIGHT CONNECTION	ELBOW FITTING	PILOT PORT
S6510 8-3/8	S6520 8-3/8	6512 4-M5

5/3 Way Pneumatically actuated valve - Size 25



Part Number	Availability	Connection	Function	Symbol	Flow Rate (NI/min)	Operating Pressures (Bar)	Pilot Supply Pressures (Bar)
D4PVA-V0-T	☎	3/8	CC	VP08	1800	-0.9-10	2.5-10
D4PVA-K0-T	☎	3/8	CO	VP09	1800	-0.9-10	2.5-10
D4PVA-N0-T	☎	3/8	CP	VP10	1800	-0.9-10	2.5-10

STRAIGHT CONNECTION	ELBOW FITTING	PILOT PORT
S6510 8-3/8	S6520 8-3/8	6512 4-M5
S6510 8-3/8	S6520 8-3/8	6512 4-M5
S6510 8-3/8	S6520 8-3/8	6512 4-M5

2x 3/2 Way Pneumatically actuated valve - Size 25

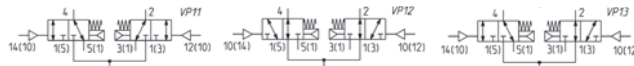

Part Number	Availability	Connection	Function	Symbol	Flow Rate (NI/min)	Operating Pressures (Bar)	Pilot Supply Pressures (Bar)
D4PVA-C0-T	☎	3/8	NC	VP11	1800	-0.9-10	3-10
D4PVA-A0-T	☎	3/8	NO	VP12	1800	-0.9-10	3-10
D4PVA-G0-T	☎	3/8	NO+NC	VP13	1800	-0.9-10	3-10

STRAIGHT CONNECTION	ELBOW FITTING	PILOT PORT
S6510 8-3/8	S6520 8-3/8	6512 4-M5
S6510 8-3/8	S6520 8-3/8	6512 4-M5
S6510 8-3/8	S6520 8-3/8	6512 4-M5

3/2 Way Solenoid Valve, monostable - Size 10.5



- ✓ Ex Stock
- ✚ UK Assembly
- 📞 Please Call Sales Office

Micro Plugin Connector

Part Number	Availability	Connection	Function	Symbol	Flow Rate (NI/min)	Operating Pressures (Bar)	Pilot Supply Pressures (Bar)
D1EVA-PR-T	🕒	M7	NC	EV10	200	2.5-7	-
D1EVA-PZR-T	🕒	M7	NC	EV11	200	-0.9-10	2.5-7
D1EVA-QR-T	🕒	M7	NO	EV12	200	2.5-7	-
D1EVA-QZR-T	🕒	M7	NO	EV13	200	-0.9-10	2.5-7

Electric M8 Connector

Part Number	Availability	Connection	Function	Symbol	Flow Rate (NI/min)	Operating Pressures (Bar)	Pilot Supply Pressures (Bar)
D1CVA-PR-T	🕒	M7	NC	EV10	200	2.5-7	-
D1CVA-PZR-T	🕒	M7	NC	EV11	200	-0.9-10	2.5-7
D1CVA-QR-T	🕒	M7	NO	EV12	200	2.5-7	-
D1CVA-QZR-T	🕒	M7	NO	EV13	200	-0.9-10	2.5-7

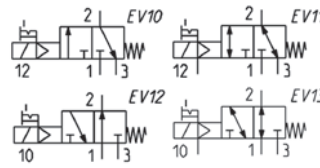

ACCESSORIES

STRAIGHT CONNECTION	PILOT PORT
6512 4-M7-M	6512 4-M5
6512 4-M7-M	6512 4-M5
6512 4-M7-M	6512 4-M5
6512 4-M7-M	6512 4-M5

5/2 Way Solenoid Valve, monostable - Size 10.5



Micro Plugin Connector

Part Number	Availability	Connection	Symbol	Flow Rate (NI/min)	Operating Pressures (Bar)	Pilot Supply Pressures (Bar)
D1EVA-MR-T	🕒	M7	EV21	270	2.5-7	-
D1EVA-MZR-T	🕒	M7	EV22	270	-0.9-10	2.5-7

Electric M8 Connector

Part Number	Availability	Connection	Symbol	Flow Rate (NI/min)	Operating Pressures (Bar)	Pilot Supply Pressures (Bar)
D1CVA-MR-T	🕒	M7	EV21	270	2.5-7	-
D1CVA-MZR-T	🕒	M7	EV22	270	-0.9-10	2.5-7

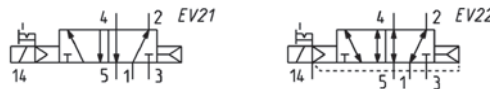

ACCESSORIES

STRAIGHT CONNECTION	PILOT PORT
6512 4-M7-M	6512 4-M5
6512 4-M7-M	6512 4-M5

Customised Solutions

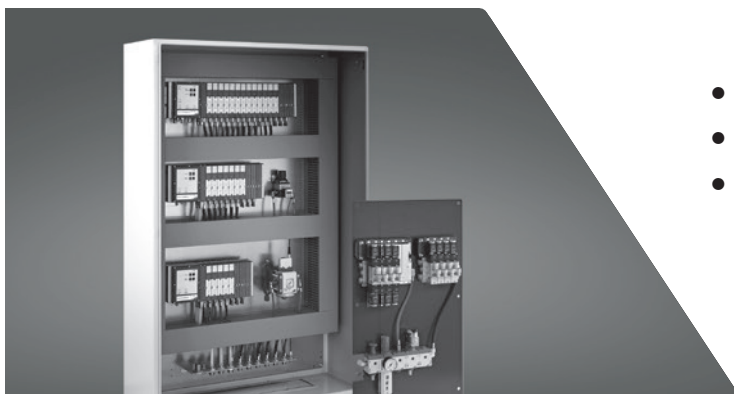

- Pre-Assembled Kits
- Special Products
- Control Cabinets and Systems

5/2 Way Solenoid Valve, bistable - Size 10.5



- ✓ Ex Stock
- 🔧 UK Assembly
- 📞 Please Call Sales Office

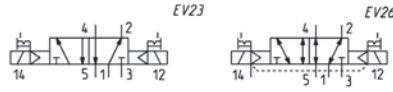

Micro Plugin Connector

Part Number	Availability	Connection	Symbol	Flow Rate (NI/min)	Operating Pressures (Bar)	Pilot Supply Pressures (Bar)
D1EVA-BR-T	Ⓞ	M7	EV23	270	1.5-7	-
D1EVA-BZR-T	Ⓞ	M7	EV26	270	-0.9-10	1.5-7

Electric M8 Connector

Part Number	Availability	Connection	Symbol	Flow Rate (NI/min)	Operating Pressures (Bar)	Pilot Supply Pressures (Bar)
D1CVA-BR-T	Ⓞ	M7	EV23	270	1.5-7	-
D1CVA-BZR-T	Ⓞ	M7	EV26	270	-0.9-10	1.5-7

ACCESSORIES

STRAIGHT CONNECTION	PILOT PORT
6512 4-M7-M	6512 4-M5
6512 4-M7-M	6512 4-M5

5/3 Way Solenoid Valve - Size 10.5

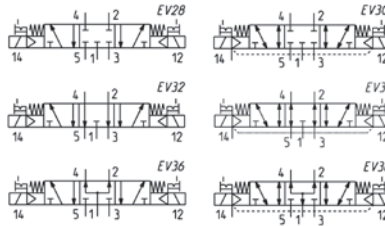

Micro Plugin Connector

Part Number	Availability	Connection	Function	Symbol	Flow Rate (NI/min)	Operating Pressures (Bar)	Pilot Supply Pressures (Bar)
D1EVA-VR-T	Ⓞ	M7	CC	EV28	250	2.5-7	-
D1EVA-VZR-T	Ⓞ	M7	CC	EV30	250	-0.9-10	2.5-7
D1EVA-KR-T	Ⓞ	M7	CO	EV32	220	2.5-7	-
D1EVA-KZR-T	Ⓞ	M7	CO	EV33	220	-0.9-10	2.5-7
D1EVA-NR-T	Ⓞ	M7	CP	EV36	220	2.5-7	-
D1EVA-NZR-T	Ⓞ	M7	CP	EV38	220	-0.9-10	2.5-7

Micro Plugin Connector

Part Number	Availability	Connection	Function	Symbol	Flow Rate (NI/min)	Operating Pressures (Bar)	Pilot Supply Pressures (Bar)
D1CVA-VR-T	Ⓞ	M7	CC	EV28	250	2.5-7	-
D1CVA-VZR-T	Ⓞ	M7	CC	EV30	250	-0.9-10	2.5-7
D1CVA-KR-T	Ⓞ	M7	CO	EV32	220	2.5-7	-
D1CVA-KZR-T	Ⓞ	M7	CO	EV33	220	-0.9-10	2.5-7
D1CVA-NR-T	Ⓞ	M7	CP	EV36	220	2.5-7	-
D1CVA-NZR-T	Ⓞ	M7	CP	EV38	220	-0.9-10	2.5-7

ACCESSORIES

STRAIGHT CONNECTION	PILOT PORT
6512 4-M7-M	6512 4-M5
6512 4-M7-M	6512 4-M5
6512 4-M7-M	6512 4-M5
6512 4-M7-M	6512 4-M5
6512 4-M7-M	6512 4-M5
6512 4-M7-M	6512 4-M5

2x3/2 Way Solenoid Valve - Size 10.5

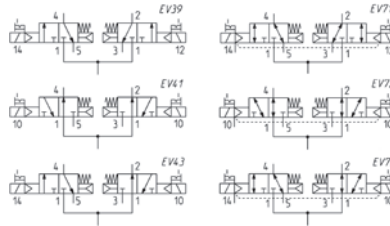

- ✓ Ex Stock
- ✚ UK Assembly
- Ⓞ Please Call Sales Office

Micro Plugin Connector

Part Number	Availability	Connection	Function	Symbol	Flow Rate (NI/min)	Operating Pressures (Bar)	Pilot Supply Pressures (Bar)
D1EVA-CR-T	Ⓞ	M7	2 x 3/2 NC	EV39	250	2.5-7	-
D1EVA-CZR-T	Ⓞ	M7	2 x 3/2 NC	EV71	250	-0.9-10	2.5-7
D1EVA-AR-T	Ⓞ	M7	2 x 3/2 NO	EV41	220	2.5-7	-
D1EVA-AZR-T	Ⓞ	M7	2 x 3/2 NO	EV72	220	-0.9-10	2.5-7
D1EVA-GR-T	Ⓞ	M7	1 x 3/2 NC +1 x 3/2 NO	EV43	220	2.5-7	-
D1EVA-GZR-T	Ⓞ	M7	1 x 3/2 NC +1 x 3/2 NO	EV73	220	-0.9-10	2.5-7

Micro Plugin Connector

Part Number	Availability	Connection	Function	Symbol	Flow Rate (NI/min)	Operating Pressures (Bar)	Pilot Supply Pressures (Bar)
D1CVA-CR-T	Ⓞ	M7	2 x 3/2 NC	EV39	250	2.5-7	-
D1CVA-CZR-T	Ⓞ	M7	2 x 3/2 NC	EV71	250	-0.9-10	2.5-7
D1CVA-AR-T	Ⓞ	M7	2 x 3/2 NO	EV41	220	2.5-7	-
D1CVA-AZR-T	Ⓞ	M7	2 x 3/2 NO	EV72	220	-0.9-10	2.5-7
D1CVA-GR-T	Ⓞ	M7	1 x 3/2 NC +1 x 3/2 NO	EV43	220	2.5-7	-
D1CVA-GZR-T	Ⓞ	M7	1 x 3/2 NC +1 x 3/2 NO	EV73	220	-0.9-10	2.5-7

ACCESSORIES

STRAIGHT CONNECTION	PILOT PORT
6512 4-M7-M	6512 4-M5
6512 4-M7-M	6512 4-M5
6512 4-M7-M	6512 4-M5
6512 4-M7-M	6512 4-M5
6512 4-M7-M	6512 4-M5
6512 4-M7-M	6512 4-M5

VALVES AND SOLENOID VALVES

3/2 Way Solenoid Valve, monostable - Size 25

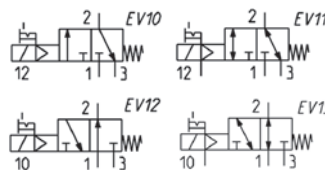

Micro Plugin Connector

Part Number	Availability	Connection	Function	Symbol	Flow Rate (NI/min)	Operating Pressures (Bar)	Pilot Supply Pressures (Bar)
D43VA-PR-T	Ⓞ	3/8	NC	EV10	1800	2.5-10	-
D43VA-PZR-T	Ⓞ	3/8	NC	EV11	1800	-0.9-10	2.5-10
D43VA-QR-T	Ⓞ	3/8	NO	EV12	1800	2.5-7	-
D43VA-QZR-T	Ⓞ	3/8	NO	EV13	1800	-0.9-10	2.5-10

ACCESSORIES

STRAIGHT CONNECTION	ELBOW FITTING	PILOT PORT
S6510 8-3/8	S6520 8-3/8	6512 4-M5
S6510 8-3/8	S6520 8-3/8	6512 4-M5
S6510 8-3/8	S6520 8-3/8	6512 4-M5
S6510 8-3/8	S6520 8-3/8	6512 4-M5

5/2 Way Solenoid Valve, monostable - Size 25



- ✓ Ex Stock
- ✎ UK Assembly
- ☎ Please Call Sales Office



Part Number	Availability	Connection	Symbol	Flow Rate (NI/min)	Operating Pressures (Bar)	Pilot Supply Pressures (Bar)
D43VA-MR-T	☎	3/8	EV21	2000	2.5-10	-
D43VA-MZR-T	☎	3/8	EV22	2000	-0.9-10	2.5-10

ACCESSORIES

STRAIGHT CONNECTION	ELBOW FITTING	PILOT PORT
S6510 8-3/8	S6520 8-3/8	6512 4-M5
S6510 8-3/8	S6520 8-3/8	6512 4-M5

5/2 Way Solenoid Valve, bistable - Size 25



Part Number	Availability	Connection	Symbol	Flow Rate (NI/min)	Operating Pressures (Bar)	Pilot Supply Pressures (Bar)
D43VA-BR-T	☎	3/8	EV23	2000	1.5-10	-
D43VA-BZR-T	☎	3/8	EV26	2000	-0.9-10	1.5-10

ACCESSORIES

STRAIGHT CONNECTION	ELBOW FITTING	PILOT PORT
S6510 8-3/8	S6520 8-3/8	6512 4-M5
S6510 8-3/8	S6520 8-3/8	6512 4-M5

5/3 Way Solenoid Valve - Size 25

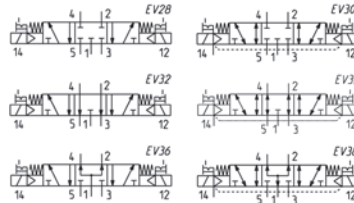

Part Number	Availability	Connection	Function	Symbol	Flow Rate (NI/min)	Operating Pressures (Bar)	Pilot Supply Pressures (Bar)
D43VA-VR-T	☎	3/8	CC	EV28	1800	2.5-10	-
D43VA-VZR-T	☎	3/8	CC	EV30	1800	-0.9-10	2.5-10
D43VA-KR-T	☎	3/8	CO	EV32	1800	2.5-10	-
D43VA-KZR-T	☎	3/8	CO	EV33	1800	-0.9-10	2.5-10
D43VA-NR-T	☎	3/8	CP	EV36	1800	2.5-10	-
D43VA-NZR-T	☎	3/8	CP	EV38	1800	-0.9-10	2.5-10

ACCESSORIES

STRAIGHT CONNECTION	ELBOW FITTING	PILOT PORT
S6510 8-3/8	S6520 8-3/8	6512 4-M5
S6510 8-3/8	S6520 8-3/8	6512 4-M5
S6510 8-3/8	S6520 8-3/8	6512 4-M5
S6510 8-3/8	S6520 8-3/8	6512 4-M5
S6510 8-3/8	S6520 8-3/8	6512 4-M5
S6510 8-3/8	S6520 8-3/8	6512 4-M5

2x3/2 Way Solenoid Valve - Size 25

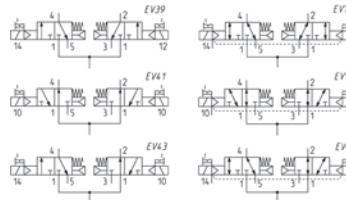

Part Number	Availability	Connection	Function	Symbol	Flow Rate (NI/min)	Operating Pressures (Bar)	Pilot Supply Pressures (Bar)
D43VA-CR-T	☎	3/8	2 x 3/2 NC	EV39	1800	3.5-10	-
D43VA-CZR-T	☎	3/8	2 x 3/2 NC	EV71	1800	-0.9-10	3.5-10
D43VA-AR-T	☎	3/8	2 x 3/2 NO	EV41	1800	3.5-10	-
D43VA-AZR-T	☎	3/8	2 x 3/2 NO	EV72	1800	-0.9-10	3.5-10
D43VA-GR-T	☎	3/8	1 x 3/2 NC + 1 x 3/2 NO	EV43	1800	3.5-10	-
D43VA-GZR-T	☎	3/8	1 x 3/2 NC + 1 x 3/2 NO	EV73	1800	-0.9-10	3.5-10

ACCESSORIES

STRAIGHT CONNECTION	ELBOW FITTING	PILOT PORT
S6510 8-3/8	S6520 8-3/8	6512 4-M5
S6510 8-3/8	S6520 8-3/8	6512 4-M5
S6510 8-3/8	S6520 8-3/8	6512 4-M5
S6510 8-3/8	S6520 8-3/8	6512 4-M5
S6510 8-3/8	S6520 8-3/8	6512 4-M5
S6510 8-3/8	S6520 8-3/8	6512 4-M5

CODING EXAMPLE

D	1	E	VA	-	B	P	-	BS
----------	----------	----------	-----------	----------	----------	----------	----------	-----------

D	SERIES	
1	SIZE: 1 = 10,5 mm 4 = 25 mm	
F	ACTUATION: E = electric (only for D1) 3 = electric 15 mm (only for D4) C = electric with M8 connections (only for D1) P = pneumatic	
VA	COMPONENT: VA = Valve with threaded body	
B	TYPE OF SOLENOID VALVE: M (MZ) = 5/2 Monostable B (BZ) = 5/2 Bistable P (PZ) = 3/2 NC Q (QZ) = 3/2 NO C (CZ) = 2 x 3/2 NC A (AZ) = 2 x 3/2 NO G (GZ) = 2 x 3/2 (NC+NO) N (NZ) = 5/3 CP V (VZ) = 5/3 CC K (KZ) = 5/3 CO	(.Z) = version with external servo pilot, not for version P
P	TYPE OF MANUAL OVERRIDE: P = push button (not for D4) R = with push and turn device 0 = without manual override (for version P)	
DS	CONNECTIONS: T = Thread A (AS) = Ø4 (D1) fittings 6512 4-M7-M (silencer 2931 M7) B (BS) = Ø6 (D1) fittings 6512 6-M7-M (silencer 2931 M7) D (DS) = Ø10 (D4) fittings 6512 10-3/8 (silencer 2931 3/8) E (ES) = Ø12 (D4) fittings 6512 12-3/8 (silencer 2931 3/8) F (FS) = Ø14 (D4) fittings 6512 14-3/8 (silencer 2931 3/8)	(.S) version with silencer
For alternating current applications, use a connector with bridge rectifier, only for D4. (See the connectors at the end of this section)		

UK Cylinder Service



Reduce Lead Times for Pneumatic Cylinders

- Built the same or next day
- Includes many cylinder types



Manifolds for Valves with outlets on the body



- ✓ Ex Stock
- 🔧 UK Assembly
- 📞 Please Call Sales Office

Part Number	Availability	Number of Positions
Sub-base (with outlets on the body) Size 10.5		
DCA10-2	Ⓞ	2
DCA10-3	Ⓞ	3
DCA10-4	Ⓞ	4
DCA10-5	Ⓞ	5
DCA10-6	Ⓞ	6
DCA10-7	Ⓞ	7
DCA10-8	Ⓞ	8
DCA10-9	Ⓞ	9
DCA10-10	Ⓞ	10
DCA10-11	Ⓞ	11
DCA10-12	Ⓞ	12
DCA10-13	Ⓞ	13
DCA10-14	Ⓞ	14
DCA10-15	Ⓞ	15
DCA10-16	Ⓞ	16
DCA10-17	Ⓞ	17
DCA10-18	Ⓞ	18
DCA10-19	Ⓞ	19
Sub-base (with outlets on the body) Size 25		
DCA40-2	Ⓞ	2
DCA40-3	Ⓞ	3
DCA40-4	Ⓞ	4
DCA40-5	Ⓞ	5
DCA40-6	Ⓞ	6
DCA40-7	Ⓞ	7
DCA40-8	Ⓞ	8
DCA40-9	Ⓞ	9
DCA40-10	Ⓞ	10
DCA40-11	Ⓞ	11
DCA40-12	Ⓞ	12
DCA40-13	Ⓞ	13
DCA40-14	Ⓞ	14
DCA40-15	Ⓞ	15
DCA40-16	Ⓞ	16
DCA40-17	Ⓞ	17
DCA40-18	Ⓞ	18
DCA40-19	Ⓞ	19

ACCESSORIES

INLET FITTING	SILENCER	BLANKING PLUG
		
S6510 6-1/8	2901 1/8	S2610 1/8
S6510 6-1/8	2901 1/8	S2610 1/8
S6510 6-1/8	2901 1/8	S2610 1/8
S6510 6-1/8	2901 1/8	S2610 1/8
S6510 6-1/8	2901 1/8	S2610 1/8
S6510 6-1/8	2901 1/8	S2610 1/8
S6510 6-1/8	2901 1/8	S2610 1/8
S6510 6-1/8	2901 1/8	S2610 1/8
S6510 6-1/8	2901 1/8	S2610 1/8
S6510 6-1/8	2901 1/8	S2610 1/8
S6510 6-1/8	2901 1/8	S2610 1/8
S6510 6-1/8	2901 1/8	S2610 1/8
S6510 6-1/8	2901 1/8	S2610 1/8
S6510 6-1/8	2901 1/8	S2610 1/8
S6510 6-1/8	2901 1/8	S2610 1/8
S6510 6-1/2	2901 1/2	S2610 1/2
S6510 6-1/2	2901 1/2	S2610 1/2
S6510 6-1/2	2901 1/2	S2610 1/2
S6510 6-1/2	2901 1/2	S2610 1/2
S6510 6-1/2	2901 1/2	S2610 1/2
S6510 6-1/2	2901 1/2	S2610 1/2
S6510 6-1/2	2901 1/2	S2610 1/2
S6510 6-1/2	2901 1/2	S2610 1/2
S6510 6-1/2	2901 1/2	S2610 1/2
S6510 6-1/2	2901 1/2	S2610 1/2
S6510 6-1/2	2901 1/2	S2610 1/2
S6510 6-1/2	2901 1/2	S2610 1/2
S6510 6-1/2	2901 1/2	S2610 1/2
S6510 6-1/2	2901 1/2	S2610 1/2
S6510 6-1/2	2901 1/2	S2610 1/2
S6510 6-1/2	2901 1/2	S2610 1/2
S6510 6-1/2	2901 1/2	S2610 1/2
S6510 6-1/2	2901 1/2	S2610 1/2

CODING EXAMPLE

DC	A	1	0	-	12
DC SERIES: DC	A MANIFOLD: A = For type VA valves	1 SIZE: 1 = SIZE 10.5 4 = SIZE 25	0 BODY TYPE: 0 = body for sub-base assembly	12 N° OF POSITION: 2 3 4 ... 19	

CODING EXAMPLE MANIFOLD WITH VALVES AND FITTINGS

DC	A	1	E	P	-	MBMXCVB	-	3BX2AB	-	CSL	-	R
----	---	---	---	---	---	---------	---	--------	---	-----	---	---

DC	SERIES: DC											
A	MANIFOLD WITH VALVES: A = For type VA valve					3BX2AB		CONNECTIONS ON VALVE POSITIONS T = Thread A = Fittings Ø4 (D1) B = Fittings Ø6 (D1) C = Fittings Ø8 (D4) D = Fittings Ø10 (D4) E = Fittings Ø12 (D4) F = Fittings Ø14 (D4) L = Free position (code D1AVA-L) X = Additional supply and exhaust (code D1AVA-X) Y = Additional supply and exhaust with silencer (code D1AVA-Y)				
1	SIZE 1 = SIZE 10,5 4 = SIZE 25											
E	ACTUATION E = Electric P = Pneumatic C = Electric with M8 connector (D1) 3 = Electric with solenoid 15 mm (D4)											
P	TYPE OF MANUAL OVERRIDE P = push button (not for D4) R = with push and turn device 0 = without manual override (for version P)					CSL		MANIFOLD CONNECTIONS T = Thread C (CS) = Fittings Ø 8, 6512 8-1/8-M (Silnecer 2931 1/8) D (DS) = Fittings Ø 10, 6512 10-1/8-M (Silnecer 2931 1/8) E (ES) = Fittings Ø 12, S6510 12-1/2 (Silnecer 2931 1/2) F (FS) = Fittings Ø 14, S6510 14-1/2 (Silnecer 2931 1/2) G (GS) = Fittings Ø 16, S6510 16-1/2 (Silnecer 2931 1/2) CONNECTION SIDE = both L = left (right closed) R = right (left closed) (.S) Version with silencer				
MBMXCVB	TYPE OF VALVE / SOLENOID VALVE M (MZ) = 5/2 Monostable B (BZ) = 5/2 Bistable C (CZ) = 2 x 3/2 NC A (AZ) = 2 x 3/2 NO G (GZ) = 2 x 3/2 (NC + NO) V (VZ) = 5/3 CC K (KZ) = 5/3 CO N (NZ) = 5/3 CP L = Free position X = Additional supply and exhaust Y = Additional supply and exhaust with silencer (.Z) = Version with external servo pilot, not for version P							R				
								FIXING: = DIRECT R = PORT FOR DIN RAIL				

Series D Accessories

- ✓ Ex Stock
- 🔧 UK Assembly
- 📞 Please Call Sales Office

Mounted Brackets for DIN Rail



Part Number	Availability
PCF-E520	🕒

Blanking plate for manifolds (Free position L)



Part Number	Availability	Size
D1AVA-L	🕒	10.5
D4AVA-L	🕒	25

Module X for additional supply and exhaust for size 10.5



Part Number	Availability	Size
D1AVA-X	🕒	11

Module Y for additional supply and exhaust with silencer for size 10.5



Part Number	Availability	Size
D1AVA-Y	🕒	11

Module X for additional supply and exhaust for size 25



Part Number	Availability	Size
D4AVA-X	🕒	25.5

Module Y for additional supply and exhaust with silencer for size 25



Part Number	Availability	Size
D4AVA-Y	🕒	25.5

Series 3 and 4 Electropneumatically Operated Valves

Connections: Series 3 - 1/8, 1/4, 3/2 - way, 5/2 - way, 5/3 - way and 2 x 3/2 - way
Series 4 - 1/8, 1/4 and 1/2, 3/2, 5/2 and 5/3 - way

3/2 - way single solenoid valve - 1/8 - N.C. and N.O.



- ✓ Ex Stock
- ✎ UK Assembly
- ☎ Please Call Sales Office

Part Number	Availability	Mounting	Function	Symbol	Flow Rate (NI/min)	Operating Pressures (Bar)
338-015-02-*	✓	in-line	3/2 NC	EV10	700	2.5-10
338L-015-02-*	✓	on manifold	3/2 NC	EV10	700	2.5-10
348-015-02-*	✓	in-line	3/2 NO	EV12	700	2.5-10
348L-015-02-*	✓	on manifold	3/2 NO	EV12	700	2.5-10

*Coil sold separately, see page opposite for voltage options (U7 Solenoid Coils)

Technical Data

Media

Filtered air, without lubrication.

If lubricated air is used, it is recommended to use oil ISO VG32.

Once applied the lubrication should never be interrupted

Operating Temperature

0°C to +60°C

(with dry air -20°C to +60°C)

Full Data Sheet and Dimensions at

<https://store.camozzi.co.uk>

ACCESSORIES

COILS	CONNECTOR	STRAIGHT CONNECTION	ELBOW FITTING
U7*	KB132000B9	S6510 6-1/8	S6520 6-1/8
U7*	KB132000B9	S6510 6-1/8	S6520 6-1/8
U7*	KB132000B9	S6510 6-1/8	S6520 6-1/8
U7*	KB132000B9	S6510 6-1/8	S6520 6-1/8

For more connector options, including LED versions please see page 134-137

3/2 - way double solenoid valve - 1/8 N.C

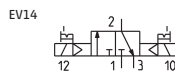

Part Number	Availability	Mounting	Function	Symbol	Flow Rate (NI/min)	Operating Pressures (Bar)
338-011-02-*	✓	in-line	3/2 NC	EV14	700	1.5-10
338L-011-02-*	✓	on manifold	3/2 NC	EV14	700	1.5-10

*Coil sold separately, see page opposite for voltage options (U7 Solenoid Coils)

COILS	CONNECTOR	STRAIGHT CONNECTION	ELBOW FITTING
U7*x2	KB132000B9x2	S6510 6-1/8	S6520 6-1/8
U7*x2	KB132000B9x2	S6510 6-1/8	S6520 6-1/8

For more connector options, including LED versions please see page 134-137

2 x 3/2 - way double solenoid valve - 1/8 - N.C. and N.O.

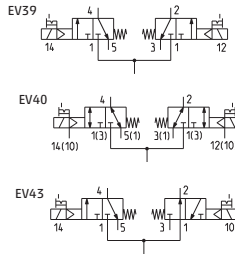

- ✓ Ex Stock
- ✎ UK Assembly
- ☎ Please Call Sales Office

Part Number	Availability	Function	Symbol	Flow Rate (NI/min)	Operating Pressures (Bar)	Minimum Pilot Pressures (Bar)
338D-015-02-*	✓	3/2 NC	EV39	700	2.5-10	-
338D-E15-02-*	✓	3/2 NC	EV40	700	-0.9-10	2.5
398D-015-02-*	✓	1x3/2 NC + 1x3/2 NO	EV43	700	2.5-10	-
348D-015-02-*	✓	3/2 NO	EV41	700	2.5-10	2.5
348D-E15-02-*	✓	3/2 NO	EV44	700	-0.9-10	2.5
398D-E15-02-*	✓	1x3/2 NC + 1x3/2 NO	EV42	700	-0.9-10	2.5

*Coil sold separately, see page below for voltage options (U7 Solenoid Coils)

ACCESSORIES



COILS	CONNECTOR	STRAIGHT CONNECTION	ELBOW FITTING
U7*x2	KB132000B9x2	S6510 6-1/8	S6520 6-1/8
U7*x2	KB132000B9x2	S6510 6-1/8	S6520 6-1/8
U7*x2	KB132000B9x2	S6510 6-1/8	S6520 6-1/8
U7*x2	KB132000B9x2	S6510 6-1/8	S6520 6-1/8
U7*x2	KB132000B9x2	S6510 6-1/8	S6520 6-1/8

For more connector options, including LED versions please see page 134-137

5/2 - way single solenoid valve - 1/8

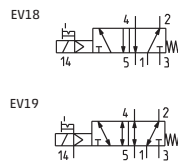

Part Number	Availability	Function	Symbol	Flow Rate (NI/min)	Operating Pressures (Bar)	Minimum Pilot Pressures (Bar)
358-015-02-*	✓	5/2	EV18	700	2.5-10	-
358-E15-02-*	✓	5/2	EV19	700	-0.9-10	2.5

*Coil sold separately, see page below for voltage options (U7 Solenoid Coils)



COILS	CONNECTOR	STRAIGHT CONNECTION	ELBOW FITTING
U7*	KB132000B9	S6510 6-1/8	S6520 6-1/8
U7*	KB132000B9	S6510 6-1/8	S6520 6-1/8

For more connector options, including LED versions please see page 134-137

U7* Solenoid Coils

Solenoid Voltages U7 (Material = PET)				Solenoid Voltages U7 (Material = PET)			
U7H	24V	50/60 Hz	3.5VA	U7J	230V	50/60Hz	3.5VA
	12V	DC	3.1W		240V	50/60Hz	4VA
U7K	110V	AC 50/60Hz	4.3VA	U77	24V	DC	3W
	125V	AC 50/60Hz	5.5VA				

For full range of solenoid coils please see page 133



5/2 - way double solenoid valve - 1/8

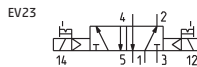

- ✓ Ex Stock
- ✎ UK Assembly
- 📞 Please Call Sales Office

Part Number	Availability	Function	Symbol	Flow Rate (NI/min)	Operating Pressures (Bar)	Minimum Pilot Pressures (Bar)
358-011-02-*	✓	5/2	EV23	700	1.5-10	-
358-E11-02-*	✓	5/2	EV25	700	-0.9-10	1.5-10

*Coil sold separately, see page opposite for voltage options (U7 Solenoid Coils)

ACCESSORIES



COILS	CONNECTOR	STRAIGHT CONNECTION	ELBOW FITTING
U7*x2	KB132000B9x2	S6510 6-1/8	S6520 6-1/8
U7*x2	KB132000B9x2	S6510 6-1/8	S6520 6-1/8

For more connector options, including LED versions please see page 134-137

5/3 - way double solenoid valve - 1/8 - C.C., C.O. and C.P.

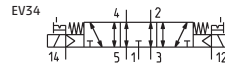
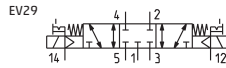
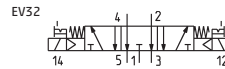
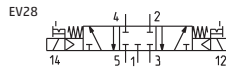

Part Number	Availability	Function	Symbol	Flow Rate (NI/min)	Operating Pressures (Bar)	Minimum Pilot Pressures (Bar)
368-011-02-*	✓	5/3 CC	EV28	700	2-10	-
368-E11-02-*	✓	5/3 CC	EV29	700	-0.9-10	2-10
378-011-02-*	✓	5/3 CO	EV32	700	2-10	-
378-E11-02-*	✓	5/3 CO	EV34	700	-0.9-10	2-10
388-011-02-*	✓	5/3 CP	EV36	700	2-10	-
388-E11-02-*	✓	5/3 CP	EV37	700	-0.9-10	2-10

*Coil sold separately, see page opposite for voltage options (U7 Solenoid Coils)

ACCESSORIES



COILS	CONNECTOR	STRAIGHT CONNECTION	ELBOW FITTING
U7*x2	KB132000B9x2	S6510 6-1/8	S6520 6-1/8
U7*x2	KB132000B9x2	S6510 6-1/8	S6520 6-1/8
U7*x2	KB132000B9x2	S6510 6-1/8	S6520 6-1/8
U7*x2	KB132000B9x2	S6510 6-1/8	S6520 6-1/8
U7*x2	KB132000B9x2	S6510 6-1/8	S6520 6-1/8
U7*x2	KB132000B9x2	S6510 6-1/8	S6520 6-1/8

For more connector options, including LED versions please see page 134-137

3/2 - way single solenoid valve - 1/4 - N.C. and N.O.

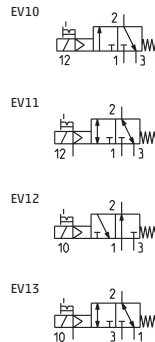

- ✓ Ex Stock
- ✎ UK Assembly
- ☎ Please Call Sales Office

Part Number	Availability	Function	Symbol	Flow Rate (NI/min)	Operating Pressures (Bar)	Minimum Pilot Pressures (Bar)
334-015-02-*	✓	3/2 NC	EV10	1300	2.5-10	-
334-E15-02-*	✓	3/2 NC	EV11	1300	-0.9-10	2.5-10
344-015-02-*	✓	3/2 NO	EV12	1300	2.5-10	-
344-E15-02-*	✓	3/2 NO	EV13	1300	-0.9-10	2.5-10

*Coil sold separately, see below for voltage options (U7 Solenoid Coils)

ACCESSORIES

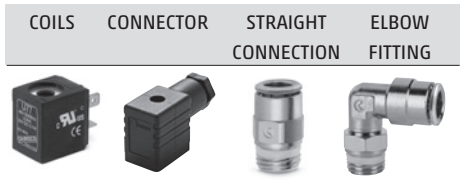

COILS	CONNECTOR	STRAIGHT CONNECTION	ELBOW FITTING
U7*	KB132000B9	S6510 6-1/4	S6520 6-1/4
U7*	KB132000B9	S6510 6-1/4	S6520 6-1/4
U7*	KB132000B9	S6510 6-1/4	S6520 6-1/4
U7*	KB132000B9	S6510 6-1/4	S6520 6-1/4

For more connector options, including LED versions please see page 134-137

3/2 - way double solenoid valve - 1/4 N.C.

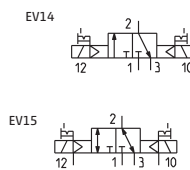

Part Number	Availability	Function	Symbol	Flow Rate (NI/min)	Operating Pressures (Bar)	Minimum Pilot Pressures (Bar)
334-011-02-*	✓	3/2 NC	EV14	1300	2.5-10	-
334-E11-02-*	✓	3/2 NC	EV15	1300	-0.9-10	2.5-10

*Coil sold separately, see below for voltage options (U7 Solenoid Coils)

ACCESSORIES



COILS	CONNECTOR	STRAIGHT CONNECTION	ELBOW FITTING
U7*x2	KB132000B9x2	S6510 6-1/4	S6520 6-1/4
U7*x2	KB132000B9x2	S6510 6-1/4	S6520 6-1/4

For more connector options, including LED versions please see page 134-137

U7* Solenoid Coils

Solenoid Voltages U7 (Material = PET)			
U7H	24V	50/60 Hz	3.5VA
	12V	DC	3.1W
U7K	110V	AC 50/60Hz	4.3VA
	125V	AC 50/60Hz	5.5VA

Solenoid Voltages U7 (Material = PET)			
U7J	230V	50/60Hz	3.5VA
	240V	50/60Hz	4VA
U77	24V	DC	3W



For full range of solenoid coils please see page 133

2 x 3/2 - way double solenoid valve - 1/4 - N.C. and N.O.

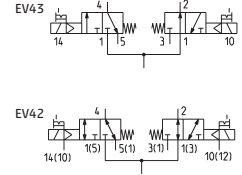
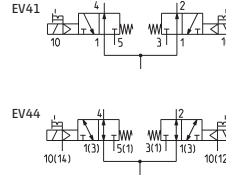
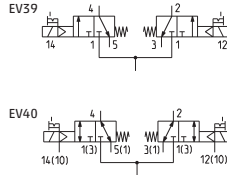

- ✓ Ex Stock
- ✎ UK Assembly
- ☎ Please Call Sales Office

Part Number	Availability	Function	Symbol	Flow Rate (NI/min)	Operating Pressures (Bar)	Minimum Pilot Pressures (Bar)
334D-015-02-*	✓	3/2 NC	EV39	1200	2.5-10	-
334D-E15-02-*	✓	3/2 NC	EV40	1200	-0.9-10	2.5-10
344D-015-02-*	✓	3/2 NO	EV41	1050	2.5-10	-
344D-E15-02-*	✓	3/2 NO	EV44	1050	-0.9-10	2.5-10
394D-015-02-*	✓	1x3/2 NC + 1x3/2 NO	EV43	1050	2-10	-
394D-E15-02-*	✓	1x3/2 NC + 1x3/2 NO	EV42	1050	-0.9-10	2.5-10

*Coil sold separately, see page opposite for voltage options (U7 Solenoid Coils)

ACCESSORIES

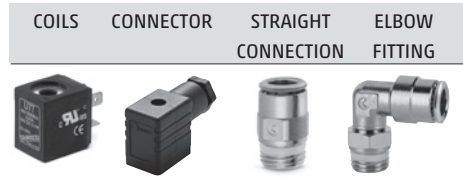

COILS	CONNECTOR	STRAIGHT CONNECTION	ELBOW FITTING
U7*x2	KB132000B9x2	S6510 8-1/4	S6520 8-1/4
U7*x2	KB132000B9x2	S6510 8-1/4	S6520 8-1/4
U7*x2	KB132000B9x2	S6510 8-1/4	S6520 8-1/4
U7*x2	KB132000B9x2	S6510 8-1/4	S6520 8-1/4
U7*x2	KB132000B9x2	S6510 8-1/4	S6520 8-1/4
U7*x2	KB132000B9x2	S6510 8-1/4	S6520 8-1/4

For more connector options, including LED versions please see page 134-137

5/2 - way single solenoid valve - 1/4

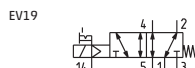
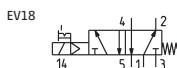

Part Number	Availability	Function	Symbol	Flow Rate (NI/min)	Operating Pressures (Bar)	Minimum Pilot Pressures (Bar)
354-015-02-*	✓	5/2	EV18	1300	2.5-10	-
354-E15-02-*	✓	5/2	EV19	1300	-0.9-10	2.5-10

*Coil sold separately, see page opposite for voltage options (U7 Solenoid Coils)

ACCESSORIES

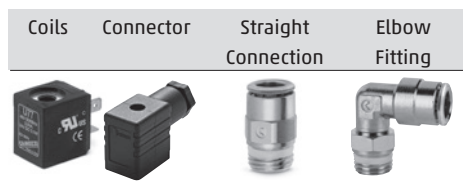

Coils	Connector	Straight Connection	Elbow Fitting
U7*	KB132000B9	S6510 8-1/4	S6520 8-1/4
U7*	KB132000B9	S6510 8-1/4	S6520 8-1/4

For more connector options, including LED versions please see page 134-137

The company reserves the right to vary models and dimensions without notice. Products designed for industrial applications. General terms and conditions for sale are available on www.camozzi.co.uk

5/2 - way double solenoid valve - 1/4



- ✓ Ex Stock
- ✎ UK Assembly
- ☎ Please Call Sales Office

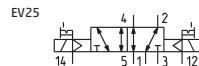
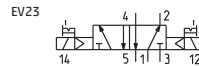

ACCESSORIES



Part Number	Availability	Function	Symbol	Flow Rate (NI/min)	Operating Pressures (Bar)	Minimum Pilot Pressures (Bar)
354-011-02-*	✓	5/2	EV23	1300	2.5-10	-
354-E11-02-*	✓	5/2	EV25	1300	-0.9-10	2.5-10

U7*x2	KB132000B9x2	S6510 8-1/4	S6520 8-1/4
U7*x2	KB132000B9x2	S6510 8-1/4	S6520 8-1/4

*Coil sold separately, see page below for voltage options (U7 Solenoid Coils)

For more connector options, including LED versions please see page 134-137

5/3 - way double solenoid valve - 1/4 - C.C., C.O. and C.P.

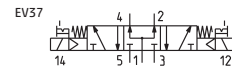
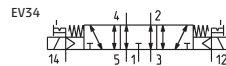
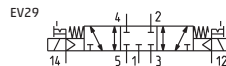
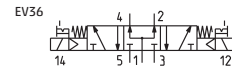
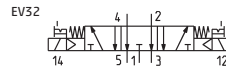
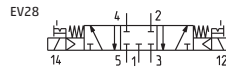

ACCESSORIES

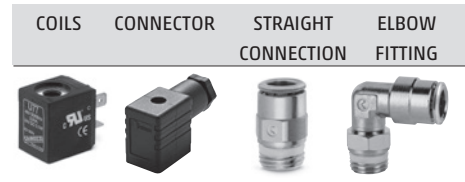

Part Number	Availability	Function	Symbol	Flow Rate (NI/min)	Operating Pressures (Bar)	Minimum Pilot Pressures (Bar)
364-011-02-*	✓	5/3 CC	EV28	1200	2.5-10	-
364-E11-02-*	✓	5/3 CC	EV29	1200	-0.9-10	2.5-10
374-011-02-*	✓	5/3 CO	EV32	1200	2.5-10	-
374-E11-02-*	✓	5/3 CO	EV34	1200	-0.9-10	2.5-10
384-011-02-*	✓	5/3 CP	EV36	1200	2.5-10	-
384-E11-02-*	✓	5/3 CP	EV37	1200	-0.9-10	2.5-10

U7*x2	KB132000B9x2	S6510 8-1/4	S6520 8-1/4
U7*x2	KB132000B9x2	S6510 8-1/4	S6520 8-1/4
U7*x2	KB132000B9x2	S6510 8-1/4	S6520 8-1/4
U7*x2	KB132000B9x2	S6510 8-1/4	S6520 8-1/4
U7*x2	KB132000B9x2	S6510 8-1/4	S6520 8-1/4
U7*x2	KB132000B9x2	S6510 8-1/4	S6520 8-1/4

*Coil sold separately, see page below for voltage options (U7 Solenoid Coils)

For more connector options, including LED versions please see page 134-137

U7* Solenoid Coils

Solenoid Voltages U7 (Material = PET)			
U7H	24V	50/60 Hz	3.5VA
	12V	DC	3.1W
U7K	110V	AC 50/60Hz	4.3VA
	125V	AC 50/60Hz	5.5VA

Solenoid Voltages U7 (Material = PET)			
U7J	230V	50/60Hz	3.5VA
	240V	50/60Hz	4VA
U77	24V	DC	3W



For full range of solenoid coils please see page 133

3/2 - way single solenoid valve - 1/8 - N.C.

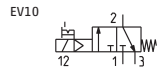
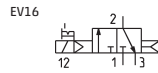

- ✓ Ex Stock
- ✎ UK Assembly
- ☎ Please Call Sales Office

Part Number	Availability	Function	Symbol	Flow Rate (NI/min)	Operating Pressures (Bar)	Minimum Pilot Pressures (Bar)
438-015-22-*	✓	3/2 NC	EV10	650	2.5-10	-
438-016-22-*	✓	3/2 NC	EV16	650	2.5-10	-

*Coil sold separately, see page 116 for voltage options (U7 Solenoid Coils)

ACCESSORIES

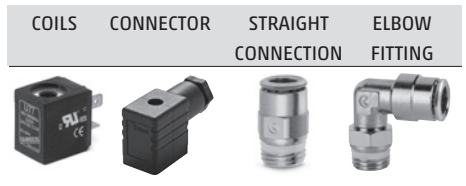

U7*	KB132000B9	S6510 6-1/8	S6520 6-1/8
U7*	KB132000B9	S6510 6-1/8	S6520 6-1/8

For more connector options, including LED versions please see page 134-137

3/2 - way double solenoid valve - 1/8 - N.C.

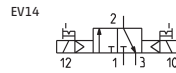

Part Number	Availability	Function	Symbol	Flow Rate (NI/min)	Operating Pressures (Bar)	Minimum Pilot Pressures (Bar)
438-011-22-*	✓	3/2 NC	EV14	650	2-10	-

*Coil sold separately, see page 116 for voltage options (U7 Solenoid Coils)

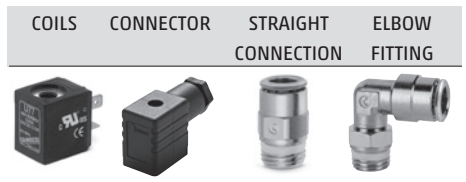

U7*x2	KB132000B9x2	S6510 6-1/8	S6520 6-1/8
-------	--------------	-------------	-------------

For more connector options, including LED versions please see page 134-137

5/2 - way single solenoid valve - 1/8

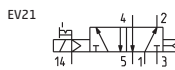
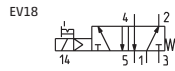

Part Number	Availability	Function	Symbol	Flow Rate (NI/min)	Operating Pressures (Bar)	Minimum Pilot Pressures (Bar)
458-015-22-*	✓	5/2	EV18	650	2.5-10	-
458-016-22-*	✓	5/2	EV21	650	2.5-10	-

*Coil sold separately, see page 116 for voltage options (U7 Solenoid Coils)

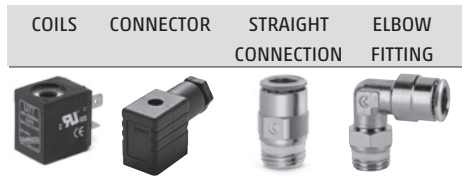

U7*	KB132000B9	S6510 6-1/8	S6520 6-1/8
U7*	KB132000B9	S6510 6-1/8	S6520 6-1/8

For more connector options, including LED versions please see page 134-137

5/2 - way double solenoid valve - 1/8

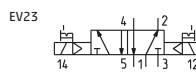

Part Number	Availability	Function	Symbol	Flow Rate (NI/min)	Operating Pressures (Bar)	Minimum Pilot Pressures (Bar)
458-011-22-*	✓	5/2	EV23	650	2-10	-

*Coil sold separately, see page 116 for voltage options (U7 Solenoid Coils)

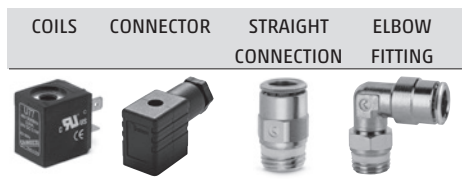

U7*x2	KB132000B9x2	S6510 6-1/8	S6520 6-1/8
-------	--------------	-------------	-------------

For more connector options, including LED versions please see page 134-137

5/3 - way double solenoid valve - 1/8 - C.C.and C.O.

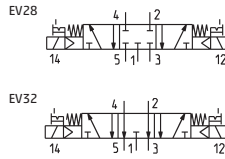

- ✓ Ex Stock
- ✎ UK Assembly
- ☎ Please Call Sales Office

Part Number	Availability	Function	Symbol	Flow Rate (NI/min)	Operating Pressures (Bar)	Minimum Pilot Pressures (Bar)
468-011-22-*	✓	5/3 CC	EV28	600	2-10	-
478-011-22-*	✓	5/3 CO	EV32	600	2-10	-

*Coil sold separately, see page 116 for voltage options (U7 Solenoid Coils)

ACCESSORIES



U7*x2	KB132000B9x2	S6510 6-1/8	S6520 6-1/8
-------	--------------	-------------	-------------

For more connector options, including LED versions please see page 134-137

3/2 - way single solenoid valve - 1/4 - N.C.

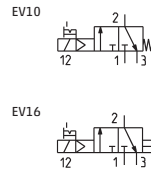

Part Number	Availability	Function	Symbol	Flow Rate (NI/min)	Operating Pressures (Bar)	Minimum Pilot Pressures (Bar)
434-015-22-*	✓	3/2 NC	EV10	1250	2-10	-
434-016-22-*	✓	3/2 NC	EV16	1250	2-10	-

*Coil sold separately, see page 116 for voltage options (U7 Solenoid Coils)



U7*	KB132000B9	S6510 8-1/4	S6520 8-1/4
-----	------------	-------------	-------------

For more connector options, including LED versions please see page 134-137

3/2 - way double solenoid valve - 1/4 - N.C.

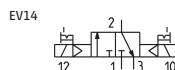

Part Number	Availability	Function	Symbol	Flow Rate (NI/min)	Operating Pressures (Bar)	Minimum Pilot Pressures (Bar)
434-011-22-*	✓	3/2 NC	EV14	1250	2-10	-

*Coil sold separately, see page 116 for voltage options (U7 Solenoid Coils)

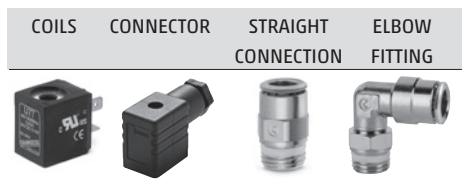

U7*x2	KB132000B9x2	S6510 8-1/4	S6520 8-1/4
-------	--------------	-------------	-------------

For more connector options, including LED versions please see page 134-137

5/2 - way single solenoid valve - 1/4

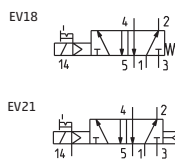

Part Number	Availability	Function	Symbol	Flow Rate (NI/min)	Operating Pressures (Bar)	Minimum Pilot Pressures (Bar)
454-015-22-*	✓	5/2	EV18	1250	2.5-10	-
454-016-22-*	✓	5/2	EV21	1250	2.5-10	-

*Coil sold separately, see page 116 for voltage options (U7 Solenoid Coils)

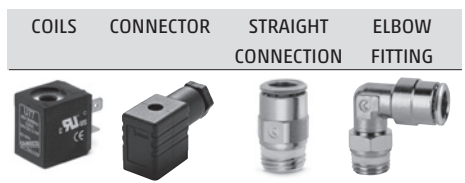

U7*	KB132000B9	S6510 8-1/4	S6520 8-1/4
-----	------------	-------------	-------------

For more connector options, including LED versions please see page 134-137

5/2 - way double solenoid valve - 1/4

- ✓ Ex Stock
- ✎ UK Assembly
- ☎ Please Call Sales Office

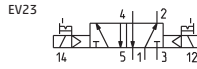

Part Number	Availability	Function	Symbol	Flow Rate (NI/min)	Operating Pressures (Bar)	Minimum Pilot Pressures (Bar)
454-011-22-*	✓	5/2	EV23	1250	2-10	-

*Coil sold separately, see page opposite for voltage options (U7 Solenoid Coils)

ACCESSORIES

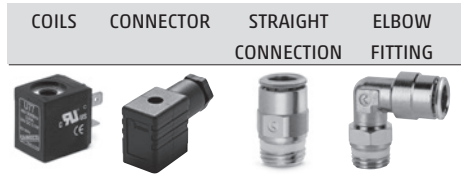

U7*x2 KB132000B9x2 S6510 8-1/4 S6520 8-1/4

For more connector options, including LED versions please see page 134-137

5/2 - way double solenoid valve - 1/4

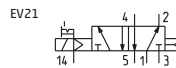

Part Number	Availability	Function	Symbol	Flow Rate (NI/min)	Operating Pressures (Bar)	Minimum Pilot Pressures (Bar)
454-V15-22-*	✓	5/2	EV18	1250	2.5-10	-
454-V16-22-*	✓	5/2	EV21	1250	2.5-10	-

*Coil sold separately, see page opposite for voltage options (U7 Solenoid Coils)



U7* KB132000B9 S6510 8-1/4 S6520 8-1/4

U7* KB132000B9 S6510 8-1/4 S6520 8-1/4

For more connector options, including LED versions please see page 134-137

5/2 - way double vertical solenoid valve - 1/4

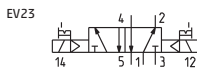

Part Number	Availability	Function	Symbol	Flow Rate (NI/min)	Operating Pressures (Bar)	Minimum Pilot Pressures (Bar)
454-V11-22-*	✓	5/2	EV25	1250	2-10	-

*Coil sold separately, see page opposite for voltage options (U7 Solenoid Coils)



U7*x2 KB132000B9x2 S6510 8-1/4 S6520 8-1/4

For more connector options, including LED versions please see page 134-137

5/3 - way double solenoid valve - 1/4 - C.C. and C.O.

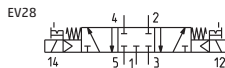

Part Number	Availability	Function	Symbol	Flow Rate (NI/min)	Operating Pressures (Bar)	Minimum Pilot Pressures (Bar)
5/3 way double solenoid valve 1/4 CC and CO						
464-011-22-*	✓	5/3 CC	EV28	1250	3-10	-
474-011-22-*	✓	5/3 CO	EV32	1250	3-10	-

*Coil sold separately, see page opposite for voltage options (U7 Solenoid Coils)

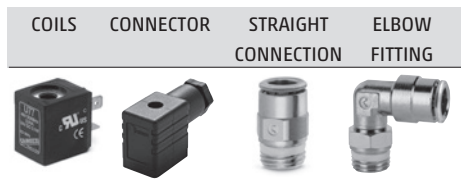

U7*x2 KB132000B9x2 S6510 8-1/4 S6520 8-1/4

U7*x2 KB132000B9x2 S6510 8-1/4 S6520 8-1/4

For more connector options, including LED versions please see page 134-137

3/2 - way solenoid valve - 3/8, monostable

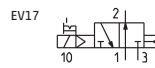
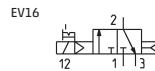
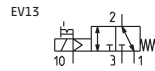
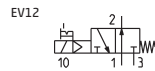
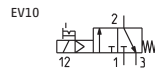
New

- ✓ Ex Stock
- ✎ UK Assembly
- ☎ Please Call Sales Office

Part Number	Availability	Function	Symbol	Flow Rate (NI/min)	Operating Pressures (Bar)	Minimum Pilot Pressures (Bar)
433-015-22	✓	3/2 NC	EV10	1800	2.5-10	-
433-E15-22	✓	3/2	EV13	1800	-0.9-10	2.5
433-016-22	✓	3/2 NC	EV16	1800	2.5-10	-
443-015-22	✓	3/2 NO	EV12	1800	2.5-10	-
443-016-22	✓	3/2 NO	EV17	1800	2.5-10	-

ACCESSORIES

COILS	CONNECTOR	STRAIGHT CONNECTION	ELBOW FITTING
-------	-----------	---------------------	---------------



U7*	KB132000B9	S6510 6-3/8	S6520 6-3/8
U7*	KB132000B9	S6510 6-3/8	S6520 6-3/8
U7*	KB132000B9	S6510 6-3/8	S6520 6-3/8
U7*	KB132000B9	S6510 6-3/8	S6520 6-3/8
U7*	KB132000B9	S6510 6-3/8	S6520 6-3/8

For more connector options, including LED versions please see page 134-137

3/2 - way solenoid valve - 3/8, bistable

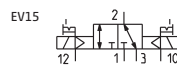
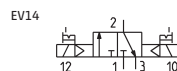
New

Part Number	Availability	Function	Symbol	Flow Rate (NI/min)	Operating Pressures (Bar)	Minimum Pilot Pressures (Bar)
433-011-22	✓	3/2	EV14	1800	2-10	-
433-E11-22	✓	3/2	EV15	1800	-0.9-10	2

ACCESSORIES

COILS	CONNECTOR	STRAIGHT CONNECTION	ELBOW FITTING
-------	-----------	---------------------	---------------



U7*x2	KB132000B9x2	S6510 6-3/8	S6520 6-3/8
U7*x2	KB132000B9x2	S6510 6-3/8	S6520 6-3/8

For more connector options, including LED versions please see page 134-137

5/2 - way solenoid valve - 3/8, monostable

New

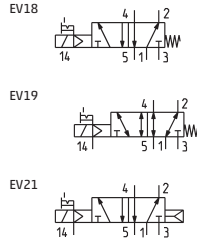

- ✓ Ex Stock
- ✎ UK Assembly
- ☎ Please Call Sales Office

Part Number	Availability	Function	Symbol	Flow Rate (NI/min)	Operating Pressures (Bar)	Minimum Pilot Pressures (Bar)
453-015-22	✓	5/2	EV18	1800	2.5-10	-
453-E15-22	✓	5/2	EV19	1800	-0.9-10	2.5
453-016-22	✓	5/2	EV21	1800	2.5-10	-

ACCESSORIES

COILS	CONNECTOR	STRAIGHT CONNECTION	ELBOW FITTING
-------	-----------	---------------------	---------------



U7*	KB132000B9	S6510 6-3/8	S6520 6-3/8
U7*	KB132000B9	S6510 6-3/8	S6520 6-3/8
U7*	KB132000B9	S6510 6-3/8	S6520 6-3/8

For more connector options, including LED versions please see page 134-137

5/2 - way solenoid valve - 3/8, bistable

New

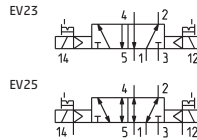

Part Number	Availability	Function	Symbol	Flow Rate (NI/min)	Operating Pressures (Bar)	Minimum Pilot Pressures (Bar)
453-011-22	✓	5/2	EV23	1800	2-10	-
453-E11-22	✓	5/2	EV25	1800	-0.9-10	2

ACCESSORIES

COILS	CONNECTOR	STRAIGHT CONNECTION	ELBOW FITTING
-------	-----------	---------------------	---------------



U7*x2	KB132000B9x2	S6510 6-3/8	S6520 6-3/8
U7*x2	KB132000B9x2	S6510 6-3/8	S6520 6-3/8

For more connector options, including LED versions please see page 134-137

5/3 - way solenoid valve - 3/8

New

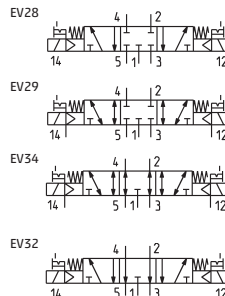

Part Number	Availability	Function	Symbol	Flow Rate (NI/min)	Operating Pressures (Bar)	Minimum Pilot Pressures (Bar)
463-011-22	✓	5/3 CC	EV28	1600	2.5-10	-
463-E11-22	✓	5/3 CC	EV29	1600	-0.9-10	2.5
473-011-22	✓	5/3 CO	EV32	1600	2.5-10	-
473-E11-22	✓	5/3 CO	EV34	1600	-0.9-10	2.5

ACCESSORIES

COILS	CONNECTOR	STRAIGHT CONNECTION	ELBOW FITTING
-------	-----------	---------------------	---------------



U7*x2	KB132000B9x2	S6510 6-3/8	S6520 6-3/8
U7*x2	KB132000B9x2	S6510 6-3/8	S6520 6-3/8

For more connector options, including LED versions please see page 134-137

3/2 and 5/2 - way double solenoid valve - 1/2 - monostable

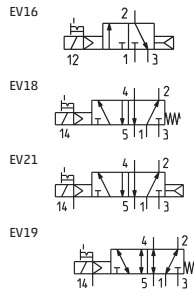

- ✓ Ex Stock
- ✂ UK Assembly
- 📞 Please Call Sales Office

Part Number	Availability	Function	Symbol	Flow Rate (NI/min)	Operating Pressures (Bar)	Minimum Pilot Pressures (Bar)
432C-015-22-*	☉	3/2 NC	EV16	2500	2.5-10	-
452N-015-22-*	☉	5/2	EV18	4000	2.5-10	-
452N-016-22-*	☉	5/2	EV21	4000	2-10	-
452N-E15-22-*	☉	5/2	EV19	4000	-0.9-10	2.5

*Coil sold separately, see page below for voltage options (U7 Solenoid Coils)

ACCESSORIES

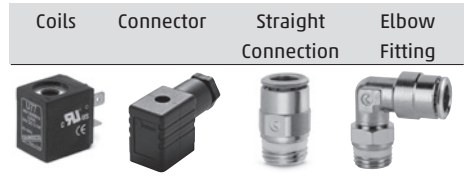

U7*	KB132000B9	S6510 12-1/2	S6520 12-1/2
U7*	KB132000B9	S6510 12-1/2	S6520 12-1/2
U7*	KB132000B9	S6510 12-1/2	S6520 12-1/2
U7*	KB132000B9	S6510 12-1/2	S6520 12-1/2

For more connector options, including LED versions please see page 134-137

3/2 and 5/2 - way solenoid valve - 1/2, bistable

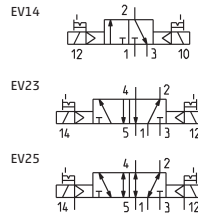

Part Number	Availability	Function	Symbol	Flow Rate (NI/min)	Operating Pressures (Bar)	Minimum Pilot Pressures (Bar)
432C-011-22-*	☉	3/2 NC	EV23			
452N-011-22-*	☉	5/2	EV23	4000	2-10	-
452N-E11-22-*	☉	5/2	EV25	4000	-0.9-10	2

*Coil sold separately, see page below for voltage options (U7 Solenoid Coils)

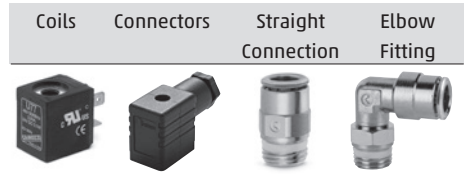

U7*x2	KB132000B9x2	S6510 12-1/2	S6520 12-1/2
U7*x2	KB132000B9x2	S6510 12-1/2	S6520 12-1/2
U7*x2	KB132000B9x2	S6510 12-1/2	S6520 12-1/2

For more connector options, including LED versions please see page 134-137

5/3 - way solenoid valve - 1/2 - bistable

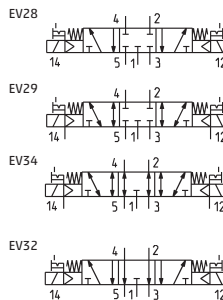

Part Number	Availability	Function	Symbol	Flow Rate (NI/min)	Operating Pressures (Bar)	Minimum Pilot Pressures (Bar)
462N-011-22-*	☉	5/3 CC	EV28	3300	2-10	-
462N-E11-22-*	☉	5/3 CC	EV29	3300	-0.9-10	2
472N-011-22-*	☉	5/3 CO	EV32	3300	2-10	-
472N-E11-22-*	☉	5/3 CO	EV34	3300	-0.9-10	2

*Coil sold separately, see page below for voltage options (U7 Solenoid Coils)

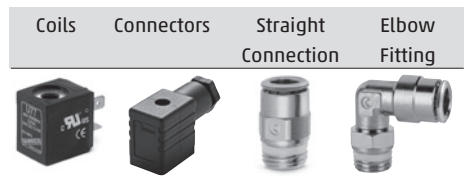

U7*x2	KB132000B9x2	S6510 12-1/2	S6520 12-1/2
U7*x2	KB132000B9x2	S6510 12-1/2	S6520 12-1/2
U7*x2	KB132000B9x2	S6510 12-1/2	S6520 12-1/2
U7*x2	KB132000B9x2	S6510 12-1/2	S6520 12-1/2

For more connector options, including LED versions please see page 134-137

U7* Solenoid Coils

Solenoid Voltages U7 (Material = PET)			
U7H	24V	50/60 Hz	3.5VA
	12V	DC	3.1W
U7K	110V	AC 50/60Hz	4.3VA
	125V	AC 50/60Hz	5.5VA

Solenoid Voltages U7 (Material = PET)			
U7J	230V	50/60Hz	3.5VA
	240V	50/60Hz	4VA
U77	24V	DC	3W



For full range of solenoid coils please see page 133

5/2 - way single solenoid valve - 1/2

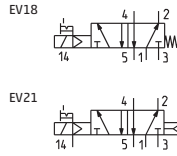

- ✓ Ex Stock
- ✂ UK Assembly
- ☎ Please Call Sales Office

Part Number	Availability	Function	Symbol	Flow Rate (NI/min)	Operating Pressures (Bar)	Minimum Pilot Pressures (Bar)
452C-015-50-A6*	✓	5/2	EV18	2500	2.5-10	-
452C-016-50-A6*	✓	5/2	EV21	2500	2.5-10	-

*Coil included, please state voltage

ACCESSORIES

CONNECTOR	STRAIGHT CONNECTION	ELBOW FITTING

KA132000B9	S6510 12-1/2	S6520 12-1/2
KA132000B9	S6510 12-1/2	S6520 12-1/2

For more connector options, including LED versions please see page 134-137

5/2 - way double solenoid valve - 1/2

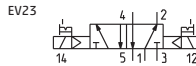

Part Number	Availability	Function	Symbol	Flow Rate (NI/min)	Operating Pressures (Bar)	Minimum Pilot Pressures (Bar)
452C-011-50-A6*	✓	5/2	EV23	2500	2-10	-

*Coil included, please state voltage

CONNECTOR	STRAIGHT CONNECTION	ELBOW FITTING

KA132000B9 x2	S6510 12-1/2	S6520 12-1/2
---------------	--------------	--------------

For more connector options, including LED versions please see page 134-137

CODING EXAMPLE

3	3	8	D	-	015	-	22	-	U	7	7
----------	----------	----------	----------	----------	------------	----------	-----------	----------	----------	----------	----------

3	SERIES: 3 and 4	D	D = double valve (2x3/2) (series 3) L = for manifold assembly (only for 3/2 1/8) (series 3)	U	SOLENOID MATERIAL U = PET G = PA A6 = PPS (series 4 1/2 only) A7 = PPS (series 3 only) A8 = PPS (series 3 only) H8 = PA 6 V0
3	N° OF WAYS/POSITIONS * 3 = 3/2 N.C. * 4 = 3/2 N.O. 5 = 5/2 6 = 5/3 C. closed 7 = 5/3 C. open 8 = 5/3 C. pressure (series 3 only) 9 = 1x 3/2NC + 1x-3/2NO (series 3 only)	015	ACTUATION 011 = double solenoid (horizontal solenoids) V11 = double solenoid (vertical solenoids) (series 4 1/4 only) 015 = single solenoid, spring return (horizontal solenoids) V15 = single solenoid, spring return (vertical solenoid) (series 4 1/4 only) 016 = single solenoid, pneumatic spring return (horizontal solenoid) V16 = single solenoid, pneumatic spring return (vertical solenoid) (series 4 1/4 only) E11 = double solenoid external servo-command (series 3 only) E15 = single solenoid, external servo-command (series 3 only) 015 = single solenoid external servo-command 033 = pneumatic pneumatic 034 = pneumatic differential (series 4 only) 035 = pneumatic spring	7	SOLENOID DIMENSIONS 6 = 32 x 32 only 1/2 7 = 22 x 22 8 = 30 x 30 9 = 22 x 58
8	CONNECTIONS 8 = 1/8 4 = 1/4 2C = 1/2 (series 4 only)	22	SOLENOID INTERFACE 02 = mech. sol. 22 x 22 - (series 3 only) 22 = mech. sol. 22 x 22 - (series 4 only) 50 = mech. sol. 32 x 32 - (series 4 1/2 only)	7	SOLENOID VOLTAGE: See page 133

Series 3 and 4 Pneumatically Operated Valves

Series 3: 1/8, 1/4, 3/2-way and 5/2-way

Series 4: 1/8, 1/4 and 1/2

3/2, 5/2 and 5/3-way

3/2-way valve, 1/8 or 1/4, monostable



- ✓ Ex Stock
- ✎ UK Assembly
- ☎ Please Call Sales Office

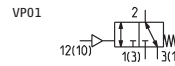

Part Number	Availability	Function	Symbol	Flow Rate (NI/min)	Operating Pressures (Bar)	Connection	Minimum Pilot Pressures (Bar)
338-035	✓	3/2 NC	VP01	700	-0.9-10	1/8	2.5
338L-035**	✓	3/2 NC	VP01	700	-0.9-10	1/8	2.5
334-035*	✓	3/2 NC	VP01	1300	-0.9-10	1/4	3

Pilot supply port = 1/8 (* = M5)

**For Manifold Mounting

Technical Data

Media

Filtered air, without lubrication.
If lubricated air is used, it is recommended to use oil ISO VG32.
Once applied the lubrication should never be interrupted

Operating Temperature

0 - +60°C (with dry air at -20°C)

Full Data Sheet and Dimensions at

<https://store.camozzi.co.uk>

ACCESSORIES

STRAIGHT CONNECTION	ELBOW FITTING	SILENCER

S6510 6-1/8	S6520 6-1/8	2901 1/8
S6510 6-1/8	S6520 6-1/8	2901 1/8
S6510 8-1/4	S6520 8-1/4	2901 1/4-17

3/2-way valve, 1/8 or 1/4, bistable

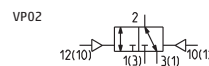

Part Number	Availability	Function	Symbol	Flow Rate (NI/min)	Operating Pressures (Bar)	Connection	Minimum Pilot Pressures (Bar)
338-033	✓	3/2 NC	VP02	700	-0.9-10	1/8	1.5
338L-033**	✓	3/2 NC	VP02	700	-0.9-10	1/8	1.5
334-033*	✓	3/2 NC	VP02	1300	-0.9-10	1/4	2.5

Pilot supply port = 1/8 (* = M5)

**For Manifold Mounting

STRAIGHT CONNECTION	ELBOW FITTING	SILENCER

S6510 6-1/8	S6520 6-1/8	2901 1/8
S6510 6-1/8	S6520 6-1/8	2901 1/8
S6510 8-1/4	S6520 8-1/4	2901 1/4-17

5/2-way valve, 1/8 or 1/4, monostable

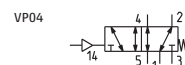

Part Number	Availability	Function	Symbol	Flow Rate (NI/min)	Operating Pressures (Bar)	Connection	Minimum Pilot Pressures (Bar)
358-035	✓	5/2	VP04	700	-0.9-10	1/8	2.5
354-035*	✓	5/2	VP04	1300	-0.9-10	1/4	3

Pilot supply port = 1/8 (* = M5)

STRAIGHT CONNECTION	ELBOW FITTING	SILENCER

S6510 6-1/8	S6520 6-1/8	2901 1/8
S6510 8-1/4	S6520 8-1/4	2901 1/4-17

5/2-way valve, 1/8 or 1/4, bistable



- ✓ Ex Stock
- ✚ UK Assembly
- ☎ Please Call Sales Office

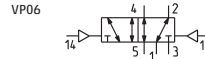

Part Number	Availability	Function	Symbol	Flow Rate (NI/min)	Operating Pressures (Bar)	Connections	Minimum Pilot Pressures (Bar)
358-033	✓	5/2	VP06	700	-0.9-10	1/8	1.5
354-033*	✓	5/2	VP06	1300	-0.9-10	1/4	2.5

Pilot supply port = 1/8 (* = M5)

ACCESSORIES

STRAIGHT CONNECTION	ELBOW FITTING	SILENCER

S6510 6-1/8	S6520 6-1/8	2901 1/8
S6510 8-1/4	S6520 8-1/4	2901 1/4-17

5/3-way valve, 1/8 or 1/4

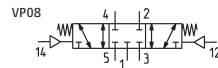

Part Number	Availability	Function	Symbol	Flow Rate (NI/min)	Operating Pressures (Bar)	Connection	Minimum Pilot Pressures (Bar)
368-033	✓	5/3 CC	VP08	700	-0.9-10	1/8	2.5
364-033	✓	5/3 CC	VP08	1200	-0.9-10	1/4	2.5
378-033	✓	5/3 CO	VP09	700	-0.9-10	1/8	2.5
374-033	✓	5/3 CO	VP09	1050	-0.9-10	1/4	2.5
388-033	✓	5/3 CP	VP10	700	-0.9-10	1/8	2.5
384-033	✓	5/3 CP	VP10	1050	-0.9-10	1/4	2.5

Pilot supply port = 1/8

STRAIGHT CONNECTION	ELBOW FITTING	SILENCER

S6510 6-1/8	S6520 6-1/8	2901 1/8
S6510 8-1/4	S6520 8-1/4	2901 1/4-17
S6510 6-1/8	S6520 6-1/8	2901 1/8
S6510 8-1/4	S6520 8-1/4	2901 1/4-17
S6510 6-1/8	S6520 6-1/8	2901 1/8
S6510 6-1/4	S6520 6-1/4	2901 1/4-17

2 x 3/2-way valve, 1/8 or 1/4

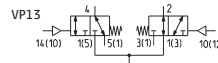
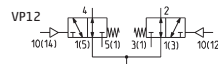
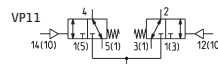

Part Number	Availability	Function	Symbol	Flow Rate (NI/min)	Operating Pressures (Bar)	Connections	Minimum Pilot Pressures (Bar)
338D-035	✓	2x 3/2 NC	VP11	700	-0.9-10	1/8	2.5
334D-035	✓	2x 3/2 NC	VP11	1050	-0.9-10	1/4	2.5
348D-035	✓	2x 3/2 NO	VP12	700	-0.9-10	1/8	2.5
344D-035	✓	2x 3/2 NO	VP12	1050	-0.9-10	1/4	2.5
398D-035	✓	1x3/2 NC + 1x3/2 NO	VP13	700	-0.9-10	1/8	2.5
394D-035	✓	1x3/2 NC + 1x3/2 NO	VP13	1050	-0.9-10	1/4	2.5

Pilot supply port = 1/8

STRAIGHT CONNECTION	ELBOW FITTING	SILENCER

S6510 6-1/8	S6520 6-1/8	2901 1/8
S6510 8-1/4	S6520 8-1/4	2901 1/4-17
S6510 6-1/8	S6520 6-1/8	2901 1/8
S6510 6-1/4	S6520 8-1/4	2901 1/4-17
S6510 6-1/8	S6520 6-1/8	2901 1/8
S6510 8-1/4	S6520 8-1/4	2901 1/4-17

3/2-way valve, 1/8 port, monostable



- ✓ Ex Stock
- ✎ UK Assembly
- 📞 Please Call Sales Office

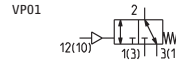

Part Number	Availability	Function	Symbol	Flow Rate (NI/min)	Operating Pressures (Bar)	Connections	Minimum Pilot Pressures (Bar)
438-35	✓	3/2 NC	VP01	700	-0.9-10	1/8	2.5

Pilot supply port = 1/8

ACCESSORIES



S6510 6-1/8	S6520 6-1/8	Z901 1/8
-------------	-------------	----------

5/2-way valve, 1/8 port, monostable

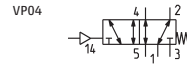

Part Number	Availability	Function	Symbol	Flow Rate (NI/min)	Operating Pressures (Bar)	Connection	Minimum Pilot Pressures (Bar)
458-35	✓	5/2	VP04	700	-0.9-10	1/8	2.5

Pilot supply port = 1/8

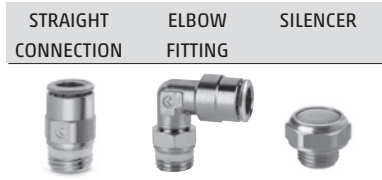

S6510 6-1/8	S6520 6-1/8	Z901 1/8
-------------	-------------	----------

3/2-way valve, 1/8 port, bistable

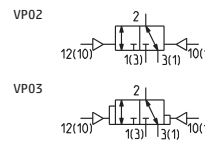

Part Number	Availability	Function	Symbol	Flow Rate (NI/min)	Operating Pressures (Bar)	Connections	Minimum Pilot Pressures (Bar)
438-33	✓	3/2 NC	VP02	700	-0.9-10	1/8	2.5
438-34	✓	3/2 NC	VP03	700	-0.9-10	1/8	2

Pilot supply port = 1/8

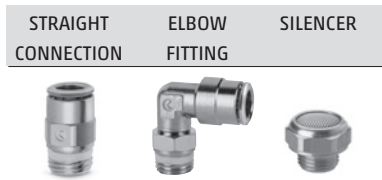

S6510 6-1/8	S6520 6-1/8	Z901 1/8
S6510 6-1/8	S6520 6-1/8	Z901 1/8

5/2-way valve, 1/8 port, bistable

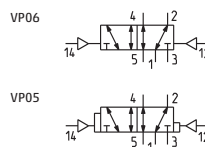

Part Number	Availability	Function	Symbol	Flow Rate (NI/min)	Operating Pressures (Bar)	Connections	Minimum Pilot Pressures (Bar)
458-33	✓	5/2	VP06	700	-0.9-10	1/8	2
458-34	✓	5/2	VP05	700	-0.9-10	1/8	2

Pilot supply port = 1/8

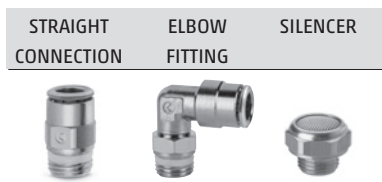

S6510 6-1/8	S6520 6-1/8	Z901 1/8
S6510 6-1/8	S6520 6-1/8	Z901 1/8

5/3-way C.C. valve, 1/8, monostable, with central stable position



- ✓ Ex Stock
- ✎ UK Assembly
- ☎ Please Call Sales Office

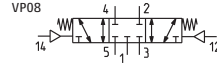

Part Number	Availability	Function	Symbol	Flow Rate (NI/min)	Operating Pressures (Bar)	Connection	Minimum Pilot Pressures (Bar)
468-33	✓	5/3 CC	VP08	700	-0.9-10	1/8	2.5

Pilot supply port = 1/8

ACCESSORIES

STRAIGHT CONNECTION	ELBOW FITTING	SILENCER
S6510 8-1/8	S6520 8-1/8	2901 1/8

3/2-way valve N/C, 1/4 port, monostable

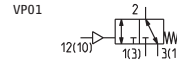

Part Number	Availability	Function	Symbol	Flow Rate (NI/min)	Operating Pressures (Bar)	Connection	Minimum Pilot Pressures (Bar)
434-35	✓	3/2 NC	VP01	1250	-0.9-10	1/4	2.5

Pilot supply port = 1/8

STRAIGHT CONNECTION	ELBOW FITTING	SILENCER
S6510 8-1/4	S6520 8-1/4	2901 1/4-17

5/2-way valve, 1/4 port, monostable

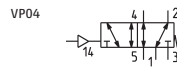

Part Number	Availability	Function	Symbol	Flow Rate (NI/min)	Operating Pressures (Bar)	Connection	Minimum Pilot Pressures (Bar)
454-35	✓	5/2	VP04	1250	-0.9-10	1/4	2.5

Pilot supply port = 1/8

STRAIGHT CONNECTION	ELBOW FITTING	SILENCER
S6510 8-1/4	S6520 8-1/4	2901 1/4-17

3/2-way valve N/C, 1/4 port, bistable

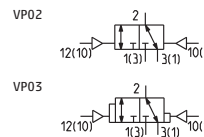

Part Number	Availability	Function	Symbol	Flow Rate (NI/min)	Operating Pressures (Bar)	Connection	Minimum Pilot Pressures (Bar)
434-33	✓	3/2 NC	VP02	1250	-0.9-10	1/4	2
434-34	✓	3/2 NC	VP03	1250	-0.9-10	1/4	2

Pilot supply port = 1/8

STRAIGHT CONNECTION	ELBOW FITTING	SILENCER
S6510 8-1/4	S6520 8-1/4	2901 1/4-17

5/2-way valve, 1/4 port, bistable



- ✓ Ex Stock
- ✚ UK Assembly
- ☎ Please Call Sales Office

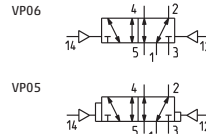

ACCESSORIES

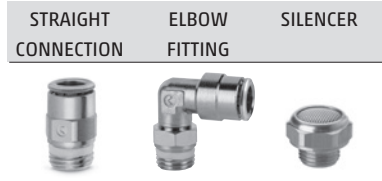

Part Number	Availability	Function	Symbol	Flow Rate (NI/min)	Operating Pressures (Bar)	Connection	Minimum Pilot Pressures (Bar)
454-33	✓	5/2	VP06	1250	-0.9-10	1/4	2
454-34	✓	5/2	VP05	1250	-0.9-10	1/4	2

S6510 8-1/4	S6520 8-1/4	2901 1/4-17
S6510 8-1/4	S6520 8-1/4	2901 1/4-17

Pilot supply port = 1/8

5/3-way CC CO valve, 1/4, monostable, central stable position

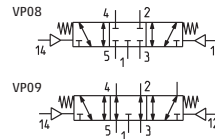

Part Number	Availability	Function	Symbol	Flow Rate (NI/min)	Operating Pressures (Bar)	Connection	Minimum Pilot Pressures (Bar)
464-33	✓	5/3 CC	VP08	1250	-0.9-10	1/4	2.5
474-33	✓	5/3 CO	VP09	1200	-0.9-10	1/4	2.5

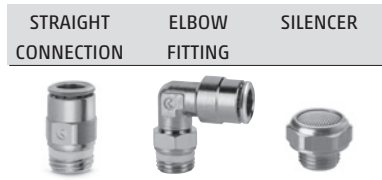

S6510 8-1/4	S6520 8-1/4	2901 1/4-17
S6510 8-1/4	S6520 8-1/4	2901 1/4-17

Pilot supply port = 1/8

3/2-way valve, 3/8 port, monostable

New

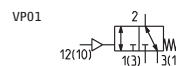

Part Number	Availability	Function	Symbol	Flow Rate (NI/min)	Operating Pressures (Bar)	Connection	Minimum Pilot Pressures (Bar)
433-35	✓	3/2 NC	VP01	1800	-0.9-10	3/8	2.5

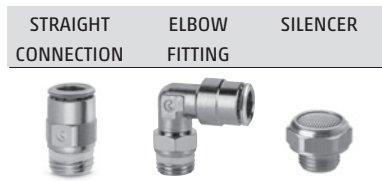

S6510 12-3/8	S6520 12-3/8	2901 3/8
--------------	--------------	----------

Pilot supply port = 1/8

5/2-way valve, 3/8 port, monostable

New

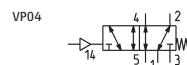

Part Number	Availability	Function	Symbol	Flow Rate (NI/min)	Operating Pressures (Bar)	Connection	Minimum Pilot Pressures (Bar)
453-35	✓	5/2	VP04	1800	-0.9-10	3/8	2.5

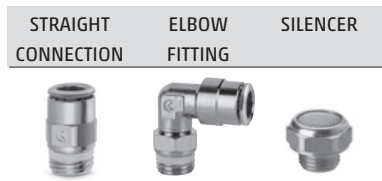

S6510 12-3/8	S6520 12-3/8	2901 3/8
--------------	--------------	----------

Pilot supply port = 1/8

3/2-way valve N/C, 3/8 port, bistable

New



- ✓ Ex Stock
- ✦ UK Assembly
- ☎ Please Call Sales Office

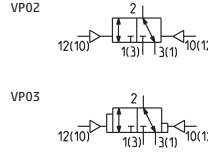

ACCESSORIES



Part Number	Availability	Function	Symbol	Flow Rate (NI/min)	Operating Pressures (Bar)	Connection	Minimum Pilot Pressures (Bar)
433-33	✓	3/2 NC	VP02	1800	-0.9-10	3/8	2
433-34	✓	3/2 NC	VP03	1800	-0.9-10	3/8	2

S6510 12-3/8	S6520 12-3/8	2901 3/8
S6510 12-3/8	S6520 12-3/8	2901 3/8

Pilot supply port = 1/8

5/2-way valve, 3/8 port, bistable

New

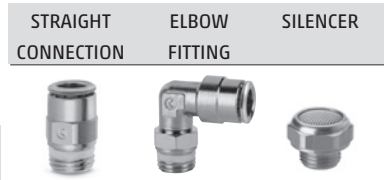
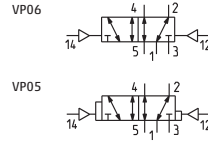

Part Number	Availability	Function	Symbol	Flow Rate (NI/min)	Operating Pressures (Bar)	Connection	Minimum Pilot Pressures (Bar)
453-33	✓	5/2	VP06	1800	-0.9-10	3/8	2
453-34	✓	5/2	VP05	1800	-0.9-10	3/8	2

S6510 12-3/8	S6520 12-3/8	2901 3/8
S6510 12-3/8	S6520 12-3/8	2901 3/8

Pilot supply port = 1/8

5/2-way valve, 1/2 port, monostable

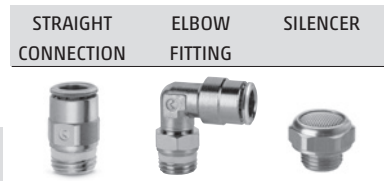
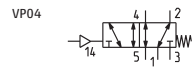

Part Number	Availability	Function	Symbol	Flow Rate (NI/min)	Operating Pressures (Bar)	Connection	Minimum Pilot Pressures (Bar)
452C-35	✓	5/2	VP04	2500	-0.9-10	1/2	2.5

S6510 12-1/2	S6520 12-1/2	2901 1/2
--------------	--------------	----------

Pilot supply port = 1/8

5/2-way valve, 1/2 port, bistable

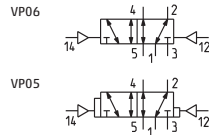

ACCESSORIES

STRAIGHT CONNECTION	ELBOW FITTING	SILENCER
---------------------	---------------	----------



Part Number	Availability	Function	Symbol	Flow Rate (NI/min)	Operating Pressures (Bar)	Connection	Minimum Pilot Pressures (Bar)
452C-33	✓	5/2	VP06	2500	-0.9-10	1/2	2
452C-34	✓	5/2	VP05	2500	-0.9-10	1/2	2

S6510 12-1/2	S6520 12-1/2	2901 1/2
S6510 12-1/2	S6520 12-1/2	2901 1/2

Pilot supply port = 1/8

5/2-way valve, 1/2 port, monostable



- ✓ Ex Stock
- ✎ UK Assembly
- Ⓞ Please Call Sales Office

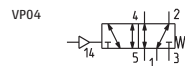

STRAIGHT CONNECTION	ELBOW FITTING	SILENCER
---------------------	---------------	----------



Part Number	Availability	Function	Symbol	Flow Rate (NI/min)	Operating Pressures (Bar)	Connection	Minimum Pilot Pressures (Bar)
452N-35	Ⓞ	5/2	VP04	4000	-0.9-10	1/2	2.5

S6510 12-1/2	S6520 12-1/2	2901 1/2
--------------	--------------	----------

Pilot supply port = 1/8

5/2-way valve, 1/2 port, bistable

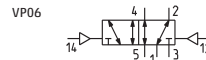

STRAIGHT CONNECTION	ELBOW FITTING	SILENCER
---------------------	---------------	----------



Part Number	Availability	Function	Symbol	Flow Rate (NI/min)	Operating Pressures (Bar)	Connections	Minimum Pilot Pressures (Bar)
452N-33	Ⓞ	5/2	VP06	4000	-0.9-10	1/2	2

S6510 12-1/2	S6520 12-1/2	2901 1/2
--------------	--------------	----------

Pilot supply port = 1/8

CODING EXAMPLE

3	5	8	-	035
3	SERIES: 3, 4	8	CONNECTIONS 8 = 1/8 4 = 1/4 2C = 1/2	
5	N° OF WAYS/POSITIONS 3 = 3/2 5 = 5/2 6 = 5/3 C.C. 7 = 5/3 C.O.	035	ACTUATION/RETURN 033 = pneumatic / pneumatic (series 3) 33 = pneumatic / pneumatic (series 4) 34 = pneumatic / differential (series 4) 35 = pneumatic / spring (series 4) 035 = pneumatic / spring (series 3)	

Series 3 Modular Manifolds - 1/8 and 1/4

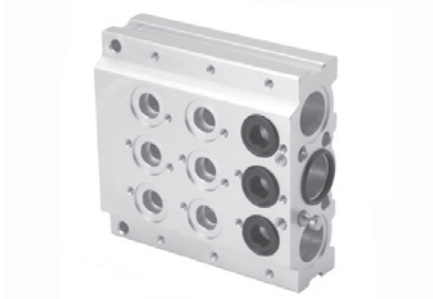





- ✓ Ex Stock
- ✎ UK Assembly
- ☎ Please Call Sales Office

Part Number	Availability	G	
Basic Module		3 Station	
CNVL-3H3	✓	to suit Series 3, 1/8	3/8
CNVL-4H3	✓	to suit Series 3, 1/4	1/2

The packaging contains: 3 O-rings, 2 Fixing Screws and 2 Junction Plugs per station.



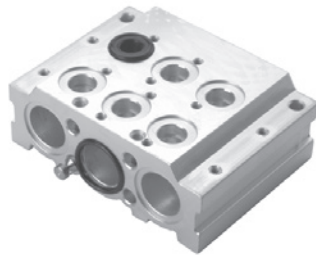

ACCESSORIES

STRAIGHT CONNECTION	ELBOW FITTING	SILENCER	MALE PLUG
			
S6510 10-3/8	S6520 10-3/8	2901 3/8	S2610-3/8
S6510 12-1/2	S6520 12-1/2	2901 1/2	S2610-1/2



Part Number	Availability	G	
Basic Module		2 Station	
CNVL-3H2	✓	to suit Series 3, 1/8	3/8
CNVL-4H2	✓	to suit Series 3, 1/4	1/2

The packaging contains: 3 O-rings, 2 Fixing Screws and 2 Junction Plugs per station.

STRAIGHT CONNECTION	ELBOW FITTING	SILENCER	MALE PLUG
			
S6510 10-3/8	S6520 10-3/8	2901 3/8	S2610-3/8
S6510 12-1/2	S6520 12-1/2	2901 1/2	S2610-1/2



Part Number	Availability		
Expansion Module		3 Station	
CNVL-3I3	✓	to suit Series 3, 1/8	
CNVL-4I3	✓	to suit Series 3, 1/4	

The packaging contains: 3 O-rings, 2 Fixing Screws and 2 Junction Plugs per station.



Part Number	Availability		
Expansion Module		2 Station	
CNVL-3I2	✓	to suit Series 3, 1/8	
CNVL-4I2	✓	to suit Series 3, 1/4	

The packaging contains: 3 O-rings, 2 Fixing Screws and 2 Junction Plugs per station.

Series 3 Modular Manifolds - 1/8 and 1/4

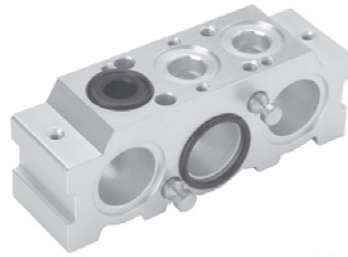



- ✓ Ex Stock
- ✚ UK Assembly
- ☎ Please Call Sales Office

Part Number	Availability	
Expansion Module		1 Station
CNVL-311	✓	to suit Series 3, 1/8
CNVL-411	✓	to suit Series 3, 1/4

The packaging contains: 3 O-rings, 2 Fixing Screws and 2 Junction Plugs per station.



ACCESSORIES

STRAIGHT CONNECTION	ELBOW FITTING	SILENCER
		
S6510 10-3/8	S6520 10-3/8	2901 3/8
S6510 12-1/2	S6520 12-1/2	2901 1/2

Part Number	Availability		G
Terminal Module			
CNVL-3H	✓	to suit Series 3, 1/8	3/8
CNVL-4H	✓	to suit Series 3, 1/4	1/2

The packaging contains: 2 Junction Plugs per station.

More Than Just Pneumatics

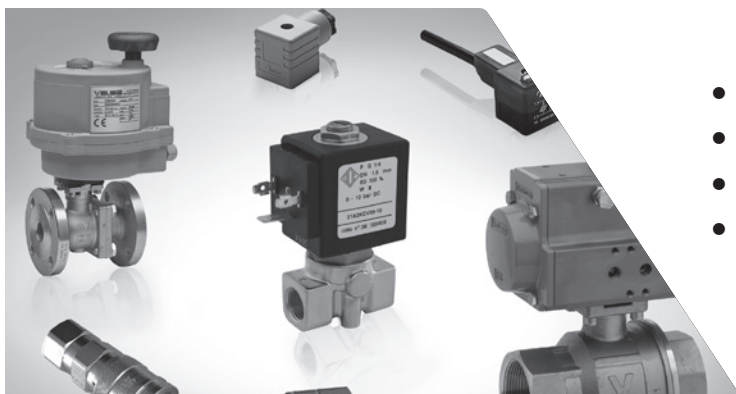

- Process Valves and Actuators
- Hydraulic Components
- Solenoid DIN Connectors
- Industrial Solenoid Valves

Accessories

- ✓ Ex Stock
- ✎ UK Assembly
- ☎ Please Call Sales Office

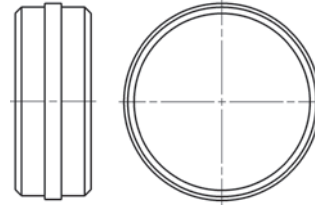
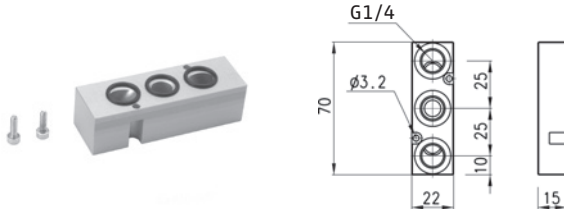

Intermediate plate for manifolds with outlets	Availability
---	--------------

CNVL-3P	✓
CNVL-4P	✓

The packaging contains: 3 O-rings and 2 Fixing Screws.

Part Number	Availability
-------------	--------------

Diaphragm	
CNVL-3H-TP	✓
CNVL-4H-TP	✓

Code for Plug-in Versions

T	Supply (1) + exhaust (3 and 5)
U	Supply (1)
J	Exhausts (3 and 5)

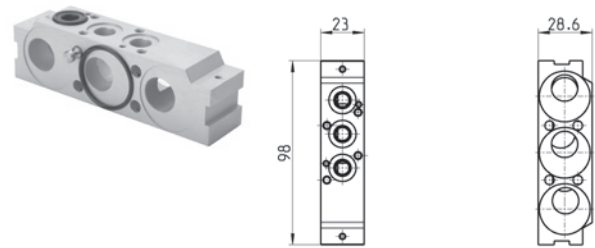
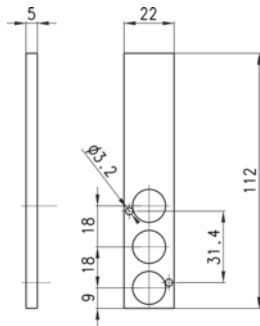

Excluder	Availability
----------	--------------

CNVL/1L Code L	✓
-----------------------	---

The packaging contains: 3 O-rings and 2 Fixing Screws.

Interface Module Manifolds	Availability
----------------------------	--------------

between 1/4 and 1/8 (Series 3)	
CNVL-4H-3H	✓

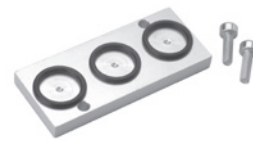

Part Number: CNVL/1 Part Number: CNVL/2 Part Number: CNVL/3

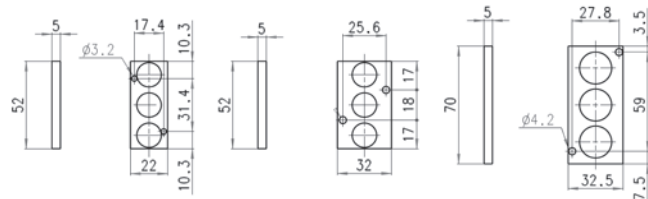
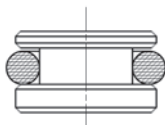

Blanking Plug for CNVL... Manifolds. For use with 3/2 - way valves	Availability
--	--------------

TCNVL/3 for 1/8	✓
TCNVL/5 for 1/4	✓

Blanking Plate for Manifolds with outlets	Availability
---	--------------

CNVL/1 For Series 3 - 1/8	✓
CNVL/2 For Series 4 - 1/8	✓
CNVL/3 For Series 4 - 1/4	✓
CNVL/4 For Series 3 - 1/4	✓

Series 9 Electropneumatically and Pneumatically Operated Valves

Assembly with sub-base (ISO 5599/1 Standards)

Connection: 1/4 (size 1), 3/8 (size 2), 1/2 (size 3)

5/2 and 5/3 way CC CO



5/2-way solenoid valves, monostable - ISO 1, ISO 2, ISO 3



- ✓ Ex Stock
- ✚ UK Assembly
- ☎ Please Call Sales Office

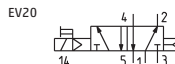
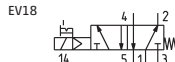

Technical Data

Media

Filtered air, without lubrication.

Operating Temperature

0°C to +60°C

(with dry air -20°C)

Full Data Sheet and Dimensions at
<https://store.camozzi.co.uk>

ACCESSORIES

SOLENOID COILS



CONNECTOR



Part Number	Availability	Function	Symbol	Flow Rate (NI/min)	Operating Pressures (Bar)
951-000-P15-23-*	✓	5/2	EV18	900	2.5-10
952-000-P15-23-*	✓	5/2	EV18	1610	2.5-10
953-000-P15-23-*	✓	5/2	EV18	4350	2.5-10
951-000-P16-23-*	✓	5/2	EV20	900	2.5-10
952-000-P16-23-*	✓	5/2	EV20	1610	2.5-10
953-000-P16-23-*	✓	5/2	EV20	4350	2.5-10

*Coil sold separately, see page 133 for voltage options (U7 Solenoid Coils)

SOLENOID COILS	CONNECTOR
U7*	KB132000B9
U7*	KB132000B9
U7*	KB132000B9
U7*	KB132000B9
U7*	KB132000B9
U7*	KB132000B9

For more connector options, including LED versions please see page 134-137

5/2-way, 5/3-way (CO,CC) solenoid valves, bistable - ISO 1, ISO 2, ISO 3

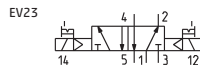

Part Number	Availability	Function	Symbol	Flow Rate (NI/min)	Operating Pressures (Bar)
951-000-P11-23*	✓	5/2	EV23	900	2.5-10
952-000-P11-23*	✓	5/2	EV23	1610	2.5-10
953-000-P11-23*	✓	5/2	EV23	4350	2.5-10
961-000-P11-23*	✓	5/3 CC	EV28	900	2.5-10
962-000-P11-23*	✓	5/3 CC	EV28	1610	2.5-10
963-000-P11-23*	✓	5/3 CC	EV28	4350	2.5-10
971-000-P11-23*	✓	5/3 CO	EV32	900	2.5-10
972-000-P11-23*	✓	5/3 CO	EV32	1610	2.5-10
973-000-P11-23*	✓	5/3 CO	EV32	4350	2.5-10

*Coil sold separately, see page 133 for voltage options (U7 Solenoid Coils)

ACCESSORIES

SOLENOID COILS



CONNECTOR



SOLENOID COILS	CONNECTOR
U7* x2	KB132000B9 x2
U7* x2	KB132000B9 x2
U7* x2	KB132000B9 x2
U7* x2	KB132000B9 x2
U7* x2	KB132000B9 x2
U7* x2	KB132000B9 x2
U7* x2	KB132000B9 x2
U7* x2	KB132000B9 x2
U7* x2	KB132000B9 x2
U7* x2	KB132000B9 x2

For more connector options, including LED versions please see page 134-137

5/2-way valves, monostable, bistable - ISO 1, ISO 2, ISO 3



- ✓ Ex Stock
- ✎ UK Assembly
- ☎ Please Call Sales Office

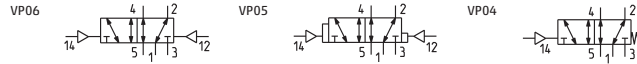

Part Number	Availability	Function	Symbol	Flow Rate (NI/min)	Working Pressures (Bar)	Minimum Pilot Pressures (Bar)	ISO Size
951-000-33	✓	5/2	VP06	900	-0.9-10	2	1
952-000-33	✓	5/2	VP06	1610	-0.9-10	2	2
953-000-33	✓	5/2	VP06	4350	-0.9-10	2	3
951-000-34	✓	5/2	VP05	900	-0.9-10	2	1
952-000-34	✓	5/2	VP05	1610	-0.9-10	2	2
953-000-34	✓	5/2	VP05	4350	-0.9-10	2	3
951-000-35	✓	5/2	VP04	900	-0.9-10	2.5	1
952-000-35	✓	5/2	VP04	1610	-0.9-10	2.5	2
953-000-35	✓	5/2	VP04	4350	-0.9-10	2.5	3

5/3-way valve (CC,CO) monostable, with stable central position - ISO 1, 2, 3

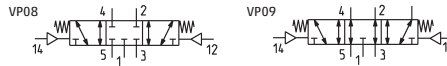

Part Number	Availability	Function	Symbol	Flow Rate (NI/min)	Working Pressures (Bar)	Minimum Pilot Pressures (Bar)	ISO Size
961-000-33	✓	5/3 CC	VP08	900	-0.9-10	2-5	1
962-000-33	✓	5/3 CC	VP08	1610	-0.9-10	2-5	2
963-000-33	✓	5/3 CC	VP08	4350	-0.9-10	2-5	3
971-000-33	✓	5/3 CO	VP09	900	-0.9-10	2-5	1
972-000-33	✓	5/3 CO	VP09	1610	-0.9-10	2-5	2
973-000-33	✓	5/3 CO	VP09	4350	-0.9-10	2-5	3

CODING EXAMPLE

9 | **5** | **1** | - | **000** | - | **P16** | - | **P16** | - | **23** | - | **U7** | **7**

9	SERIES: 9	P16	ACTUATION: 33 = pneumatic, pneumatic return 34 = pneumatic, differential pneumatic return 35 = pneumatic, mechanical spring return P11 = double solenoid (horizontal solenoids) P15 = single solenoid, spring return (horizontal solenoids) P16 = solenoid, pneumatic spring return (horizontal solenoids)	U7	SOLENOID MATERIAL / SOLENOID DIMENSIONS: A8 = PPS / 30 x 30 G7 = PA / 22 x 22 G8 = PA / 30 x 30 (24 V DC only) G9 = PA / 22 x 58 H8 = PA 6 V0 / 30 x 30 U7 = PET / 22 x 22
5	NO OF WAYS/POSITIONS: 5 = 5/2 6 = 5/3 CC 7 = 5/3 CO				
1	SIZE: 1 = Size 1 2 = Size 2 3 = Size 3			7	SOLENOID VOLTAGE: See solenoids page 133
000	BODY DESIGN: 000 = valve body	23	SOLENOID INTERFACE: 23 = A531 - BC2 Cnorm norm		

Complete with two end-blocks Part Number 90-H** or 90*-HN*.

Single sub-base side outlets (VDM A 24345)



- ✓ Ex Stock
- ✚ UK Assembly
- ☎ Please Call Sales Office

Part Number	Availability	Size
901-F1A	✓	1
902-F2A	✓	2
903-F3A	✓	3

Single sub-base with rear outlets (VDM A 24345)

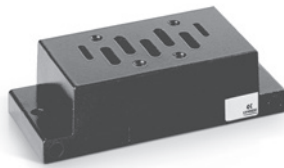

Part Number	Availability	Size
901-G1A	✓	1
902-G2A	✓	2
903-G3A	✓	3

Manifold sub-base with com. exhausts and inlet (VDM A 24345)



Part Number	Availability	Size
901-C1A	✓	1
902-C2A	✓	2
903-C3A	✓	3

End block for manifold sub-base (VDM A 24345)





Part Number	Availability	Size
901-H1*	✓	1
902-H1*	✓	2
903-H1*	✓	3

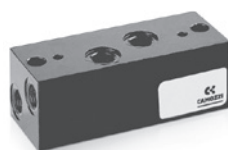

Interface with front outlets (VDM A 24345)









Part Number	Availability	Size
901-N1	✓	1
902-N2	✓	2
903-N3	✓	3



ACCESSORIES

STRAIGHT CONNECTION	ELBOW FITTING	SILENCER
		
S6510 8-1/4	S6520 8-1/4	2901 1/4-17
S6510 10-3/8	S6520 10-3/8	2901 3/8
S6510 12-1/2	S6520 12-1/2	2901 1/2

STRAIGHT CONNECTION	ELBOW FITTING	SILENCER
		
S6510 8-1/4	S6520 8-1/4	2901 1/4-17
S6510 10-3/8	S6520 10-3/8	2901 3/8
S6510 12-1/2	S6520 12-1/2	2901 1/2

STRAIGHT CONNECTION	ELBOW FITTING	SILENCER
		
S6510 8-1/4	S6520 8-1/4	2901 1/4-17
S6510 10-3/8	S6520 10-3/8	2901 3/8
S6510 12-1/2	S6520 12-1/2	2901 1/2

STRAIGHT CONNECTION	ELBOW FITTING	SILENCER
		
S6510 8-1/4	S6520 8-1/4	2901 1/4-17
S6510 10-3/8	S6520 10-3/8	2901 3/8
S6510 12-1/2	S6520 12-1/2	2901 1/2

STRAIGHT CONNECTION	ELBOW FITTING	SILENCER
		
S6510 8-1/4	S6520 8-1/4	2901 1/4-17
S6510 10-3/8	S6520 10-3/8	2901 3/8
S6510 12-1/2	S6520 12-1/2	2901 1/2

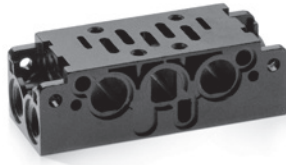

Manifold bases with comm. inlet and exhaust ports and front outlet



- ✓ Ex Stock
- 🔧 UK Assembly
- 📞 Please Call Sales Office

Part Number	Availability	Size
901-N1A	✓	1



ACCESSORIES

INLET FITTING	CONNECTOR	STRAIGHT CONNECTION
		
S6510 8-1/4	S6520 8-1/4	Z901 1/4-17

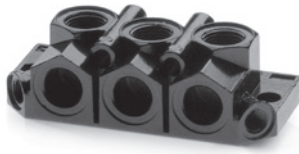
End blocks for manifold bases with front outlets



Part Number	Availability	Size
901-HN1	✓	1

INLET FITTING	CONNECTOR	STRAIGHT CONNECTION
		
S6510 10-3/8	S6520 10-3/8	

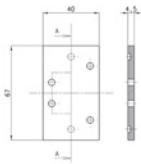

Cover Plate for Unused Positions
901-TP



Mounting
901-C1A-TP
902-C2A-TP



Separation Joint
901-N1A-T



Separation Joint
901-N1A/TP

Series NA NAMUR Valves

Connection: 1/4

Electropneumatically and pneumatically operated 3/2, 5/2, 5/3 way with interface according to NAMUR standard

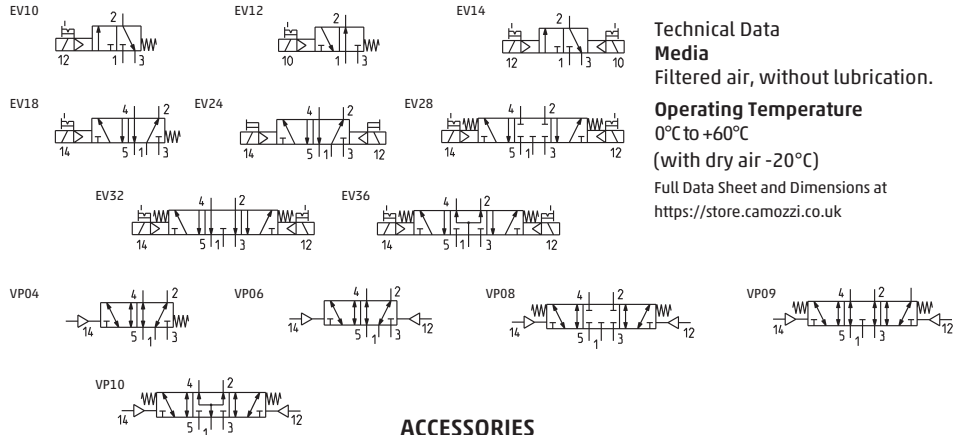

Technical Data

Media

Filtered air, without lubrication.

Operating Temperature

0°C to +60°C

(with dry air -20°C)

Full Data Sheet and Dimensions at

<https://store.camozzi.co.uk>

- ✓ Ex Stock
- ✎ UK Assembly
- ☎ Please Call Sales Office

Part Number	Availability	Function	Symbol	Flow Rate (NI/min)	Operating Pressures (Bar)	Minimum Pilot Pressures (Bar)
NA34N-15-02-*	✓	3/2	EV10	1000	2-10	-
NA44N-15-02-*	✓	3/2 NO	EV12	1000	2-10	-
NA54N-15-02-*	✓	5/2	EV18	1000	2-10	-
NA34N-11-02-*	✓	3/2 NC	EV24	1000	1-10	-
NA54N-11-02-*	✓	5/2	EV24	1000	1-10	-
NA64N-11-02-*	✓	5/3 CC	EV28	1000	1.5-10	-
NA74N-11-02-*	✓	5/3 CO	EV32	1000	1.5-10	-
NA84N-11-02-*	✓	5/3 CP	EV36	1000	1.5-10	-
NA54N-33	✓	5/2	VP06	1000	-0.9-10	2.5
NA54N-35	✓	5/2	VP04	1000	-0.9-10	2.5
NA64N-33	✓	5/3 CC	VP08	1000	-0.9-10	2.5
NA74N-33	✓	5/3 CO	VP09	1000	-0.9-10	2.5
NA84N-33	✓	5/3 CP	VP10	1000	-0.9-10	2.5

*Coil sold separately, see page 133 for voltage options (U7 Solenoid Coils)

ACCESSORIES

Coils	Connector	Silencer	Straight Connection	Elbow Fitting
-------	-----------	----------	---------------------	---------------



U7*	KB132000B9	2901 1/4-17	S6510 6-1/4	S6520 6-1/4
U7*	KB132000B9	2901 1/4-17	S6510 6-1/4	S6520 6-1/4
U7*	KB132000B9	2901 1/4-17	S6510 6-1/4	S6520 6-1/4
U7*x2	KB132000B9x2	2901 1/4-17	S6510 6-1/4	S6520 6-1/4
U7*x2	KB132000B9x2	2901 1/4-17	S6510 6-1/4	S6520 6-1/4
U7*x2	KB132000B9x2	2901 1/4-17	S6510 6-1/4	S6520 6-1/4
U7*x2	KB132000B9x2	2901 1/4-17	S6510 6-1/4	S6520 6-1/4
U7*x2	KB132000B9x2	2901 1/4-17	S6510 6-1/4	S6520 6-1/4
-	-	2901 1/4-17	S6510 6-1/4	S6520 6-1/4
-	-	2901 1/4-17	S6510 6-1/4	S6520 6-1/4
-	-	2901 1/4-17	S6510 6-1/4	S6520 6-1/4
-	-	2901 1/4-17	S6510 6-1/4	S6520 6-1/4
-	-	2901 1/4-17	S6510 6-1/4	S6520 6-1/4

For more connector options, including LED versions please see page 134-137

CODING EXAMPLE

NA	5	4N	15	02	U	7	7
NA SERIES: NAMUR				U SOLENOID MATERIAL U = PET H = Self-extinguishing nylon Explosion-proof (30 x 30)* G = PA * on request			
5 N° N° WAY/POSITIONS 3 = 3/2 4 = 3/2 N.A. 5 = 5/2 6 = 5/3 C.C. 7 = 5/3 C.O. 8 = 5/3 pressure centres PC	15 ACTUATION 11 = double solenoid 15 = single solenoid spring return 33 = pneumatic / pneumatic 35 = pneumatic / spring			7 SOLENOID DIMENSIONS 7 = 22 x 22 8 = 30 x 30 9 = 22 x 22 with memory			
4N CONNECTIONS 4 = 1/4 supply NAMUR Standards	02 SOLENOID INTERFACE 02 = mech. sol. 22 x 22			7 SOLENOID VOLTAGE: See page 133			

U7* - U7*EX - G7* - A8* - G93 - B* - H8 and GP* Solenoid Coils

Solenoids for electropneumatically operated valves Series A-3-4-9-NA
Version A and B
Connection according to DIN 43650 and DIN 40050 standards

Solenoids Mod. U7... / U7*EX

- ✓ Ex Stock
- ✦ UK Assembly
- ⊙ Please Call Sales Office



Solenoids Mod. G7...



Solenoid Voltages U7 (Material = PET)				
	Availability	Solenoid Voltage		Power Absorption
U7H	✓	24V	50/60 Hz	3.5VA
	✓	12V	DC	3.1W
U7K	✓	110V	50/60Hz	3.8VA
	✓	125V	50/60Hz	5.5VA
U7J	✓	230V	50/60Hz	3.5VA
	✓	240V	50/60Hz	4VA
U79	✓	48V	DC	3.1W
U710	✓	110V	DC	3.2W
U77	✓	24V	DC	3.1W
	✓	48V	50/60Hz	3.5VA
U7F	✓	380V	50/60Hz	7VA
U72	✓	12V	DC	5W
U73	✓	24V	DC	5W

For use with all Camozzi valves with the exception of Series 4 (1/2"), and Series 6.

Solenoid Voltages G7 (Material = PA)				
	Availability	Solenoid Voltage		Power Absorption
G7H	⊙	24V	50/60 Hz	3.5VA
	⊙	12V	DC	3.1W
G7K	⊙	110V	AC 50/60Hz	4.3VA
	⊙	125V	AC 50/60Hz	5.5VA
G7J	⊙	230V	50/60Hz	3.5VA
	⊙	240V	50/60Hz	4VA
G79	⊙	48V	DC	3.1W
G710	⊙	110V	DC	3.2W
G77	⊙	24V	DC	3.1W
	⊙	48V	50/60Hz	3.5VA
G72	⊙	12V	DC	5W
G73	⊙	24V	DC	5W

For use with all Camozzi valves with the exception of Series 4 (1/2"), and Series 6.

Solenoids Mod. A8...



Solenoid Voltages A8 (Bipolar plus earth)			
	Availability	Solenoid Voltage	Power Absorption
A8B	⊙	24V - 50/60 Hz	5VA
A8D	⊙	110V - 50/60 Hz	5VA
A8E	⊙	220V - 50/60Hz	5VA
A83	⊙	24V - DC	4W

For use with all Camozzi valves with the exception of Series 4 (1/2") and Series 6.

Solenoids Mod. G93 (with memory)



Solenoid Voltages G90 (with memory for pulsed operation)		
	Availability	Solenoid Voltage
G93	⊙	24V

For Use with all Camozzi valves with the exception of Series 4 (1/2") and Series 6.

Solenoids Mod. B7...

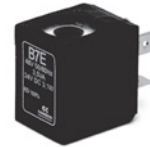

Solenoid Voltages B7 (Bipolar plus earth)			
	Availability	Solenoid Voltage	Power Absorption
B7B	⊙	24 V - 50/60 Hz	9 VA
B7D	⊙	110 V - 50/60 Hz	9 VA
B7E	⊙	230 V - 50/60 Hz	9 VA
B72	⊙	12 V - DC	10 W
B73	⊙	24 V - DC	10 W

For use with all Camozzi valves with the exception of Series 4 (1/2") and Series 6.

Solenoids Mod. B8...

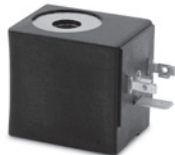

Solenoid Voltages B8 (Bipolar plus earth)			
	Availability	Solenoid Voltage	Power Absorption
B8B/B8BK	⊙	24 V - 50 Hz	15 VA
B8D/B8DK	⊙	110 V - 50/60 Hz	15 VA
B8E/B8EK	⊙	230 V - 50/60 Hz	15 VA
B82/B82K	⊙	12 V - DC	19 W
B83/B83K	⊙	24 V - DC	19 W

For use with all Camozzi valves with the exception of Series 4 (1/2") and Series 6.

Solenoids Mod. B9...



Solenoid Voltages B9 (Bipolar plus earth)			
	Availability	Solenoid Voltage	Power Absorption
B9B	⊙	24 V - 50 Hz	29 VA
B9D	⊙	110 V - 50/60 Hz	29 VA
B9E	⊙	230 V - 50 Hz	29 VA
B93	⊙	24 V - DC	30 W

For use with all Camozzi valves with the exception of Series 4 (1/2") and Series 6.

Solenoids Mod. GP...

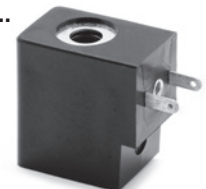

Solenoid Voltages GP (Bipolar plus earth)			
	Availability	Solenoid Voltage	Power Absorption
GPB	⊙	12 V DC	3W
GP7	⊙	24 V DC	3W

For use with all Camozzi valves with the exception of Series 4 (1/2") and Series 6.

Explosion proof coils available on request

Solenoid DIN Connectors

With cable gland entry and conforming to EN175301-803 (Formerly DIN43650)
The Camozzi range of DIN connectors with cable gland entry offers flexibility and are suitable for a wide variety of applications.

Form A (18mm pin spacing)

Also available with flat gasket.

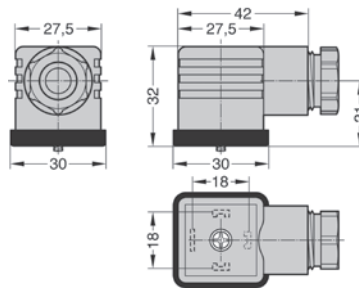
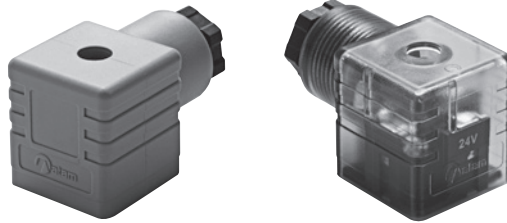

- ✓ Ex Stock
- ✎ UK Assembly
- ☎ Please Call Sales Office

Form A (18mm pin spacing)		Type	Cable
Part Number	Availability	(LED Voltage AC/DC)	Entry
KA132000B9	✓	Black Connector	PG9
KA132000A9	✓	Grey Connector	PG9
KA042000B9	✓	Black Connector (3+E)	PG9
KA042000A9	✓	Grey Connector (3+E)	PG9
KA132T54T9	✓	Transparent (24V LED)	PG9
KA132V55T9	✓	Transparent (115V LED)	PG9
KA132V56T9	✓	Transparent (230V LED)	PG9

Use with Camozzi Series 4 valves - 1/2, Series 6 and A80 coils

Industrial Form B (11mm pin spacing)

Also available with flat gasket.

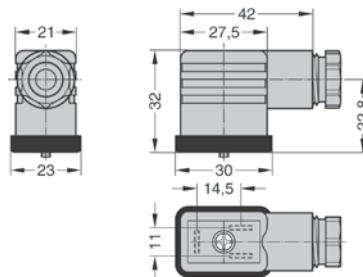

- ✓ Ex Stock
- ✎ UK Assembly
- ☎ Please Call Sales Office

Industrial Form B (11mm pin spacing)		Type	Cable
Part Number	Availability	(LED Voltage AC/DC)	Entry
KB132000B9	✓	Black Connector	PG9
KB132V54T9	✓	Transparent (24V LED)	PG9
KB132V55T9	✓	Transparent (115V LED)	PG9
KB132V56T9	✓	Transparent (230V LED)	PG9

Use with Camozzi Series A, Series AP, Series 3, Series 4 ISO valves and NAMUR valves

Technical Data

Type
Connector with cable gland entry: standard, mini and micro
Operating Temperature
-40°C to +90°C.

Materials

Connectors: Polyamide (glass fibre reinforced)
Profile gasket: NBR standard (Form A and B)
Flat gasket: NBR standard (Form C)
Screw: Form A and B - M3 x 32mm
Industrial Form C - M3 x 28mm
Form C - M2.5 x 28mm

Insulation Group

VDE 0110 1/89 - Class C

Voltage

Up to 250V AC or DC unless otherwise stated

Other voltages available on request

Current

10A (nominal) 16A (max) - Form A and B

6A (nominal) 10A (max) - Form C

Contact Resistance

≤4m Ω

Protection Rating

IP65 (when correctly assembled with fixing screw and gasket supplied)

Cable Gland Size

PG7 cable diameter 4 - 6mm

PG9 cable diameter 6 - 8mm

LED Circuit Function

Where an LED is required, the standard control circuit contains an amber bipolar LED to confirm supply voltage, and VDR (varistor) which protects the supply and load from over voltage.

The circuit can be used for AC or DC supply at the stated voltage

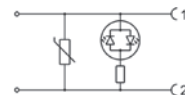

Options

LED in red or green

Additional control circuit functions available.

Gaskets in profile or flat Form.

For solenoid connectors with moulded cable, see pages 136-137
For proximity switches, see page 45

Special Requests

For assistance, contact our technical office or your local Camozzi distributor.

Industrial Form C (9.4mm pin spacing)

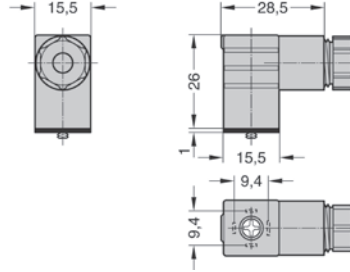
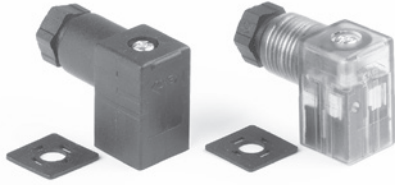

- ✓ Ex Stock
- ✎ UK Assembly
- ⊗ Please Call Sales Office

Industrial Form C (9.4mm pin spacing)		Type	Cable
Part Number	Availability	(LED Voltage AC/DC)	Entry
KD136000B7	✓	Black Connector	PG7
KD136V54T7	✓	Transparent (24V LED)	PG7
KD136V55T7	✓	Transparent (115V LED)	PG7
KD136V56T7	✓	Transparent (230V LED)	PG7

Use with Camozzi Series E and P valves

Technical Data

Type

Connector with cable gland entry: standard, mini and micro

Operating Temperature
-40°C to +90°C

Materials

Connectors: Polyamide (glass fibre reinforced)
Profile gasket: NBR standard (Form A and B)
Flat gasket: NBR standard (Form C)
Screw: Form A and B - M3 x 32.5mm
Industrial Form C - M3 x 27.5mm
Form C - M2.5 x 27.5mm

Insulation Group

VDE 0110 1/89 - Class C

Voltage

Up to 250V AC or DC unless otherwise stated

Other voltages available on request

Current

10A (nominal) 16A (max) - Form A and B

6A (nominal) 10A (max) - Form C

Contact Resistance

≤ 4mΩ

Protection Rating

IP65 (when correctly assembled with fixing screw and gasket supplied)

Cable Gland Size

PG7 cable diameter 4 - 6mm

PG9 cable diameter 6 - 8mm

LED Circuit Function

Where an LED is required, the standard control circuit contains an amber bipolar LED to confirm supply voltage, and VDR (varistor) which protects the supply and load from over voltage.

The circuit can be used for AC or DC supply at the stated voltage

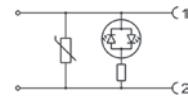

Form C (8mm pin spacing)

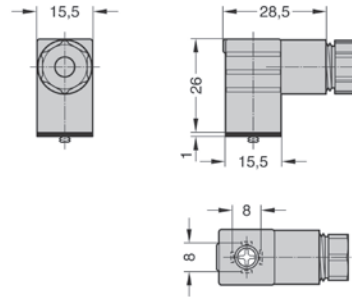
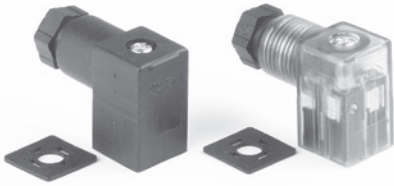

- ✓ Ex Stock
- ✎ UK Assembly
- ⊗ Please Call Sales Office

Form C (8mm pin spacing)		Type	Cable
Part Number	Availability	(LED Voltage AC/DC)	Entry
KC136000B7	✓	Black Connector	PG7
KC136V54T7	✓	Transparent (24V LED)	PG7
KC136V55T7	⊗	Transparent (115V LED)	PG7
KC136V56T7	⊗	Transparent (230V LED)	PG7

Use with Camozzi Series W valves

Solenoid Connectors

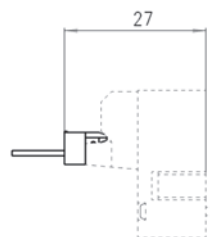
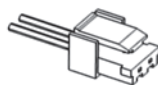

- ✓ Ex Stock
- ✎ UK Assembly
- ⊗ Please Call Sales Office

Part Number	Availability	
121-803	✓	with 300 mm cable
121-806	✓	with 600 mm cable
121-810	✓	with 1000 mm cable

Use with Camozzi Series K and Series E (size 10.5mm) valves

Options

LED in red or green

Additional control circuit functions available.

Gaskets in profile or flat Form.

For solenoid connectors with moulded cable, see pages 136-137

For proximity switches, see page 45

Special Requests

For assistance, contact our technical office or your local Camozzi distributor.

Solenoid DIN Connectors - with Moulded Cable

Moulded cable assemblies EN175301-803 (Formerly DIN43650)

The Camozzi range of DIN moulded cable connectors offers a fast and efficient method of connection, resulting in reduced installation time and cost.

Form A (18mm pin spacing) Double Earth

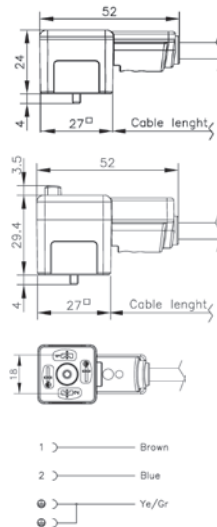

- ✓ Ex Stock
- ✍ UK Assembly
- ☎ Please Call Sales Office

Form A (18mm pin spacing) Double Earth		Type	Cable Length
Part Number	Availability	(LED Voltage AC/DC)	
MA134000PA05100	✓	Cable Connector only	1M
MA134000PA05300	✓	Cable Connector only	3M
MA634V54PA05100	☎	Cable Connector (24V LED)	1M
MA634V54PA05300	✓	Cable Connector (24V LED)	3M
MA634V55PA05100	☎	Cable Connector (115V LED)	1M
MA634V55PA05300	☎	Cable Connector (115V LED)	3M
MA634V56PA05100	☎	Cable Connector (230V LED)	1M
MA634V56PA05300	☎	Cable Connector (230V LED)	3M

Use with Camozzi Series 4 valves - 1/2, series 6 and A80 coils

Industrial Form B (11mm Pin Spacing) 12 O'Clock Earth

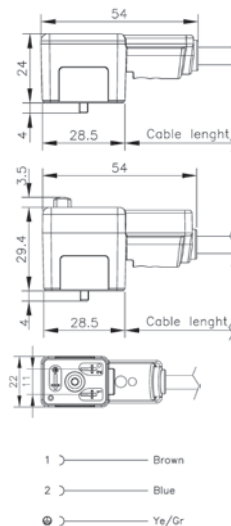

- ✓ Ex Stock
- ✍ UK Assembly
- ☎ Please Call Sales Office

Industrial Form B (11mm Pin Spacing) 12 O'Clock Earth		Type	Cable Length
Part Number	Availability	(LED Voltage AC/DC)	
MB135000PA05100	✓	Cable Connector only	1M
MB135000PA05300	✓	Cable Connector only	3M
MB635V54PA05100	✓	Cable Connector (24V LED)	1M
MB635V54PA05300	✓	Cable Connector (24V LED)	3M
MB635V55PA05100	☎	Cable Connector (115V LED)	1M
MB635V55PA05300	☎	Cable Connector (115V LED)	3M
MB635V56PA05100	☎	Cable Connector (230V LED)	1M
MB635V56PA05300	☎	Cable Connector (230V LED)	3M

Use with Camozzi Series A, series AP, series 3, series 4 and ISO valves - 1/2, series 6 and A80 coils

Technical Data

Type

Moulded cable connectors: Standard, mini and micro

Operating Temperature

-40°C to +90°C

Materials

Connectors: TPU

Cable: PVC standard

Integrated gasket: TPU

Screw: Form A and B (with LED) - M3 x 28.5mm. Form A and B (non LED) - M3 x 25mm

Industrial Form C M3 x 23mm

Form C M2.5 x 23mm

Insulation Group

VDE 0110 1/89 - Class C

Voltage

Up to 250V AC or DC unless otherwise stated

Other voltages available on request

Current

5A - Form A and B

3A - Form C

Contact Resistance

≤4mΩ

Protection Rating

IP67

Standard Cable

3 x 0.75mm² conductors PVC H05 VVF

(Form A and B)

3 x 0.50mm² conductors PVC H03 VVF

(Form C)

LED Circuit Function

Where an LED is required, the standard control circuit contains an amber bipolar LED to confirm supply voltage, and VDR (varistor) which protects the supply and load from over voltage.

The circuit can be used for AC or DC supply at the stated voltage.

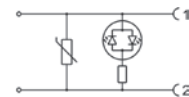

Options

Additional cable types and lengths.

LED in red or green. Additional control circuit functions available.

For solenoid connectors with cable gland entry, pages 134-135.

For proximity switches, see page 45

Special Requests

For assistance, contact our technical office or your local Camozzi distributor.

Industrial Form B (11mm pin spacing) 6 O'Clock Earth

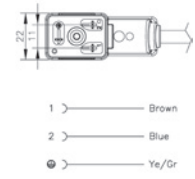
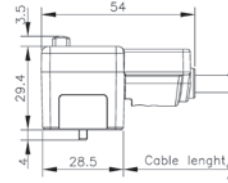
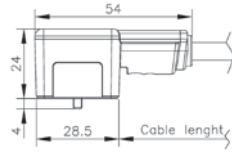

- ✓ Ex Stock
- 🔧 UK Assembly
- 📞 Please Call Sales Office

Industrial Form B (11mm pin spacing) 6 O'Clock Earth		Type	Cable
Part Number	Availability	(LED Voltage AC/DC)	Length
MB136000PA05100	🕒	Cable Connector only	1M
MB136000PA05300	✓	Cable Connector only	3M
MB636V54PA05100	🕒	Cable Connector (24V LED)	1M
MB636V54PA05300	🕒	Cable Connector (24V LED)	3M
MB636V55PA05100	🕒	Cable Connector (115V LED)	1M
MB636V55PA05300	🕒	Cable Connector (115V LED)	3M
MB636V56PA05100	🕒	Cable Connector (230V LED)	1M
MB636V56PA05300	🕒	Cable Connector (230V LED)	3M

Use with Camozzi Series A, series AP, Series 3, Series 4 and ISO valves and NAMUR Valves

Technical Data

Type

Moulded cable connectors: Standard, mini and micro

Operating Temperature
-40°C to +90°C.

Materials

Connectors: TPU
Cable: PVC standard
Integrated gasket: TPU
Screw: Form A and B (with LED) - M3 x 28.5mm. Form A and B (non LED) - M3 x 25mm

Industrial Form C M3 x 23mm
Form C M2.5 x 23mm

Insulation Group

VDE 0110 1/89 - Class C

Voltage

Up to 250V AC or DC unless otherwise stated
Other voltages available on request

Current

5A - Form A and B
3A - Form C

Contact Resistance

≤4mΩ

Protection Rating

IP67

Standard Cable

3 x 0.75mm² conductors PVC H05 VVF (Form A and B)
3 x 0.50mm² conductors PVC H03 VVF (Form C)

LED Circuit Function

Where an LED is required, the standard control circuit contains an amber bipolar LED to confirm supply voltage, and VDR (varistor) which protects the supply and load from over voltage.

The circuit can be used for AC or DC supply at the stated voltage.

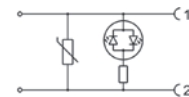

Options

Additional cable types and lengths. LED in red or green. Additional control circuit functions available. For solenoid connectors with cable gland entry, pages 134-135. For proximity switches, see page 45

Special Requests

For assistance, contact our technical office or your local Camozzi distributor.

Industrial Form C (9.4mm pin spacing) Double Earth

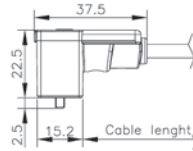
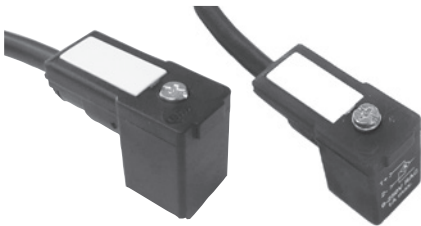

Industrial Form C (9.4mm pin spacing) Double Earth		Type	Cable
Part Number	Availability	(LED Voltage AC/DC)	Length
MD134000PA01100	🕒	Cable Connector only	1M
MD134000PA01300	✓	Cable Connector only	3M
MD634V54TA01100	✓	Cable Connector (24V LED)	1M
MD634V54TA01300	✓	Cable Connector (24V LED)	3M
MD634V55TA01100	🕒	Cable Connector (115V LED)	1M
MD634V55TA01300	🕒	Cable Connector (115V LED)	3M
MD634V56TA01100	🕒	Cable Connector (230V LED)	1M
MD634V56TA01300	🕒	Cable Connector (230V LED)	3M

Use with Camozzi Series E, and Series P valves

Industrial Form C (8mm pin spacing) Double Earth

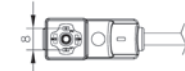
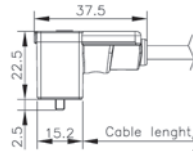
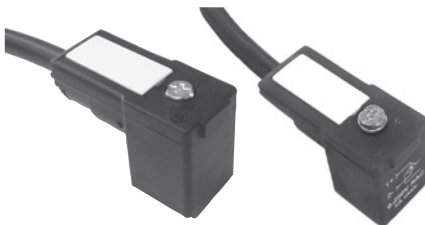

Industrial Form C (8mm pin spacing) Double Earth		Type	Cable
Part Number	Availability	(LED Voltage AC/DC)	Length
MC134000PA01100	🕒	Cable Connector only	1M
MC134000PA01300	✓	Cable Connector only	3M
MC634V54TA01100	🕒	Cable Connector (24V LED)	1M
MC634V54TA01300	🕒	Cable Connector (24V LED)	3M
MC634V55TA01100	🕒	Cable Connector (115V LED)	1M
MC634V55TA01300	🕒	Cable Connector (115V LED)	3M
MC634V56TA01100	🕒	Cable Connector (230V LED)	1M
MC634V56TA01300	🕒	Cable Connector (230V LED)	3M

Use with Camozzi Series W valves

Series 2 Mechanically Operated Minivalves

3/2 NC & NO

Connections: M5, ø4mm cartridge

Minivalves with plunger, 3/2 NC & NO



- ✓ Ex Stock
- ✎ UK Assembly
- ☎ Please Call Sales Office

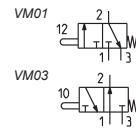

ACCESSORIES

	STRAIGHT CONNECTION	ELBOW FITTING
235-945	6512 4-M5	6522 4-M5
234-945	-	-
245-945	6512 4-M5	6522 4-M5
244-945	-	-

Minivalves with plunger, panel mounting, 3/2 NC & NO

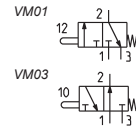

	STRAIGHT CONNECTION	ELBOW FITTING
235-985	6512 4-M5	6522 4-M5
234-985	-	-
245-985	6512 4-M5	6522 4-M5
244-985	-	-

Minivalves with lever/roller, 3/2 NC & NO

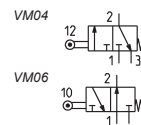

	STRAIGHT CONNECTION	ELBOW FITTING
235-955	6512 4-M5	6522 4-M5
234-955	-	-
245-955	6512 4-M5	6522 4-M5
244-955	-	-

Part Number	Availability	Connection	Function	Symbol	Flow Rate (NI/min)	Operating Pressures (Bar)	Actuating Force*
Plunger							
235-945	✓	M5	3/2 NC	VM01	60	2-8	6N
234-945	✓	4mm	3/2 NC	VM01	60	2-8	6N
245-945	✓	M5	3/2 NO	VM03	60	2-8	6N
244-945	✓	4mm	3/2 NO	VM03	60	2-8	6N
Panel Mounted Plunger							
235-985	✓	M5	3/2 NC	VM01	60	2-8	6N
234-985	✓	4mm	3/2 NC	VM01	60	2-8	6N
245-985	✓	M5	3/2 NO	VM03	60	2-8	6N
244-985	✓	4mm	3/2 NO	VM03	60	2-8	6N
Roller Lever							
235-955	✓	M5	3/2 NC	VM04	100	0-10	6N
234-955	✓	4mm	3/2 NC	VM04	100	0-10	6N
245-955	✓	M5	3/2 NO	VM06	100	0-10	6N
244-955	✓	4mm	3/2 NO	VM06	100	0-10	6N

Minivalves, unidirectional lever, 3/2 NC & NO



- ✓ Ex Stock
- ✎ UK Assembly
- ☎ Please Call Sales Office

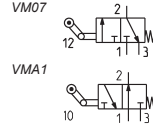

ACCESSORIES

STRAIGHT CONNECTION	ELBOW FITTING
6512 4-M5	6522 4-M5
-	-
6512 4-M5	6522 4-M5
-	-

Part Number	Availability	Connection	Function	Symbol	Flow Rate (NI/min)	Operating Pressures (Bar)	Actuating Force*
One-Way Trip							
235-965	✓	M5	3/2 NC	VM07	60	2-10	6N
234-965	✓	4mm	3/2 NC	VM07	60	2-10	6N
245-965	✓	M5	3/2 NO	VMA1	60	2-10	6N
244-965	✓	4mm	3/2 NO	VMA1	60	2-10	6N

CODING EXAMPLE

2	3	4	-	94	5
2	SERIES: 2				
3	FUNCTION: 3 = 3/2-way NC 4 = 3/2-way NO on request		94	ACTUATION: 94 = plunger 95 = roller/lever 96 = unidirectional lever 98 = plunger, panel mounting	
4	CONNECTIONS: 4 = Ø4mm cartridge 5 = M5		5	RESETTING: 5 = Spring return	

CAD Drawings

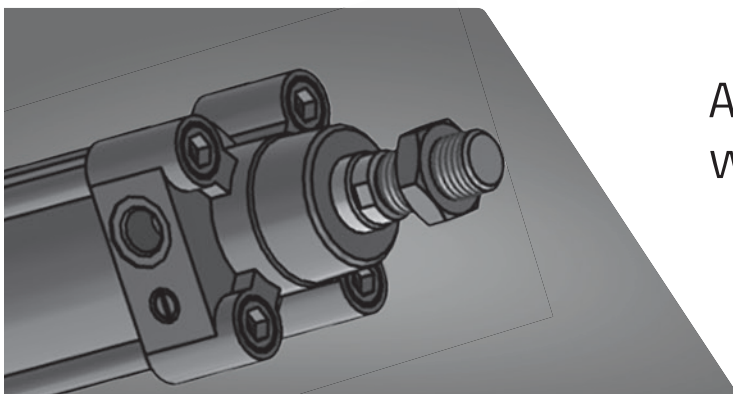

Access CAD models at:
www.camozzi.co.uk

Series 1 and 3 Mechanically Operated Valves

Series 1, 3/2-way and 5/2-way Connections: 1/8 and 1/4

Series 3, 3/2-way and 5/2-way Connections: 1/8

Valve 338-945, 3/2 NC

- ✓ Ex Stock
- ✚ UK Assembly
- ☎ Please Call Sales Office

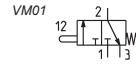

Part Number	Availability	Connection	Function	Symbol	Flow Rate (NI/min)	Operating Pressures (Bar)	Actuating Force*
338-945	✓	1/8	3/2 NC	VM01	700	-0.9-10	32N

*Actuating force at 6 Bar

ACCESSORIES

STRAIGHT CONNECTION	ELBOW FITTING	SILENCER
S6510 6-1/8	S6520 6-1/8	2901 1/8

Valve 358-945, 5/2

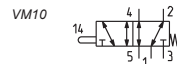

Part Number	Availability	Connection	Function	Symbol	Flow Rate (NI/min)	Operating Pressures (Bar)	Actuating Force*
358-945	✓	1/8	5/2	VM10	700	-0.9-10	35N

*Actuating force at 6 Bar

STRAIGHT CONNECTION	ELBOW FITTING	SILENCER
S6510 6-1/8	S6520 6-1/8	2901 1/8

Valve 338-955, 3/2 NC

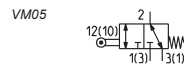

Part Number	Availability	Connection	Function	Symbol	Flow Rate (NI/min)	Operating Pressures (Bar)	Actuating Force*
338-955	✓	1/8	3/2 NC	VM05	700	-0.9-10	15N

*Actuating force at 6 Bar

STRAIGHT CONNECTION	ELBOW FITTING	SILENCER
S6510 6-1/8	S6520 6-1/8	2901 1/8

Valve 358-955, 5/2

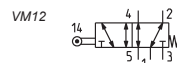

Part Number	Availability	Connection	Function	Symbol	Flow Rate (NI/min)	Operating Pressures (Bar)	Actuating Force*
358-955	✓	1/8	5/2	VM12	700	-0.9-10	17N

*Actuating force at 6 Bar

STRAIGHT CONNECTION	ELBOW FITTING	SILENCER
S6510 6-1/8	S6520 6-1/8	2901 1/8

Valve 338-965, 3/2 NC

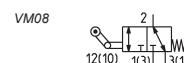

Part Number	Availability	Connection	Function	Symbol	Flow Rate (NI/min)	Operating Pressures (Bar)	Actuating Force*
338-965	✓	1/8	3/2 NC	VM08	700	-0.9-10	15N

*Actuating force at 6 Bar

STRAIGHT CONNECTION	ELBOW FITTING	SILENCER
S6510 6-1/8	S6520 6-1/8	2901 1/8

Valve 358-965, 5/2



- ✓ Ex Stock
- 🔧 UK Assembly
- ☎ Please Call Sales Office

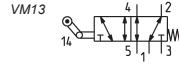

Part Number	Availability	Connection	Function	Symbol	Flow Rate (NI/min)	Operating Pressures (Bar)	Actuating Force*
358-965	✓	1/8	5/2	VM13	700	-0.9-10	16N

*Actuating force at 6 Bar

ACCESSORIES

STRAIGHT CONNECTION	ELBOW FITTING	SILENCER
S6510 6-1/8	S6520 6-1/8	2901 1/8

Valve 138-945, 3/2 NC



Part Number	Availability	Connection	Function	Symbol	Flow Rate (NI/min)	Operating Pressures (Bar)	Actuating Force*
138-945	✓	1/8	3/2 NC	VM01	500	0-10	70N

*Actuating force at 6 Bar

STRAIGHT CONNECTION	ELBOW FITTING	SILENCER
S6510 6-1/8	S6520 6-1/8	2901 1/8

Valve 148-945, 3/2 NO

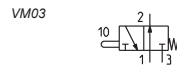

Part Number	Availability	Connection	Function	Symbol	Flow Rate (NI/min)	Operating Pressures (Bar)	Actuating Force*
148-945	✓	1/8	3/2 NO	VM03	500	0-10	70N

*Actuating force at 6 Bar

STRAIGHT CONNECTION	ELBOW FITTING	SILENCER
S6510 6-1/8	S6520 6-1/8	2901 1/8

Valve Mod. 158-945, 5/2

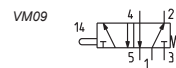

Part Number	Availability	Connection	Function	Symbol	Flow Rate (NI/min)	Operating Pressures (Bar)	Actuating Force*
158-945	✓	1/8	5/2	VM09	500	0-10	120N

*Actuating force at 6 Bar

STRAIGHT CONNECTION	ELBOW FITTING	SILENCER
S6510 6-1/8	S6520 6-1/8	2901 1/8

Valve Mod. 138-955, 3/2 NC

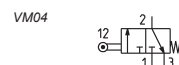

Part Number	Availability	Connection	Function	Symbol	Flow Rate (NI/min)	Operating Pressures (Bar)	Actuating Force*
138-955	✓	1/8	3/2 NC	VM04	500	0-10	36N

*Actuating force at 6 Bar

STRAIGHT CONNECTION	ELBOW FITTING	SILENCER
S6510 6-1/8	S6520 6-1/8	2901 1/8

Valve 158-955, 5/2

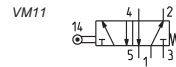

- ✓ Ex Stock
- ✎ UK Assembly
- 📞 Please Call Sales Office

Part Number	Availability	Connection	Function	Symbol	Flow Rate (NI/min)	Operating Pressures (Bar)	Actuating Force*
158-955	✓	1/8	5/2	VM11	500	0-10	92N

*Actuating force at 6 Bar

ACCESSORIES

STRAIGHT CONNECTION	ELBOW FITTING	SILENCER
S6510 6-1/8	S6520 6-1/8	2901 1/8

Valve 138-965, 3/2 NC



Part Number	Availability	Connection	Function	Symbol	Flow Rate (NI/min)	Operating Pressures (Bar)	Actuating Force*
138-965	✓	1/8	3/2 NC	VM07	500	0-10	41N

*Actuating force at 6 Bar

STRAIGHT CONNECTION	ELBOW FITTING	SILENCER
S6510 6-1/8	S6520 6-1/8	2901 1/8

Valve 134-945, 3/2 NC

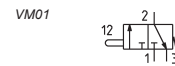

Part Number	Availability	Connection	Function	Symbol	Flow Rate (NI/min)	Operating Pressures (Bar)	Actuating Force*
134-945	✓	1/4	3/2 NC	VM01	1250	0-10	64N

*Actuating force at 6 Bar

STRAIGHT CONNECTION	ELBOW FITTING	SILENCER
S6510 8-1/4	S6520 8-1/4	2901 1/4-17

Valve 154-945, 5/2

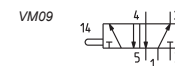

Part Number	Availability	Connection	Function	Symbol	Flow Rate (NI/min)	Operating Pressures (Bar)	Actuating Force*
154-945	✓	1/4	5/2	VM09	1250	0-10	147N

*Actuating force at 6 Bar

STRAIGHT CONNECTION	ELBOW FITTING	SILENCER
S6510 8-1/4	S6520 8-1/4	2901 1/4-17

Valve 134-955, 3/2 NC

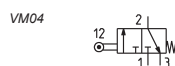

Part Number	Availability	Connection	Function	Symbol	Flow Rate (NI/min)	Operating Pressures (Bar)	Actuating Force*
134-955	✓	1/4	3/2 NC	VM04	1250	0-10	41N

*Actuating force at 6 Bar

STRAIGHT CONNECTION	ELBOW FITTING	SILENCER
S6510 8-1/4	S6520 8-1/4	2901 1/4-17



Valve 154-955, 5/2

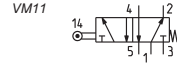

- ✓ Ex Stock
- ✎ UK Assembly
- ☎ Please Call Sales Office



ACCESSORIES

STRAIGHT CONNECTION	ELBOW FITTING	SILENCER
		
S6510 8-1/4	S6520 8-1/4	2901 1/4-17

Part Number	Availability	Connection	Function	Symbol	Flow Rate (Nl/min)	Operating Pressures (Bar)	Actuating Force*
154-955	✓	1/4	5/2	VM11	1250	0-10	110N

*Actuating force at 6 Bar

CODING EXAMPLE

3	3	8	-	94	5
3	SERIES: 1, 3				
3	FUNCTION: 3 = 3/2 way N.C. 4 = 3/2 way N.O. (only Series 1) 5 = 5/2 way		94	ACTUATION: 94 = plunger 95 = roller/lever 96 = unidirectional roller/lever	
8	CONNECTIONS: 8 = 1/8 4 = 1/4 (only Series 1)		5	RESETTING: 5 = spring return	

UK Online Store



Request an account today

- Instantly check price and availability
- Download product datasheets
- Place orders whenever it suits you

<https://store.camozzi.co.uk>

Series 3 and 4 Mechanically Operated Sensor Valves

3/2 and 5/2

Connections: 1/8, 1/4

Valve Mod. 338-D15-9A5, 3/2 NC

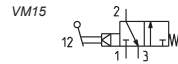

- ✓ Ex Stock
- ✂ UK Assembly
- 📞 Please Call Sales Office



Part Number	Availability	Connection	Function	Symbol	Flow Rate (NI/min)	Operating Pressures (Bar)	Actuating Force*
338-D15-9A5	✓	1/8	3/2 NC	VM15	700	4-10	2N

*Actuating force at 6 Bar

ACCESSORIES

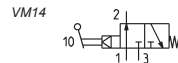

Straight Connection	Elbow Fitting	Silencer
		
S6510 6-1/8	S6520 6-1/8	Z901 1/8

Valve Mod. 348-D15-9A5, 3/2 NO



Part Number	Availability	Connection	Function	Symbol	Flow Rate (NI/min)	Operating Pressures (Bar)	Actuating Force*
348-D15-9A5	✓	1/8	3/2 NO	VM14	700	4-10	2N

*Actuating force at 6 Bar

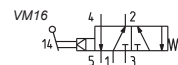

Straight Connection	Elbow Fitting	Silencer
		
S6510 6-1/8	S6520 6-1/8	Z901 1/8

Valve Mod. 358-D15-9A5, 5/2



Part Number	Availability	Connection	Function	Symbol	Flow Rate (NI/min)	Operating Pressures (Bar)	Actuating Force*
358-D15-9A5	✓	1/8	5/2	VM16	700	4-10	2N

*Actuating force at 6 Bar

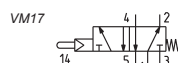

Straight Connection	Elbow Fitting	Silencer
		
S6510 6-1/8	S6520 6-1/8	Z901 1/8

Valve Mod. 458-015-194, 5/2



Part Number	Availability	Connection	Function	Symbol	Flow Rate (NI/min)	Operating Pressures (Bar)	Actuating Force*
458-015-194	✓	1/8	5/2	VM17	650	2.5-8	6N

*Actuating force at 6 Bar

Straight Connection	Elbow Fitting	Silencer
		
S6510 6-1/8	S6520 6-1/8	Z901 1/8

Valve Mod. 458-011-294, 5/2



- ✓ Ex Stock
- 🔧 UK Assembly
- ☎ Please Call Sales Office

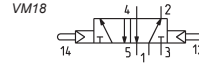

Part Number	Availability	Connection	Function	Symbol	Flow Rate (NI/min)	Operating Pressures (Bar)	Actuating Force*
458-011-294	✓	1/8	5/2	VM18	650	2-8	6N

*Actuating force at 6 Bar

ACCESSORIES

Straight Connection	Elbow Fitting	Silencer
S6510 6-1/8	S6520 6-1/8	2901 1/8

Valve Mod. 454-015-194, 5/2

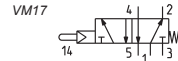

Part Number	Availability	Connection	Function	Symbol	Flow Rate (NI/min)	Operating Pressures (Bar)	Actuating Force*
454-015-194	✓	1/4	5/2	VM17	1250	2.5-8	6N

*Actuating force at 6 Bar

Straight Connection	Elbow Fitting	Silencer
S6510 8-1/4	S6520 8-1/4	2901 1/4-17

Valve Mod. 454-011-294, 5/2

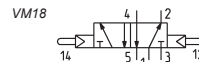

Part Number	Availability	Connection	Function	Symbol	Flow Rate (NI/min)	Operating Pressures (Bar)	Actuating Force*
454-011-294	✓	1/4	5/2	VM18	1250	2-8	6N

*Actuating force at 6 Bar

Straight Connection	Elbow Fitting	Silencer
S6510 8-1/4	S6520 8-1/4	2901 1/4-17

Valve Mod. 458-015-195, 5/2

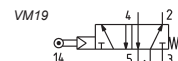

Part Number	Availability	Connection	Function	Symbol	Flow Rate (NI/min)	Operating Pressures (Bar)	Actuating Force*
458-015-195	✓	1/8	5/2	VM19	650	2.5-8	4N

*Actuating force at 6 Bar

Straight Connection	Elbow Fitting	Silencer
S6510 6-1/8	S6520 6-1/8	2901 1/8

Valve Mod. 458-011-295, 5/2



- ✓ Ex Stock
- ✎ UK Assembly
- ☎ Please Call Sales Office

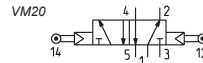

ACCESSORIES

Straight Connection	Elbow Fitting	Silencer
S6510 6-1/8	S6520 6-1/8	2901 1/8

Part Number	Availability	Connection	Function	Symbol	Flow Rate (NI/min)	Operating Pressures (Bar)	Actuating Force*
458-011-295	✓	1/8	5/2	VM20	650	2-8	4N

*Actuating force at 6 Bar

Valve Mod. 454-015-195, 5/2

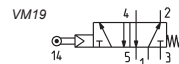

Straight Connection	Elbow Fitting	Silencer
S6510 8-1/4	S6520 8-1/4	2901 1/4-17

Part Number	Availability	Connection	Function	Symbol	Flow Rate (NI/min)	Operating Pressures (Bar)	Actuating Force*
454-015-195	✓	1/4	5/2	VM19	1250	2.5-8	4N

*Actuating force at 6 Bar

Valve Mod. 454-011-295, 5/2

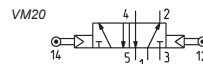

Straight Connection	Elbow Fitting	Silencer
S6510 8-1/4	S6520 8-1/4	2901 1/4-17

Part Number	Availability	Connection	Function	Symbol	Flow Rate (NI/min)	Operating Pressures (Bar)	Actuating Force*
454-011-295	✓	1/4	5/2	VM19	1250	2-8	4N

*Actuating force at 6 Bar

CODING EXAMPLE

3	3	8	-	D15	-	9A5
3	SERIES: 3, 4			D15	D15 = pressure drop/spring 015 = pressure/spring 011 = pressure/pressure	
3	FUNCTION: 3 = 3/2 way N.C. 4 = 3/2 way N.O. 5 = 5/2 way C.A			9A5	RESETTING: 9A5 = lever sensor, spring return 194 = plunger sensor, spring return 294 = plunger sensor, bistable 195 = roller/lever, spring return 295 = roller/lever, bistable	
8	CONNECTIONS: 8 = 1/8 4 = 1/4					

Series 2 and 3 Pneumatic and Electrical - Foot Operated Pedal

1/4, 5/2 way (pneumatic).
with NC/NO contacts (electrical).

VALVES AND SOLENOID VALVES

Pneumatic foot operated pedal Series 3, 5/2



- ✓ Ex Stock
- ✎ UK Assembly
- ☎ Please Call Sales Office

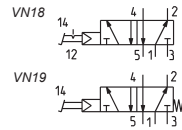

ACCESSORIES

STRAIGHT CONNECTION	ELBOW FITTING	SILENCER
---------------------	---------------	----------



Part Number	Availability	Connection	Function	Symbol	Flow Rate (NI/min)	Operating Pressures (Bar)	Actuating Force*
354N-925	✓	1/4	5/2	VM18-VN19	650	2.5-8	17N

S6510 8-1/4 S6520 8-1/4 2901 1/4-17

*Actuating force at 6 Bar

Electrical foot operated pedal Series 3

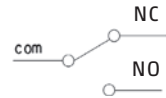

Part Number	Availability	Connection	Function
3E2-925	✓	-	NC/NO contacts

Pneumatic foot operated pedal Series 2, 3/2 NC

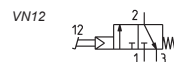
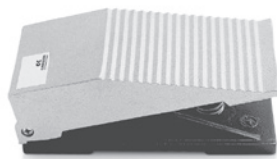

STRAIGHT CONNECTION	ELBOW FITTING
---------------------	---------------



Part Number	Availability	Connection	Function	Symbol	Flow Rate (NI/min)	Operating Pressures (Bar)
235-925	✓	M5	3/2	VN12	60	2-8
234-925	✓	4mm	3/2	VN12	60	2-8

6512 4-M5	6522 4-M5
-	-

Series 2 Manually Operated Console Minivalves

3/2 and 5/3

Connections: M5, Ø4mm cartridge

- ✓ Ex Stock
- ✎ UK Assembly
- ☎ Please Call Sales Office

Push Button



Push Button		
200-895	✓	Ø22

Palm Switch Spring Return



Palm Switch Spring Return		
200-975	✓	Ø22

Palm Switch Twist Unlock



Palm Switch Twist Unlock		
200-972	✓	Ø22

Joystick Spring Return



Joystick Spring Return		
200-905	✓	Ø22

2-Position Selector



2-Position Selector		
200-990	✓	Ø22

3-Position Selector



3-Position Selector		
200-870	✓	Ø22

Key Switch



Key Switch		
200-904	✓	Ø22

Mini Valves 23...-895, 3/2 NC

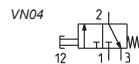

Part Number	Availability	Connection	Function	Symbol	Flow Rate (NI/min)	Operating Pressures (Bar)	Actuating Force*
235-895	✓	M5	3/2 NC	VN04	60	2-8	7N
234-895	✓	4mm	3/2 NC	VN04	60	2-8	7N

*Actuating force at 6 Bar

ACCESSORIES

STRAIGHT CONNECTION	ELBOW FITTING
6512 4-M5	6522 4-M5
-	-

Minivalves Mod. 23...-975, 3/2 NC



- ✓ Ex Stock
- ✎ UK Assembly
- ☎ Please Call Sales Office

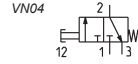

Part Number	Availability	Connection	Function	Symbol	Flow Rate (NI/min)	Operating Pressures (Bar)	Actuating Force*
235-975	✓	M5	3/2 NC	VN04	60	2-8	7N
234-975	✓	4mm	3/2 NC	VN04	60	2-8	7N

*Actuating force at 6 Bar

ACCESSORIES

STRAIGHT CONNECTION	ELBOW FITTING
6512 4-M5	6522 4-M5
-	-

Minivalves Mod. 23...-972, 3/2 NC

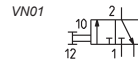

Part Number	Availability	Connection	Function	Symbol	Flow Rate (NI/min)	Operating Pressures (Bar)	Actuating Force*
235-972	✓	M5	3/2 NC	VN01	60	2-8	7N
234-972	✓	4mm	3/2 NC	VN01	60	2-8	7N

*Actuating force at 6 Bar

STRAIGHT CONNECTION	ELBOW FITTING
6512 4-M5	6522 4-M5
-	-

Minivalves Mod. 23...-905, 3/2 NC

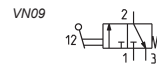

Part Number	Availability	Connection	Function	Symbol	Flow Rate (NI/min)	Operating Pressures (Bar)	Actuating Force*
235-905	✓	M5	3/2 NC	VN09	60	2-8	-
234-905	✓	4mm	3/2 NC	VN09	60	2-8	-

STRAIGHT CONNECTION	ELBOW FITTING
6512 4-M5	6522 4-M5
-	-

Minivalves Mod. 23...-990, 3/2 NC

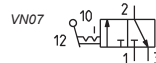

Part Number	Availability	Connection	Function	Symbol	Flow Rate (NI/min)	Operating Pressures (Bar)	Actuating Force*
235-990	✓	M5	3/2 NC	VN07	60	2-8	-
234-990	✓	4mm	3/2 NC	VN07	60	2-8	-

STRAIGHT CONNECTION	ELBOW FITTING
6512 4-M5	6522 4-M5
-	-

Minivalves 28...-870, 5/3 CO



- ✓ Ex Stock
- ✎ UK Assembly
- ☎ Please Call Sales Office

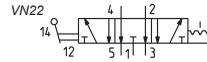

Part Number	Availability	Connection	Function	Symbol	Flow Rate (NI/min)	Operating Pressures (Bar)	Actuating Force*
285-870	✓	M5	5/3 CO	VN22	60	2-8	-
284-870	✓	4mm	5/3 CO	VN22	60	2-8	-

ACCESSORIES

STRAIGHT CONNECTION	ELBOW FITTING
6512 4-M5	6522 4-M5
-	-

Minivalves Mod. 23...-904, 3/2 NC

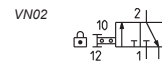

Part Number	Availability	Connection	Function	Symbol	Flow Rate (NI/min)	Operating Pressures (Bar)	Actuating Force*
235-904	✓	M5	3/2 NC	VN22	60	2-8	-
234-904	✓	4mm	3/2 NC	VN22	60	2-8	-

STRAIGHT CONNECTION	ELBOW FITTING
6512 4-M5	6522 4-M5
-	-

Minivalves, 3/2 NC & NO

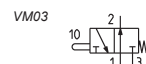
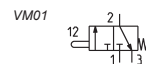

Part Number	Availability	Connection	Function	Symbol	Flow Rate (NI/min)	Operating Pressures (Bar)	Actuating Force*
235-000	✓	M5	3/2 NC	VM01	60	2-8	-
234-000	✓	4mm	3/2 NC	VM01	60	2-8	-
245-000	✓	M5	3/2 NO	VM03	60	2-8	-
244-000	✓	4mm	3/2 NO	VM03	60	2-8	-

STRAIGHT CONNECTION	ELBOW FITTING
6512 4-M5	6522 4-M5
-	-
6512 4-M5	6522 4-M5
-	-

Minivalves 28...-000, 5/3 CO

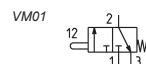

Part Number	Availability	Connection	Function	Symbol	Flow Rate (NI/min)	Operating Pressures (Bar)	Actuating Force*
285-000	✓	M5	5/3 CO	VM01	60	2-8	-
284-000	✓	4mm	5/3 CO	VM01	60	2-8	-

STRAIGHT CONNECTION	ELBOW FITTING
6512 4-M5	6522 4-M5
-	-

Joystick valves Mod. 234-9054, 3/2 NC



- ✓ Ex Stock
- ✎ UK Assembly
- ☎ Please Call Sales Office

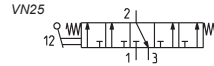

Part Number	Availability	Connection	Function	Symbol	Flow Rate (NI/min)	Operating Pressures (Bar)	Actuating Force*
234-9054	✓	4mm	3/2 NC	VN25	60	2-8	-

End Cover



Bracket		
210-000	✓	Single
220-000	✓	Double

Adapter



Panel Hole Adaptor ø30	
200-2230	✓

CODING EXAMPLE

2	3	4	-	97	5
----------	----------	----------	----------	-----------	----------

2	SERIES: 2	
3	FUNCTION: 3 = 3/2 way NC 4 = 3/2 way NO 8 = 5/3 way CO	97
4	CONNECTIONS: 4 = Ø4mm cartridge 5 = M5	5
		MODE OF OPERATION*: 87 = 3 - position selector 89 = push button 97 = palm-switch 90 = joystick 99 = 2 - position selector 92 = pedal 904 = key 2 positions
		RESETTING: 5 = spring return 0 = stable 2 = latching-twist to release 54 = joy stick

Series 1, 3, 4 and VMS Manually Operated Valves

Series 1, 3 and 4, 3/2, 5/2 and 5/3

Connections: 1/8 - 1/4

VMS Series, 3/2

Connections: 1/8 - 1/4 - 3/8 - 1/2, 3/4

Valve Mod. 338-990, 3/2 NC



- ✓ Ex Stock
- ✎ UK Assembly
- 📞 Please Call Sales Office

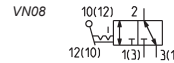

Part Number	Availability	Connection	Function	Symbol	Flow Rate (NI/min)	Operating Pressures (Bar)	Actuating Force*
338-990	✓	1/8	3/2 NC	VN08	700	-0.9-10	18N

*Actuating force at 6 Bar

ACCESSORIES

STRAIGHT CONNECTION	ELBOW FITTING	SILENCER
S6510 6-1/8	S6520 6-1/8	2901 1/8

Valve Mod. 358-990, 5/2

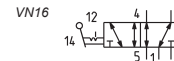

Part Number	Availability	Connection	Function	Symbol	Flow Rate (NI/min)	Operating Pressures (Bar)	Actuating Force*
358-990	✓	1/8	5/2	VN16	700	-0.9-10	18N

*Actuating force at 6 Bar

STRAIGHT CONNECTION	ELBOW FITTING	SILENCER
S6510 6-1/8	S6520 6-1/8	2901 1/8

Valves Mod. 338-89..., 3/2 NC

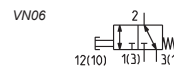

Part Number	Availability	Connection	Function	Symbol	Flow Rate (NI/min)	Operating Pressures (Bar)	Actuating Force*	Colour
338-895	✓	1/8	3/2 NC	VN06	700	-0.9-10	35N	Black
338-896	✓	1/8	3/2 NC	VN06	700	-0.9-10	35N	Green
338-897	✓	1/8	3/2 NC	VN06	700	-0.9-10	35N	Red

*Actuating force at 6 Bar

STRAIGHT CONNECTION	ELBOW FITTING	SILENCER
S6510 6-1/8	S6520 6-1/8	2901 1/8

Valves Mod. 358-89..., 5/2

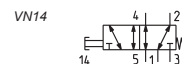

Part Number	Availability	Connection	Function	Symbol	Flow Rate (NI/min)	Operating Pressures (Bar)	Actuating Force*	Colour
358-895	✓	1/8	5/2	VN14	700	-0.9-10	35N	Black
358-896	✓	1/8	5/2	VN14	700	-0.9-10	35N	Green
358-897	✓	1/8	5/2	VN14	700	-0.9-10	35N	Red

*Actuating force at 6 Bar

STRAIGHT CONNECTION	ELBOW FITTING	SILENCER
S6510 6-1/8	S6520 6-1/8	2901 1/8

Valves Mod. 338-97..., 3/2 NC



- ✓ Ex Stock
- ✎ UK Assembly
- ☎ Please Call Sales Office

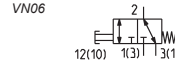

Part Number	Availability	Connection	Function	Symbol	Flow Rate (NI/min)	Operating Pressures (Bar)	Actuating Force*	Colour
338-975	✓	1/8	3/2 NC	VN06	700	-0.9-10	35N	Black
338-976	✓	1/8	3/2 NC	VN06	700	-0.9-10	35N	Green
338-977	✓	1/8	3/2 NC	VN06	700	-0.9-10	35N	Red

*Actuating force at 6 Bar

ACCESSORIES

STRAIGHT CONNECTION	ELBOW FITTING	SILENCER
S6510 6-1/8	S6520 6-1/8	2901 1/8
S6510 6-1/8	S6520 6-1/8	2901 1/8
S6510 6-1/8	S6520 6-1/8	2901 1/8

Valves Mod. 358-97..., 5/2

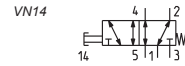

Part Number	Availability	Connection	Function	Symbol	Flow Rate (NI/min)	Operating Pressures (Bar)	Actuating Force*	Colour
358-975	✓	1/8	5/2	VN14	700	-0.9-10	35N	Black
358-976	✓	1/8	5/2	VN14	700	-0.9-10	35N	Green
358-977	✓	1/8	5/2	VN14	700	-0.9-10	35N	Red

*Actuating force at 6 Bar

STRAIGHT CONNECTION	ELBOW FITTING	SILENCER
S6510 6-1/8	S6520 6-1/8	2901 1/8
S6510 6-1/8	S6520 6-1/8	2901 1/8
S6510 6-1/8	S6520 6-1/8	2901 1/8

Valves Mod. 338-91..., 3/2 NC

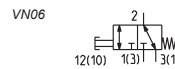
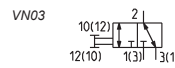

Part Number	Availability	Connection	Function	Symbol	Flow Rate (NI/min)	Operating Pressures (Bar)	Actuating Force*
338-910	✓	1/8	3/2 NC	VN03	700	-0.9-10	6N
338-915	✓	1/8	3/2 NC	VN06	700	-0.9-10	35N

*Actuating force at 6 Bar

STRAIGHT CONNECTION	ELBOW FITTING	SILENCER
S6510 6-1/8	S6520 6-1/8	2901 1/8
S6510 6-1/8	S6520 6-1/8	2901 1/8

Valves Mod. 358-91..., 5/2

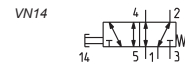
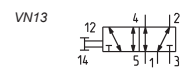

Part Number	Availability	Connection	Function	Symbol	Flow Rate (NI/min)	Operating Pressures (Bar)	Actuating Force*
358-910	✓	1/8	5/2	VN13	700	-0.9-10	6N
358-915	✓	1/8	5/2	VN14	700	-0.9-10	35N

*Actuating force at 6 Bar

STRAIGHT CONNECTION	ELBOW FITTING	SILENCER
S6510 6-1/8	S6520 6-1/8	2901 1/8
S6510 6-1/8	S6520 6-1/8	2901 1/8

Valves Mod. 338-90..., 3/2 NC



- ✓ Ex Stock
- ✍ UK Assembly
- ☎ Please Call Sales Office

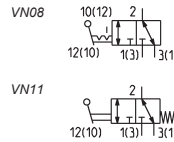

ACCESSORIES

STRAIGHT CONNECTION	ELBOW FITTING	SILENCER
S6510 6-1/8	S6520 6-1/8	2901 1/8
S6510 6-1/8	S6520 6-1/8	2901 1/8

Part Number	Availability	Connection	Function	Symbol	Flow Rate (NI/min)	Operating Pressures (Bar)	Actuating Force*
338-900	✓	1/8	3/2 NC	VN08	700	-0.9-10	6N
338-905	✓	1/8	3/2 NC	VN11	700	-0.9-10	35N

*Actuating force at 6 Bar

Valves Mod. 358-90..., 5/2

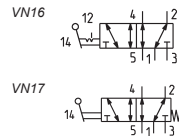

STRAIGHT CONNECTION	ELBOW FITTING	SILENCER
S6510 6-1/8	S6520 6-1/8	2901 1/8
S6510 6-1/8	S6520 6-1/8	2901 1/8

Part Number	Availability	Connection	Function	Symbol	Flow Rate (NI/min)	Operating Pressures (Bar)	Actuating Force*
358-900	✓	1/8	5/2	VN16	700	-0.9-10	5N
358-905	✓	1/8	5/2	VN17	700	-0.9-10	22N

*Actuating force at 6 Bar

Valve Mod. 368-90..., 5/3 CC

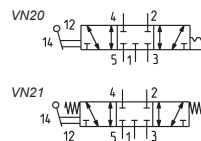

STRAIGHT CONNECTION	ELBOW FITTING	SILENCER
S6510 6-1/8	S6520 6-1/8	2901 1/8
S6510 6-1/8	S6520 6-1/8	2901 1/8

Part Number	Availability	Connection	Function	Symbol	Flow Rate (NI/min)	Operating Pressures (Bar)	Actuating Force*
368-900	✓	1/8	5/3 CC	VN20	500	-0.9-10	5N
368-905	✓	1/8	5/3 CC	VN21	500	-0.9-10	20N

*Actuating force at 6 Bar

Valve Mod. 378-90..., 5/3 CO

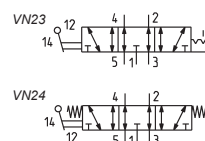

STRAIGHT CONNECTION	ELBOW FITTING	SILENCER
S6510 6-1/8	S6520 6-1/8	2901 1/8
S6510 6-1/8	S6520 6-1/8	2901 1/8

Part Number	Availability	Connection	Function	Symbol	Flow Rate (NI/min)	Operating Pressures (Bar)	Actuating Force*
378-900	✓	1/8	5/3 CO	VN23	500	-0.9-10	5N
378-905	✓	1/8	5/3 CO	VN24	500	-0.9-10	20N

*Actuating force at 6 Bar

See full catalogue or catalogue.camozzi.com for all dimensions.
For technical advice contact our sales office or your local Camozzi distributor.

Valves Mod. 434-91..., 3/2 NC



- ✓ Ex Stock
- ✈ UK Assembly
- 📞 Please Call Sales Office

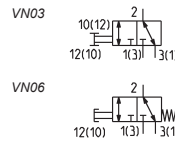

Part Number	Availability	Connection	Function	Symbol	Flow Rate (NI/min)	Operating Pressures (Bar)	Actuating Force*
434-910	✓	1/4	3/2 NC	VN03	1250	-0.9-10	10N
434-915	✓	1/4	3/2 NC	VN06	1250	-0.9-10	37N

*Actuating force at 6 Bar

ACCESSORIES

STRAIGHT CONNECTION	ELBOW FITTING	SILENCER
S6510 8-1/4	S6520 8-1/4	2901 1/4-17
S6510 8-1/4	S6520 8-1/4	2901 1/4-17

Valves Mod. 454-91..., 5/2

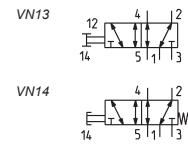

Part Number	Availability	Connection	Function	Symbol	Flow Rate (NI/min)	Operating Pressures (Bar)	Actuating Force*
454-910	✓	1/4	5/2	VN13	1250	-0.9-10	10N
454-915	✓	1/4	5/2	VN14	1250	-0.9-10	37N

*Actuating force at 6 Bar

STRAIGHT CONNECTION	ELBOW FITTING	SILENCER
S6510 8-1/4	S6520 8-1/4	2901 1/4-17
S6510 8-1/4	S6520 8-1/4	2901 1/4-17

Valves Mod. 434-90..., 3/2 NC

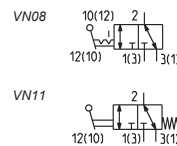

Part Number	Availability	Connection	Function	Symbol	Flow Rate (NI/min)	Operating Pressures (Bar)	Actuating Force*
434-900	✓	1/4	3/2 NC	VN08	1250	-0.9-10	5N
434-905	✓	1/4	3/2 NC	VN11	1250	-0.9-10	37N

*Actuating force at 6 Bar

STRAIGHT CONNECTION	ELBOW FITTING	SILENCER
S6510 8-1/4	S6520 8-1/4	2901 1/4-17
S6510 8-1/4	S6520 8-1/4	2901 1/4-17

Valves Mod. 454-90..., 5/2

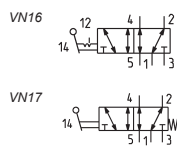

Part Number	Availability	Connection	Function	Symbol	Flow Rate (NI/min)	Operating Pressures (Bar)	Actuating Force*
454-900	✓	1/4	5/2	VN16	1250	-0.9-10	5N
454-905	✓	1/4	5/2	VN17	1250	-0.9-10	37N

*Actuating force at 6 Bar

STRAIGHT CONNECTION	ELBOW FITTING	SILENCER
S6510 8-1/4	S6520 8-1/4	2901 1/4-17
S6510 8-1/4	S6520 8-1/4	2901 1/4-17

Valve Mod. 464-90.., 5/3CC



- ✓ Ex Stock
- ✎ UK Assembly
- ☎ Please Call Sales Office

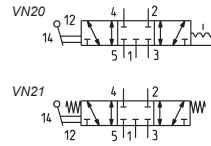

Part Number	Availability	Connection	Function	Symbol	Flow Rate (NI/min)	Operating Pressures (Bar)	Actuating Force*
464-900	✓	1/4	5/3 CC	VN20	1250	-0.9-10	5N
464-905	✓	1/4	5/3 CC	VN21	1250	-0.9-10	10N

*Actuating force at 6 Bar

ACCESSORIES

STRAIGHT CONNECTION	ELBOW FITTING	SILENCER
S6510 8-1/4	S6520 8-1/4	2901 1/4-17
S6510 8-1/4	S6520 8-1/4	2901 1/4-17

Valve Mod. 474-90.., 5/3 CO



Part Number	Availability	Connection	Function	Symbol	Flow Rate (NI/min)	Operating Pressures (Bar)	Actuating Force*
474-900	✓	1/4 CO	5/3	VN23	1250	-0.9-10	5N
474-905	✓	1/4 CO	5/3	VN24	1250	-0.9-10	10N

*Actuating force at 6 Bar

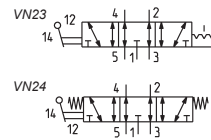

Straight Connection	Elbow Fitting	Silencer
S6510 8-1/4	S6520 8-1/4	2901 1/4-17
S6510 8-1/4	S6520 8-1/4	2901 1/4-17

Valve Mod. 13..-900, 3/2 NC



Part Number	Availability	Connection	Function	Symbol	Flow Rate (NI/min)	Operating Pressures (Bar)	Actuating Force*
138-900	✓	1/8	3/2 NC	VN07	500	0-10	25N
134-900	✓	1/4	3/2 NC	VN07	1250	0-10	30N

*Actuating force at 6 Bar



STRAIGHT CONNECTION	ELBOW FITTING	SILENCER
S6510 6-1/8	S6520 6-1/8	2901 1/8
S6510 8-1/4	S6520 8-1/4	2901 1/4-17

Valve Mod. 15..-900, 5/2



Part Number	Availability	Connection	Function	Symbol	Flow Rate (NI/min)	Operating Pressures (Bar)	Actuating Force*
158-900	✓	1/8	5/2	VN15	500	0-10	45N
154-900	✓	1/4	5/2	VN15	1250	0-10	55N

*Actuating force at 6 Bar



STRAIGHT CONNECTION	ELBOW FITTING	SILENCER
S6510 6-1/8	S6520 6-1/8	2901 1/8
S6510 8-1/4	S6520 8-1/4	2901 1/4-17

Series VMS slide valves



- ✓ Ex Stock
- 🔧 UK Assembly
- ☎ Please Call Sales Office

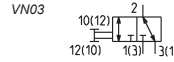

Part Number	Availability	Connection	Function	Symbol	Flow Rate (NI/min) P-A	Flow Rate (NI/min) A-R	Operating Pressures (Bar)
VMS-105-M5	✓	-	-	VN03	140	145	0-8
VMS-118-1/8	✓	-	-	VN03	600	740	0-8
VMS-114-1/4	✓	-	-	VN03	1200	1780	0-8
VMS-138-3/8	✓	-	-	VN03	2100	1830	0-8
VMS-112-1/2	✓	-	-	VN03	3350	4030	0-8
VMS-134-3/4	✓	-	-	VN03	5350	5000	0-8

*Actuating force at 6 Bar

ACCESSORIES

STRAIGHT CONNECTION	ELBOW FITTING
6512 4-M5	6522 4-M5
6512 4-1/8	6522 4-1/8
6512 6-1/4	6522 6-1/4
6512 8-3/8	6522 8-3/8
6512 12-1/2	6522 12-1/2
S6510 16-3/4	S6520 16-3/4

Valve Mod. 13...-935, 3/2 NC

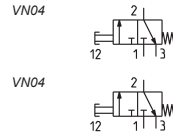

Part Number	Availability	Connection	Function	Symbol	Flow Rate (NI/min)	Operating Pressures (Bar)	Actuating Force*
138-935	✓	1/8	3/2 NC	VN04	500	0-10	38N
134-935	✓	1/4	3/2 NC	VN04	1250	0-10	40N

*Actuating force at 6 Bar

STRAIGHT CONNECTION	ELBOW FITTING	SILENCER
S6510 6-1/8	S6520 6-1/8	2901 1/8
S6510 8-1/4	S6520 8-1/4	2901 1/4-17

CODING EXAMPLE

3	5	8	-	900
3 SERIES: 1, 3, 4		8 CONNECTIONS: 8 = 1/8 4 = 1/4		
	5 FUNCTION: 3 = 3/2 way NC 5 = 5/2 way 6 = 5/3 way C.C. 7 = 5/3 way C.O.			
		900 ACTUATION: 895 = push button, monostable, black 896 = push button, monostable, green 897 = push button, monostable, red 900 = lever, bistable 905 = lever, monostable 910 = knob, bistable 915 = knob, monostable 935 = digital monostable		975 = palm-switch, monostable, black 976 = palm-switch, monostable, green 977 = palm-switch, monostable, red 990 = switch, bistable

Series 2 Mini-Handle Valves

Handle with incorporated micro valve 3/2 NC
Handle with incorporated micro switch

Handle 3/2 NC and NO

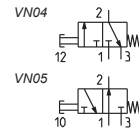
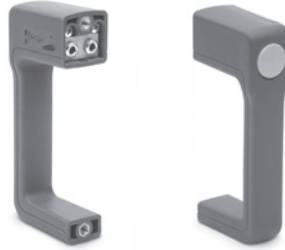

- ✓ Ex Stock
- ✍ UK Assembly
- ☎ Please Call Sales Office

Part Number	Availability	Connection	Function	Symbol	Flow Rate (NI/min)	Operating Pressures (Bar)	Actuating Force*
234-885	✓	-	3/2 NC	VN04	60	2-8	13N (at 6 bar)
244-885	☎	-	3/2 NC	VN05	60	2-8	13N (at 6 bar)

Handle, 3/2 NC

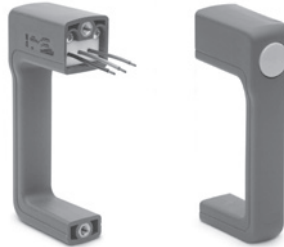

Part Number	Availability	Connection	Function	Symbol	Flow Rate (NI/min)	Operating Pressures (Bar)	Actuating Force*
234-88E	☎	-	3/2 NC	VN04	60	2-8	13N (at 6 bar)

For electrical Characteristics please see full catalogue.

Series 2L Basic Logic Valves

(OR - AND - YES - NOT - MEMORY)
Ø4mm cartridge

Basic logic valves AND / OR

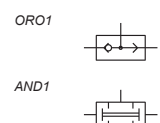

- ✓ Ex Stock
- ✍ UK Assembly
- ☎ Please Call Sales Office

Part Number	Availability	Connection	Function	Symbol	Flow Rate (NI/min) (6 bar ΔP 1bar)	Operating Pressures (Bar)
2LR-SB4-B	✓	-	OR	OR01	70	2-8
2LD-SB4-B	✓	-	AND	AND1	70	2-8

Basic logic valves YES / NOT

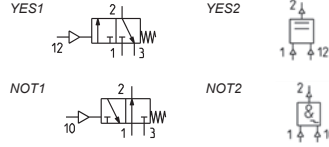

- ✓ Ex Stock
- ✎ UK Assembly
- ☎ Please Call Sales Office

Part Number	Availability	Function	Pneumatic Symbol	Logic Symbol	Flow Rate (NI/min) (6 bar ΔP 1bar)	Operating Pressures (Bar)
2LS-SB4-B	✓	YES	YES1	YES2	70	2-8
2LT-SB4-B	✓	NOT	NOT1	NOT2	70	2-8

Basic logic valves "Memory"



Part Number	Availability	Function	Pneumatic Symbol	Logic Symbol	Flow Rate (NI/min) (6 bar ΔP 1bar)	Operating Pressures (Bar)
2LM-SB4-B	✓	Memory	MEM1	MEM2	70	2-8

Part Number	Availability
2LQ-8A	✓



Series 2L Pneumatically Operated Amplifier Valve

3/2 monostable
Connections: 1/8 - Pilot M5

Pneumatically operated 3/2 NC amplifier valve - 1/8 ports



- ✓ Ex Stock
- ✎ UK Assembly
- ☎ Please Call Sales Office

Part Number	Availability	Connection	Function	Symbol	Flow Rate (NI/min) (6 bar ΔP 1bar)	Operating Pressures (Bar)
2LA-AM	✓	-	3/2 NC	AMP1	120	2-8

Series 2L Sender and Receiver Elements

Sender Series 2L - M5 ports



- ✓ Ex Stock
- ✎ UK Assembly
- ☎ Please Call Sales Office

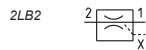

Part Number	Availability	Function	Symbol	Min Pressure (Bar)	Operating Pressures (Bar)
2LB-SR	✓	Receiver	2LB2	0.3	0.6

Receiver sensor Series 2L - M5 ports

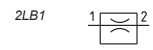

Part Number	Availability	Function	Symbol	Min Pressure (Bar)	Operating Pressures (Bar)
2LB-SE	✓	Sender	2LB1	0.3	2

Series SCS, VNR, VSC, VSO and VMR Automatic Valves

Unidirectional valves VNR

Quick exhaust valves VSC - VSO

Shuttle valve SCS

Connections: M5, 1/8, 1/4, 1/2

Ø4mm cartridge

Circuit selector Mod. SCS

- ✓ Ex Stock
- ✎ UK Assembly
- ☎ Please Call Sales Office

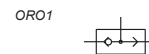

Part Number	Availability	Connection	Function	Symbol	Flow Rate (NI/min)	Operating Pressures (Bar)	Min. Actuation Pressure (Bar)
SCS-668-06	✓	1/8	OR01	OR01	800	0.2-10	0.2

ACCESSORIES

STRAIGHT CONNECTION



S6510 6-1/8

Series VNR Unidirectional Valves (With Tube Connections)

New



- ✓ Ex Stock
- ✎ UK Assembly
- ☎ Please Call Sales Office

VNR1



Part Number	Availability	Symbol	Flow Rate at 6 Bar (NI/min)	Min. Operating Pressure (Bar)	Max. Working Pressure (Bar)
6580 4-VNR	✓	VNR1	85	0.5	10
6580 6-VNR	✓	VNR1	450	0.2	10
6580 8-VNR	✓	VNR1	900	0.2	10

Series VNR unidirectional valves

- ✓ Ex Stock
- 🔧 UK Assembly
- 📞 Please Call Sales Office



VNR1



ACCESSORIES

STRAIGHT CONNECTOR



Part Number	Availability	Connection	Function	Symbol	Flow Rate (NI/min)	Operating Pressures (Bar)	Min. Actuation Pressure (Bar)
VNR-205-M5	✓	M5	-	VNR1	50	1-10	1
VNR-210-1/8	✓	1/8	-	VNR1	600	0.2-10	0.2
VNR-843-07	✓	1/4	-	VNR1	1400	0.2-10	0.2
VNR-238-3/8	✓	3/8	-	VNR1	3000	0.02-10	0.02
VNR-212-1/2	✓	1/2	-	VNR1	5800	0.02-10	0.02
VNR-234-3/4	✓	3/4	-	VNR1	8000	0.06-10	0.06

6512 4-M5
S6510 6-1/8
S6510 8-1/4
S6510 10-3/8
S6510 12-1/2
S6510 16-3/4

Quick exhaust valves Mod. VSO 425-M5



VSC1



Part Number	Availability	Connection	Function	Symbol	Flow Rate (NI/min)	Min Pressure (Bar)	Min. Actuation Pressure (Bar)
Quick Exhaust Valve							
VSO-425-M5	✓	M5	-	VSC1	50	100	1

Quick exhaust valves Mod. VSO 426-04



VSC1



Part Number	Availability	Connection	Function	Symbol	Flow Rate (NI/min)	Min Pressure (Bar)	Min. Actuation Pressure (Bar)
Quick Exhaust Valve							
VSO-426-04	✓	cartridge Ø4	-	VSC1	50	100	1

Series VSC quick exhaust valves



VSC1



STRAIGHT CONNECTOR

SILENCER



Part Number	Availability	Connection	Function	Symbol	Flow Rate (NI/min)	Operating Pressures (Bar)	Min. Actuation Pressure (Bar)
VSC 588-1/8	✓	1/8	-	VSC1	650	1000	0.5
VSC 544-1/4	✓	1/4	-	VSC1	1100	2300	0.3
VSC 522-1/2	✓	1/2	-	VSC1	4500	6700	0.2

S6510 6-1/8	2901 1/8
S6510 8-1/4	2901 1/4
S6510 12-1/2	2901 1/2

Valve with maximum adjustable pressure Mod. VMR 1/8-B10



VMP1



STRAIGHT CONNECTOR



Part Number	Availability	Connection	Function	Symbol	Flow Rate (NI/min)	Operating Pressures (Bar)	Min. Actuation Pressure (Bar)
VMR-1/8-B10	✓	1/8	-	VMP1		1-8	

S6510 6-1/8

Series VBU, VBO Blocking Valves

Unidirectional and bidirectional 1/8, 1/4, 3/8, 1/2
Nominal diameters 5.5 - 8 - 11.

Unidirectional blocking valve

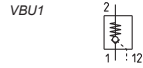

ACCESSORIES

Straight Connection



- ✓ Ex Stock
- ✎ UK Assembly
- ☎ Please Call Sales Office

Part Number	Availability	Connection	Symbol
VBU 1/8	✓	1/8	VBU1
VBU 1/4	✓	1/4	VBU1
VBU 3/8	✓	3/8	VBU1
VBU 1/2	✓	1/2	VBU1

Bidirectional blocking valve

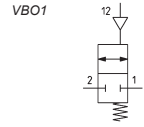

ACCESSORIES

Straight Connection



- ✓ Ex Stock
- ✎ UK Assembly
- ☎ Please Call Sales Office

Part Number	Availability	Connection	Symbol
VBO 1/8	✓	1/8	VBO1
VBO 1/4	✓	1/4	VBO1
VBO 3/8	✓	3/8	VBO1
VBO 1/2	✓	1/2	VBO1

CODING EXAMPLE

VB	U	-	1/8
VB SERIES: VB	U VERSIONS: U = unidirectional O = bidirectional		1/8 CONNECTIONS: 1/8, 1/4, 3/8, 1/2

Unidirectional and Bidirectional Blocking Valves

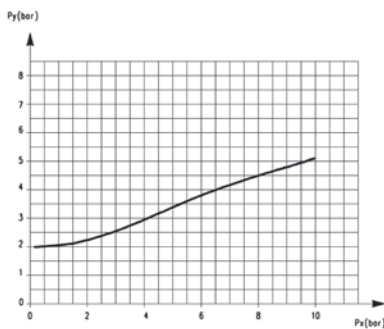

PILOT PRESSURE: This diagram shows the relation between working pressure (Px) and pilot pressure required in order to operate the valve.
The opening pressure of the unidirectional valve is 0,3 bar.

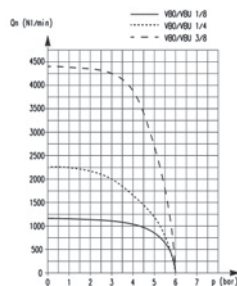

FLOW RATE
Flow Q (NI/min.)
N.B.: Q is determined with an inlet pressure of 6 bar.

Application Schemes

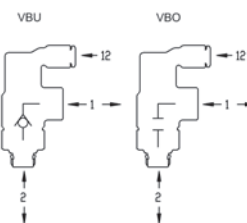
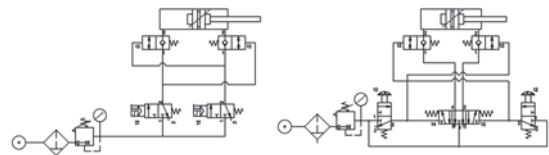
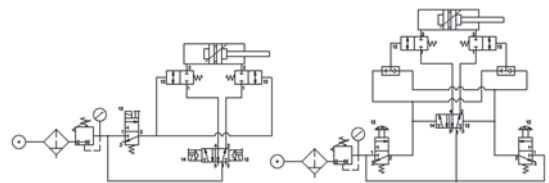

Series SCU, MCU, SVU, MVU, SCO, MCO Flow Control Valves

Unidirectional and bidirectional
banjo flow controllers
Connections: M5, 1/8, 1/4, 3/8, 1/2

VALVES AND SOLENOID VALVES

AVAILABLE BANJO FLOW CONTROLLERS

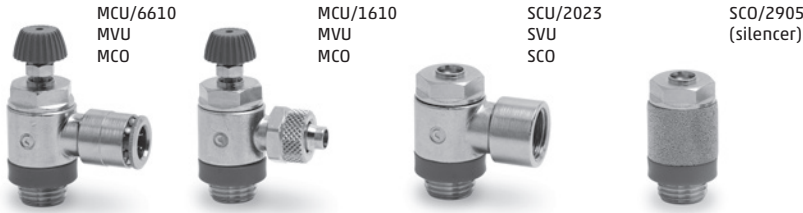

TYPES

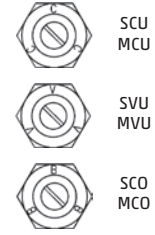

Unidirectional flow controllers Series SCU



- ✓ Ex Stock
- ✦ UK Assembly
- ⊙ Please Call Sales Office

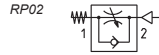

Part Number	Availability
Unidirectional Cylinder Mount	
SCU 602 - M5	✓
SCU 604 - 1/8	✓
SCU 606 - 1/4	✓
SCU 608 - 3/8	✓

Ring connector required see page 166

ACCESSORIES

RING CONNECTOR PUSH IN	RING CONNECTOR PUSH ON	SILENCER
6610 4-M6	-	2905 M5
6610 6-1/8	1610 6/4-1/8	2905 1/8
6610 8-1/4	1610 8/6-1/4	2905 1/4
6610 10-3/8	1610 10/8-3/8	2905 3/8

Unidirectional flow controllers Series MCU

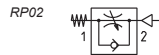

Part Number	Availability
Unidirectional Cylinder Mount	
MCU 702 - M5	✓
MCU 704 - 1/8	✓
MCU 706 - 1/4	✓
MCU 708 - 3/8	✓

Ring connector required see page 166

RING CONNECTOR PUSH IN	RING CONNECTOR PUSH ON	SILENCER
6610 4-M6	-	2905 M5
6610 6-1/8	1610 6/4-1/8	2905 1/8
6610 8-1/4	1610 8/6-1/4	2905 1/4
6610 10-3/8	1610 10/8-3/8	2905 3/8

Unidirectional flow controllers Series SVU

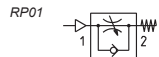

Part Number	Availability
Unidirectional Valve Mount	
SVU 602 - M5	✓
SVU 604 - 1/8	✓
SVU 606 - 1/4	✓

Ring connector required see page 166

RING CONNECTOR PUSH IN	RING CONNECTOR PUSH ON	SILENCER
6610 4-M6	-	2905 M5
6610 6-1/8	1610 6/4-1/8	2905 1/8
6610 8-1/4	1610 8/6-1/4	2905 1/4

Unidirectional flow controllers Series MVU

- ✓ Ex Stock
- 🔧 UK Assembly
- 📞 Please Call Sales Office

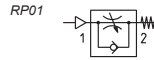

Part Number	Availability
Unidirectional Valve Mount	
MVU 702 - M5	✓
MVU 704 - 1/8	✓
MVU 706 - 1/4	✓

Ring connector required see page 166

ACCESSORIES

RING CONNECTOR PUSH IN	RING CONNECTOR PUSH ON	SILENCER
6610 4-M6	-	2905 M5
6610 6-1/8	1610 6/4-1/8	2905 1/8
6610 8-1/4	1610 8/6-1/4	2905 1/4

Bidirectional flow controllers Series SCO

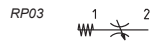

Part Number	Availability
Bidirectional Cylinder Mount	
SCO 602 - M5	✓
SCO 604 - 1/8	✓
SCO 606 - 1/4	✓

Ring connector required see page 166

RING CONNECTOR PUSH IN	RING CONNECTOR PUSH ON	SILENCER
6610 4-M6	-	2905 M5
6610 6-1/8	1610 6/4-1/8	2905 1/8
6610 8-1/4	1610 8/6-1/4	2905 1/4

Bidirectional flow controllers Series MCO

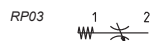

Part Number	Availability
Bidirectional Cylinder Mount	
MCO 702 - M5	✓
MCO 704 - 1/8	✓
MCO 706 - 1/4	✓

Ring connector required see page 166

RING CONNECTOR PUSH IN	RING CONNECTOR PUSH ON	SILENCER
6610 4-M6	-	2905 M5
6610 6-1/8	1610 6/4-1/8	2905 1/8
6610 8-1/4	1610 8/6-1/4	2905 1/4

Unidirectional flow controllers Series SCU



- ✓ Ex Stock
- ✎ UK Assembly
- 📞 Please Call Sales Office

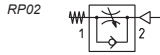

ACCESSORIES

STRAIGHT CONNECTOR



Part Number	Availability
Unidirectional Cylinder Mount	
SCU 610 - 1/2	✓
Pre-assembled with ring connector	

S6510 12-1/2

Unidirectional flow controllers Series MCU

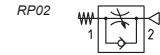

ACCESSORIES

STRAIGHT CONNECTOR



Part Number	Availability
Unidirectional Cylinder Mount	
MCU 710 - 1/2	✓
Pre-assembled with ring connector	

S6510 12-1/2

Unidirectional flow controllers Series SVU

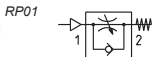

STRAIGHT CONNECTOR



Part Number	Availability
Unidirectional Valve Mount	
SVU 610 - 1/2	✓
Pre-assembled with ring connector	

S6510 12-1/2

Unidirectional flow controllers Series MVU

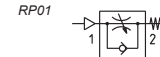

STRAIGHT CONNECTOR



Part Number	Availability
Unidirectional Valve Mount	
MVU 710 - 1/2	✓
Pre-assembled with ring connector	

S6510 12-1/2

Bidirectional flow controllers Series SCO

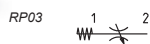

STRAIGHT CONNECTOR



Part Number	Availability
Bidirectional Cylinder Mount	
SCO 610 - 1/2	✓
Pre-assembled with ring connector	

S6510 12-1/2

Bidirectional flow controllers Series MCO



STRAIGHT CONNECTOR



Part Number	Availability
Bidirectional Cylinder Mount	
MCO 710 - 1/2	✓
Pre-assembled with ring connector	

S6510 12-1/2

Series SCU, MCU, SVU, MVU, SCO, MCO Flow Control Valves

- ✓ Ex Stock
- ✎ UK Assembly
- ☎ Please Call Sales Office

Flow Control Valves with Silencer Series RSW

Part Number	Availability
RSW 1/8	✓
RSW 1/4	✓
RSW 3/8	✓
RSW 1/2	✓



Silenced Exhaust Controllers Series SCO + 2905

Part Number	Availability
SCO 602-M5+2905 M5	✓
SCO 604-1/8+2905 1/8	✓
SCO 606-1/4+2905 1/4	✓



CODING EXAMPLE

M	CU	7	02	-	M5
M	ACTUATION: M = Manual S = Screwdriver				
CU	ASSEMBLY: CU = on cylinders unidirectional VU = on valves unidirectional CO = bidirectional		02 NOMINAL DIAMETER: 02 = Ø 1.5 max 04 = Ø 2 max 06 = Ø 4 max 08 = Ø 7 max 10 = Ø 12 max		
7	VERSIONS: 6 = needle (screwdriver operated) 7 = needle (manual operated)		M5 CONNECTIONS: M5, 1/8, 1/4, 3/8, 1/2		

Single Banjo Connector



Single Banjo Connector	Availability
6610 4 - M5	✓
6610 4 - M6•	✓
6610 4 - 1/8	✓
6610 5 - M5	✓
6610 5 - M6•	✓
6610 5 - 1/8	✓
6610 6 - M5	✓
6610 6 - M6•	✓
6610 6 - 1/8	✓
6610 6 - 1/4	✓
6610 8 - 1/8	✓
6610 8 - 1/4	✓
6610 8 - 3/8	✓
6610 10 - 1/4	✓
6610 10 - 3/8	✓
6610 12 - 1/2	✓

Single Banjo Ring Connector



Single Banjo Ring Connector	Availability
1610 5/3 - M5	✓
1610 5/3 - M6•	✓
1610 5/3 - 1/8	✓
1610 6/4 - M5	✓
1610 6/4 - M6•	✓
1610 6/4 - 1/8	✓
1610 6/4 - 1/4	✓
1610 6/4 - 3/8	✓
1610 8/6 - 1/8	✓
1610 8/6 - 1/4	✓
1610 8/6 - 3/8	✓
1610 10/8 - 1/8	✓
1610 10/8 - 1/4	✓
1610 10/8 - 3/8	✓
1610 10/8 - 1/2	✓
1610 12/10 - 3/8	✓
1610 12/10 - 1/2	✓
1610 15/12.5 - 1/2	✓

Banjo Ring Connector



Banjo Ring Connector	Availability
2023 M5 - M5	✓
2023 M5 - M6•	✓
2023 1/8 - 1/8	✓
2023 1/4 - 1/4	✓
2023 3/8 - 3/8	✓

Single Banjo Ring Connector



Single Banjo Ring Connector	Availability
1170 6 - 1/8	✓
1170 6 - 1/4	✓
1170 8 - 1/8	✓

Silencing Bush Series 2905

Part Number	Availability
2905 1/8	✓
2905 1/4	✓
2905 3/8	✓



For use with SCO and MCO flow control valves

• Banjo ring connector required for M5 versions of SCU, MCO, SVU, MVU, SCO and MCO

Flow control valves Series PSCU, PMCU, PSVU, PMVU, PSCO and PMCO

Unidirectional and bidirectional flow control valves
Flow Regulators with banjo in technopolymer
Connections: 1/8, 1/4, 3/8

- ✓ Ex Stock
- ✎ UK Assembly
- ☎ Please Call Sales Office

VALVES AND SOLENOID VALVES

Unidirectional Flow Controllers Series PSCU

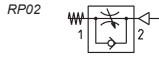

Part Number	Availability
PSCU 602-M5-4	✓
PSCU 602-M5-6	✓
PSCU 604-1/8-4	✓
PSCU 604-1/8-6	✓
PSCU 604-1/8-8	✓
PSCU 606-1/4-6	✓
PSCU 606-1/4-8	✓
PSCU 606-1/4-10	✓
PSCU 608-3/8-10	✓
PSCU 608-3/8-12	✓

Unidirectional Flow Controllers Series PSVU

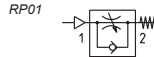

Part Number	Availability
PSVU 602-M5-4	✓
PSVU 602-M5-6	✓
PSVU 604-1/8-4	✓
PSVU 604-1/8-6	✓
PSVU 604-1/8-8	✓
PSVU 606-1/4-6	✓
PSVU 606-1/4-8	✓
PSVU 606-1/4-10	✓
PSVU 608-3/8-10	✓
PSVU 608-3/8-12	✓

Bidirectional Flow controllers Series PSCO



Part Number	Availability
PSCO 602-M5-4	✓
PSCO 602-M5-6	✓
PSCO 604-1/8-4	✓
PSCO 604-1/8-6	✓
PSCO 604-1/8-8	✓
PSCO 606-1/4-6	✓
PSCO 606-1/4-8	✓
PSCO 606-1/4-10	✓
PSCO 608-3/8-10	✓
PSCO 608-3/8-12	✓



Unidirectional Flow Controllers Series PMCU

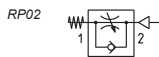

Part Number	Availability
PMCU 702-M5-4	✓
PMCU 702-M5-6	✓
PMCU 704-1/8-4	✓
PMCU 704-1/8-6	✓
PMCU 704-1/8-8	✓
PMCU 706-1/4-6	✓
PMCU 706-1/4-8	✓
PMCU 706-1/4-10	✓
PMCU 708-3/8-10	✓
PMCU 708-3/8-12	✓

Unidirectional Flow Controllers Series PMVU

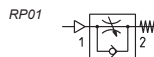

Part Number	Availability
PMVU 702-M5-4	✓
PMVU 702-M5-6	✓
PMVU 704-1/8-4	✓
PMVU 704-1/8-6	✓
PMVU 704-1/8-8	✓
PMVU 706-1/4-6	✓
PMVU 706-1/4-8	✓
PMVU 706-1/4-10	✓
PMVU 708-3/8-10	✓
PMVU 708-3/8-12	✓

Bidirectional Flow Controllers Series PMCO

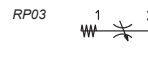

Part Number	Availability
PMCO 702-M5-4	✓
PMCO 702-M5-6	✓
PMCO 704-1/8-4	✓
PMCO 704-1/8-6	✓
PMCO 704-1/8-8	✓
PMCO 706-1/4-6	✓
PMCO 706-1/4-8	✓
PMCO 706-1/4-10	✓
PMCO 708-3/8-10	✓
PMCO 708-3/8-12	✓



TYPES



PSCU
PMCU



PSVU
PMVU



PSCO
PMCO

PSCU-PMCU = assembly directly on the cylinders
PSVU-PMVU = assembly directly on the valves
PSCO-PMCO = assembly directly on the cylinders or valves

CODING EXAMPLE

P	M	CU	7	04	-	1/8	-	4
----------	----------	-----------	----------	-----------	----------	------------	----------	----------

P	SERIES: P		
M	ACTUATION: M = Manual S = Screwdriver	04	NOMINAL DIAMETER: 04 = Ø 2mm max 06 = Ø 4mm max 08 = Ø 4mm max
CU	ASSEMBLY: CU = on cylinders unidirectional VU = on valves unidirectional CO = bidirectional	1/8	CONNECTIONS: 1/8 1/4 3/8
7	VERSIONS: 6 = needle (screwdriver operated) 7 = needle (manual operated)	4	TUBE: 4 = Ø 4mm 6 = Ø 6mm 8 = Ø 8mm 10 = Ø 10mm 12 = Ø 12mm

Series GSCU, GMCU, GSVU, GMVU, GSCO and GMCO Flow Control Valves

Unidirectional and bidirectional M5, 1/8 and 1/4
banjo flow controllers
Nominal diameters 1.5 - 3.5 and 5

Unidirectional Cylinder Mounted

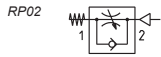

Unidirectional Cylinder Mounted

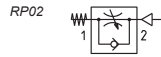

Unidirectional Valve Mounted

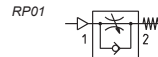

Unidirectional Valve Mounted

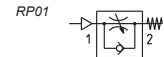

Unidirectional Cylinder Mounted	
GSCU 813-M5-3	✓
GSCU 814-M5-4	✓
GSCU 803-1/8-6	✓
GSCU 804-1/8-8	✓
GSCU 805-1/4-8	✓
GSCU 806-1/4-10	✓
Pre-assembled with ring connector	

Unidirectional Cylinder Mounted	
GMCU 913-M5-3	✓
GMCU 914-M5-4	✓
GMCU 903-1/8-6	✓
GMCU 904-1/8-8	✓
GMCU 905-1/4-8	✓
GMCU 906-1/4-10	✓
Pre-assembled with ring connector	

Unidirectional Valve Mounted	
GSVU 813-M5-3	✓
GSVU 814-M5-4	✓
GSVU 803-1/8-6	✓
GSVU 804-1/8-8	✓
GSVU 805-1/4-8	✓
GSVU 806-1/4-10	✓
Pre-assembled with ring connector	

Unidirectional Valve Mounted	
GMVU 913-M5-3	✓
GMVU 914-M5-4	✓
GMVU 903-1/8-6	✓
GMVU 904-1/8-8	✓
GMVU 905-1/4-8	✓
GMVU 906-1/4-10	✓
Pre-assembled with ring connector	

Bidirectional

Bidirectional	
GSCO 813-M5-3	✓
GSCO 814-M5-4	✓
GSCO 803-1/8-6	✓
GSCO 804-1/8-8	✓
GSCO 805-1/4-8	✓
GSCO 806-1/4-10	✓
Pre-assembled with ring connector	



Bidirectional

Bidirectional	
GMCO 913-M5-3	✓
GMCO 914-M5-4	✓
GMCO 903-1/8-6	✓
GMCO 904-1/8-8	✓
GMCO 905-1/4-8	✓
GMCO 906-1/4-10	✓
Pre-assembled with ring connector	



CODING EXAMPLE

GM	CU	9	03	-	1/8	-	6
GM	ACTUATION: GM = manual GS = screwdriver	9	VERSIONS: 8 = needle (screwdriver operated) 9 = needle (manually operated)		1/8		CONNECTIONS: M5, 1/8, 1/4
CU	ASSEMBLY: CU = on cylinders unidirectional VU = on valves unidirectional CO = bidirectional	03	NOMINAL DIAMETER: size ∅ tube 13 = 1.5 3 14 = 1.5 4 03 = 3.5 6 04 = 3.5 8 05 = 5 8 06 = 5 10		6		∅ TUBE: 3, 4, 6, 8, 10

Series TMCU, TMVU and TMCV Flow Control Valves

Unidirectional and bidirectional 1/8, 1/4, 3/8, 1/2
Banjo flow controllers nominal diameters Ø 2 - 3.8 - 5.8 - 8 mm

VALVES AND SOLENOID VALVES

Series TMCU Valves

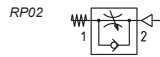

Unidirectional	A	B	Availability
TMCU 972-1/8-4	1/8	4	✓
TMCU 974-1/8-6	1/8	6	✓
TMCU 974-1/4-6	1/4	6	✓
TMCU 976-1/8-8	1/8	8	✓
TMCU 976-1/4-8	1/4	8	✓
TMCU 976-3/8-8	3/8	8	✓
TMCU 978-3/8-10	3/8	10	✓
TMCU 978-1/2-10	1/2	10	✓

Series TMVU Valves

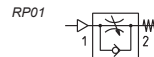

Unidirectional	A	B	Availability
TMVU 972-1/8-4	1/8	4	✓
TMVU 974-1/8-6	1/8	6	✓
TMVU 974-1/4-6	1/4	6	✓
TMVU 976-1/8-8	1/8	8	✓
TMVU 976-1/4-8	1/4	8	✓
TMVU 976-3/8-8	3/8	8	✓
TMVU 978-3/8-10	3/8	10	✓
TMVU 978-1/2-10	1/2	10	✓

Series TMCV Valves

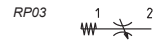

Bidirectional	A	B	Availability
TMCV 972-1/8-4	1/8	4	✓
TMCV 974-1/8-6	1/8	6	✓
TMCV 974-1/4-6	1/4	6	✓
TMCV 976-1/8-8	1/8	8	✓
TMCV 976-1/4-8	1/4	8	✓
TMCV 976-3/8-8	3/8	8	✓
TMCV 978-3/8-10	3/8	10	✓
TMCV 978-1/2-10	1/2	10	✓

CODING EXAMPLE

TM	CU	9	74	-	1/8	-	6
TM	ACTUATION: TM = manual	9	VERSIONS: 9 = needle (manually operated)	1/8	CONNECTIONS: 1/8, 1/4, 3/8, 1/2		
CU	ASSEMBLY: CU = on cylinders unidirectional VU = on valves unidirectional CO = bidirectional	74	NOMINAL DIAMETER: size Ø tube 72 = 2 4 74 = 3.8 6 76 = 5.8 8 78 = 8 10	6	Ø TUBE: 4, 6, 8, 10		

UK Cylinder Service



Reduce Lead Times for Pneumatic Cylinders

- Built the same or next day
- Includes many cylinder types

Series RFU and RFO in Line Flow Control Valves

Panel or wall-mounted flow controllers

Unidirectional RFU and bidirectional RFO Connections: M5, 1/8, 1/4, 3/8 and 1/2

Nominal diameter: M5 = 1.5, 1/8 = 2 and 3mm, 1/4 = 4 and 6mm, 3/8 and 1/2 = 7mm

Unidirectional flow control valves Series RFU



- ✓ Ex Stock
- 🔧 UK Assembly
- 📞 Please Call Sales Office

Part Number	Orifice (mm)	Availability	Connection
Unidirectional			
RFU 452-M5	1.5	✓	M5
RFU 482-1/8	2	✓	1/8
RFU 483-1/8	3	✓	1/8
RFU 444-1/4	4	✓	1/4
RFU 446-1/4	6	✓	1/4
RFU 467-3/8	7	✓	3/8
RFU 477-1/2	7	✓	1/2

STRAIGHT
CONNECTOR



ELBOW
FITTING



6512 4-M5

6522 4-M5

S6510 6-1/8

S6520 6-1/8

S6510 6-1/8

S6520 6-1/8

S6510 8-1/4

S6520 8-1/4

S6510 8-1/4

S6520 8-1/4

S6510 10-3/8

S6520 10-3/8

S6510 12-1/2

S6520 12-1/2

Bidirectional flow control valves Series RFO



Part Number	Availability	Connection
Bidirectional		
RFO 352	✓	M5
RFO 382	✓	1/8
RFO 383	✓	1/8
RFO 344	✓	1/4
RFO 346	✓	1/4
RFO 367	✓	3/8
RFO 377	✓	1/2

STRAIGHT
CONNECTOR



ELBOW
FITTING



6512 4-M5

6522 4-M5

S6510 6-1/8

S6520 6-1/8

S6510 6-1/8

S6520 6-1/8

S6510 8-1/4

S6520 8-1/4

S6510 8-1/4

S6520 8-1/4

S6510 10-3/8

S6520 10-3/8

S6510 12-1/2

S6520 12-1/2

CODING EXAMPLE

RF	U 4	8	2	1/8
RF	SERIES: RF		2	NOMINAL DIAMETER: 4 = Ø4 max (for 1/4 only) 2 = Ø1.5mm max (for M5) 6 = Ø6 max (for 1/4 only) 3 = Ø3 max (for 1/8 only) 7 = Ø7 max (for 3/8, 1/2 only)
U 4	FUNCTION: U4 = unidirectional O3 = bidirectional		1/8	CONNECTIONS: M5, 1/8, 1/4, 3/8, 1/2
8	CONNECTIONS: 4 = 1/4, 5 = M5, 6 = 3/8, 7 = 1/2, 8 = 1/8			

Series 28 Flow Control Valves

Connections: 1/8, 1/4, 3/8, 1/2

VALVES AND SOLENOID VALVES

Valve Mod. 2810



- ✓ Ex Stock
- ✎ UK Assembly
- ☎ Please Call Sales Office

Part Number	Availability	Type
2810 1/8	✓	In Line
2810 1/4	✓	In Line
2810 3/8	✓	In Line
2810 1/2	✓	In Line

Straight Connector



6463 6-1/8
6463 8-1/4
6463 10-1/4
-

Valve Mod. 2820



Part Number	Availability	Type
2820 1/8	✓	In Line
2820 1/4	✓	In Line
2820 3/8	✓	In Line
2820 1/2	✓	In Line

Straight Connector



S6510 6-1/8
S6510 8-1/4
S6510 10-3/8
S6510 12-1/2

Straight Connector



6463 6-1/8
6463 8-1/4
6463 10-1/4
-

Valve Mod. 2830



Part Number	Availability	Type
2830 1/8	✓	In Line
2830 1/4	✓	In Line
2830 3/8	✓	In Line
2830 1/2	✓	In Line

Straight Connector



S6510 6-1/8
S6510 8-1/4
S6510 10-3/8
S6510 12-1/2

Straight Connector



S6520 6-1/8
S6520 8-1/4
S6520 10-3/8
S6520 12-1/2

Valve Mod. 2819



Part Number	Availability	Type
2819 1/8	✓	Panel Mounted
2819 1/4	✓	Panel Mounted

Straight Connector



6463 6-1/8
6463 8-1/4

Valve Mod. 2829

- ✓ Ex Stock
- ✎ UK Assembly
- ⊗ Please Call Sales Office



Part Number	Availability	Type
2829 1/8	✓	Panel Mounted
2829 1/4	✓	Panel Mounted

Straight
Connector



S6510 6-1/8

Straight
Connector



6463 6-1/8

S6510 8-1/4

6463 8-1/4

Valve Mod. 2839



Part Number	Availability	Type
2839 1/8	✓	Panel Mounted
2839 1/4	✓	Panel Mounted
2839 3/8	✓	Panel Mounted
2839 1/2	✓	Panel Mounted

Straight
Connector



S6510 6-1/8

Straight
Connector



S6520 6-1/8

S6510 8-1/4

S6520 8-1/4

S6510 10-3/8

S6520 10-3/8

S6510 12-1/2

S6520 12-1/2

More Than Just Pneumatics

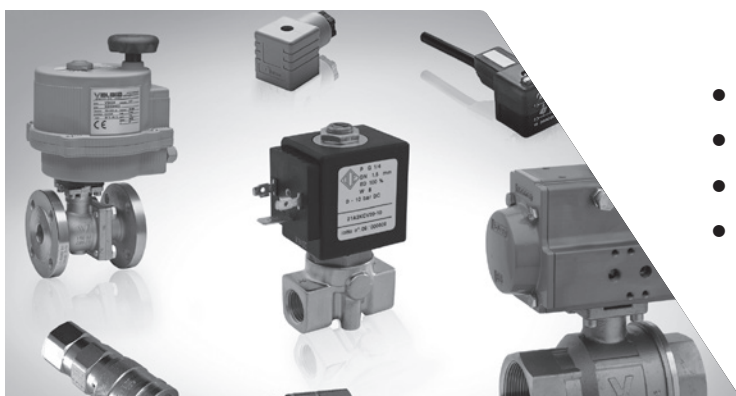

- Process Valves and Actuators
- Hydraulic Components
- Solenoid DIN Connectors
- Industrial Solenoid Valves

Series 2901, 2903, 2921, 2931, 2938, 2939, SP, RSW Adjustable Silencers

Connections: M5, 1/8, 1/4, 3/8, 1/2, 3/4, 1

Silencers Series 2901



- ✓ Ex Stock
- ✎ UK Assembly
- ☎ Please Call Sales Office

Part Number	Availability	Flow Rate NL/min	Noise db (A)
2901 M5	✓	150	66
2901 1/8	✓	700	76
2901 1/4 - 17	✓	1000	78
2901 1/4 - 22	✓	1600	80
2901 3/8	✓	1500	76
2901 1/2	✓	3400	86
2901 3/4	✓	4100	87
2901 1	✓	7600	88

Silencers Series 2903



Part Number	Availability	Flow Rate NL/min	Noise db (A)
2903 1/8	✓	700	74

Silencers Series 2921



Part Number	Availability	Flow Rate NL/min	Noise db (A)
2921 1/8	✓	1550	78
2921 1/4	✓	2400	79
2921 3/8	✓	4800	84
2921 1/2	✓	6800	84
2921 3/4	✓	12700	78
2921 1	✓	>15000	80

Silencers Series 2931



Part Number	Availability	Flow Rate NL/min	Noise db (A)
2931 M5	✓	450	69
2931 M7	✓	1130	76
2931 1/8	✓	1927	88
2931 1/4	✓	3200	86
2931 3/8	✓	4560	81
2931 1/2	✓	6800	87
2931 3/4	✓	12733	78
2931 1	✓	>15000	82

Silencers Series 2938



Part Number	Availability	Flow Rate NL/min	Noise db (A)
2938 M5	✓	546	67
2938 1/8	✓	1441	75
2938 1/4	✓	2752	79
2938 3/8	✓	4735	73
2938 1/2	✓	8534	86

Silencers Series 2939



Part Number	Availability	Flow Rate NL/min	Noise db (A)
2939 4	✓	335	80
2939 6	✓	632	79
2939 8	✓	1229	89
2939 10	✓	2650	87



Part Number	Availability
SP 1/8	✓
SP 1/4	✓
SP 3/8	✓
SP 1/2	✓

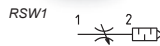



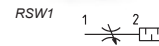

Part Number	Thread	Availability
SCO 604-1/8+2905	1/8	✓
SCO 606-1/4+2905	1/4	✓



Part Number	Availability	Flow Rate NL/min
RSW 1/8	✓	410
RSW 1/4	✓	650
RSW 1/2	✓	1590

Fieldbus and Multipole Systems

1 Valve Islands

	Page
 <p>Series 3 Plug-In Valve Islands, Multipole and Fieldbus</p>	175
 <p>New Series D Valve Islands, Multipole and Fieldbus</p>	176
 <p>Series F Valve islands, Multipole and Fieldbus</p>	183
 <p>Series HN Valve islands, Multipole and Fieldbus</p>	187
 <p>Connectors for Valve Islands</p>	193

Series 3 Plug-In Valve Islands, Multipole and Fieldbus

Plug-In system for Series 3 solenoid valves, G1/8 port.

Valve functions: 2x3/2, 5/2 and 5/3-way CO CC CP.

Multipole with a 25-pin Sub-D connector.

It can interface with all major serial communication protocols.

The Multipole version of Series 3 Plug-In valve island can be easily installed thanks to the front position of the Sub-D connector. The accessories of the new connection system to the Series CX serial nets enable to handle up a multipole valve island by means of a Sub-D connector or through a node integrated in the island. The modularity of the electric and pneumatic parts allows to install up to a maximum of 22 solenoids on 22 valve positions.

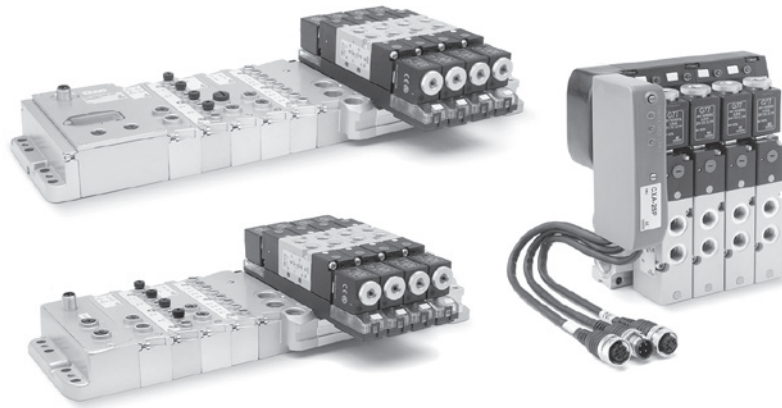

See full technical catalogue for additional information.

GENERAL DATA

PNEUMATIC SECTION

Valve construction	spool type with seals
Valve functions	5/2 - 5/3 CC - 5/3 CO - 5/3 CP - 2x3/2 NO - 2x3/2 NC - 1 3/2 NO + 1 3/2 NC
Materials	AL body, stainless steel spool, NBR seals, technopolymer
Mounting	through-out holes in the manifold
Ports	valve = G1/8 - manifold = G3/8
Installation	in any position
Operating temperature	from 0°C to 60°C (with dry air at -20°C)
Nominal flow rate	Qn 700 NL/min
Nominal diameter	7 mm
Fluid	Filtered air, class 7.4.4 according to ISO 8573-1-2010, without lubrication. If lubricated air is used, it is recommended to use ISO VG32 oil, and to never interrupt the lubrication.

ELECTRICAL SECTION - MULTIPOLE VERSION

Max absorption	3 A
Type of connection	Multipole 25-pin male Sub-D
Supply voltage	24 V DC +/- 10%
Max number of solenoids	22 on 22 valve positions
Signalling	yellow LED
Duty cycle	ED 100%
Protection class	IP65

ELECTRICAL SECTION - FIELDBUS VERSION

General characteristics	see the section about the Series CX multi-serial module (2.3.50)
Max absorption	digital outputs/analogic inputs and outputs 3A digital/analogic inputs 3 A
Voltage tolerances	logic supply 24 V DC +/- 10% power supply 24 V DC +/- 10%

New

Series D Valve Islands, Multipole and Fieldbus

Multipole connection with 25 or 44 pins

Serial connection with the most common communication protocols

Valve function: 2x3/2, 5/2, 5/3 CC CO CP

Thanks to the large range of options available, the Series D valve island represent an excellent solution for different applications, particularly in automation systems.

Small dimensions, high flows, subbases with individual pneumatic and electric modules, an easy subbase connection system, integration of different sizes, constant diagnosis and monitoring of performance parameters make this series a particularly innovative product.

Manual, instruction sheet and configurator are available on the site <http://catalogue.camozzi.com> or by means of the QR code indicated on the product's label.

The Series D valve island is also equipped with CoilVision technology which can monitor and predict the wear and efficiency status of some parts of the solenoid valves. The detected data, alarms and health status can be viewed through different ways either by the blinking of the LEDs positioned on the module transmitted to a PLC or wireless IIoT Gateway and then on to the Cloud.

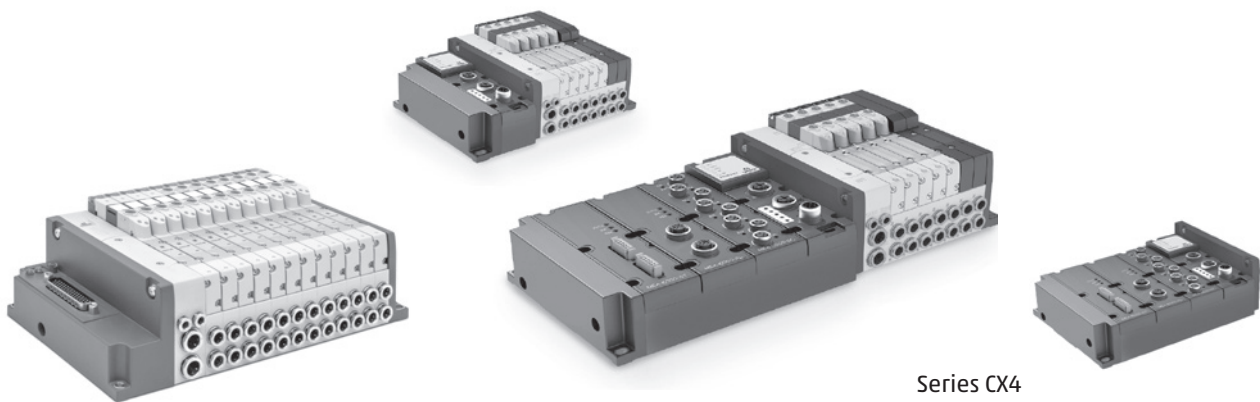

Series CX4
Various Fieldbus Nodes Available
(see full Technical Catalogue)

GENERAL DATA

PNEUMATIC SECTION		
Valve construction	spool with seals	
Valve functions	5/2 monostable and bistable 5/3 CC - CP - CO 2 x 3/2 NC 2 x 3/2 NO 1 x 3/2 NC + 1 x 3/2 NO	
Materials	spool: AL spool seals: HNBR other seals: NBR	body: AL end caps: polymer subbase size 1: polymer
Connections	Series D1: inlet 2 and 4, size 10.5 mm: tube Ø 4, tube Ø 6 supply 1: tube Ø 8 supply 12/14: tube Ø 4 exhaust 3 and 5: tube Ø 8 exhaust 82/84: tube Ø 4	Series D4: inlet 2 and 4, size 25 mm: 3/8 supply 1: 1/2 supply 12/14: 1/8 exhaust 3 and 5: 1/2 or intergraded silencer exhaust 82/84: 1/8
Temperature	0 ÷ 50°C	
Air characteristics	compressed, filtered and non-lubricated air in class 7.4.4 according to ISO 8573-1:2010. In case lubrication should be necessary, only use oils with a maximum viscosity of 32 Cst and the version with external servo-pilot supply. The air quality of the servo-pilot supply must be of class 7.4.4 according to ISO 8573-1:2010 (do not lubricate).	
Valve sizes	Series D1 = 10.5 mm	Series D4 = 25 mm
Operating pressure	-0.9 ÷ 10 bar	
Pilot pressure	2.5 ÷ 7 bar 4.5 ÷ 7 bar (with operating pressure exceeding 6 bar for the version 2x3/2)	
Flow rate	Series D1 = 250 Nl/min (10.5mm)	Series D4 = 2000 Nl/min (25mm)
Mounting position	any position	
Protection class	IP 65	
ELECTRICAL SECTION		
	Multipole Version	Serial Version
Type of Sub-D connector	25 or 44 pins	
Max. absorption	0.8 A (with Sub-D connector 25 pins) 1 A (with Sub-D connector 44 pins)	Digital inputs/outputs and analog inputs/outputs 2.5 A
Supply voltage	24 V DC +/- 10%	
Max. number of coils to operate	22 on 11 valve positions (with Sub-D connector 25 pins) 38 on 19 valve positions (with Sub-D connector 44 pins)	128 on 64 valve positions * Check the number of coils that can be operated simultaneously in the manual
Signalling LED	Multipole: green LED - presence of power red LED - anomaly	

See full catalogue or catalogue.camozzi.com for all dimensions.
For technical advice contact our sales office or your local Camozzi distributor.

VERSIONS: MULTIPOLE AND MULTIPOLE WITH SUB-D ADAPTOR

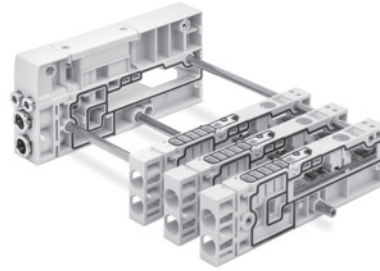

The multipole version can be connected quickly and safely through the connection cable, with angled outlet of 25 or 44 pins, to the electric Sub-D plug integrated in the island. The single modularity of the subbases allows to create islands with up to a maximum of 11 or 19 valve positions depending on the type of connection cable used. The tie rods with different fixed lengths that unite the subbases, can be extended individually through additional tie rods for odd positions. Intermediate subbases with a diaphragm or additional

supply function allow to create diversified pressure and/or exhaust zones, add an incoming air flow and increase the exhaust flow. Furthermore there are subbases available that, besides the aforementioned functions, can interrupt the pneumatic actuation to the coils. This prevents, independently of the electric signal being present or not, to actuate the monostable and bistable valves. The intermediate subbases do not need to be calculated in the number of valve positions.

COILVISION

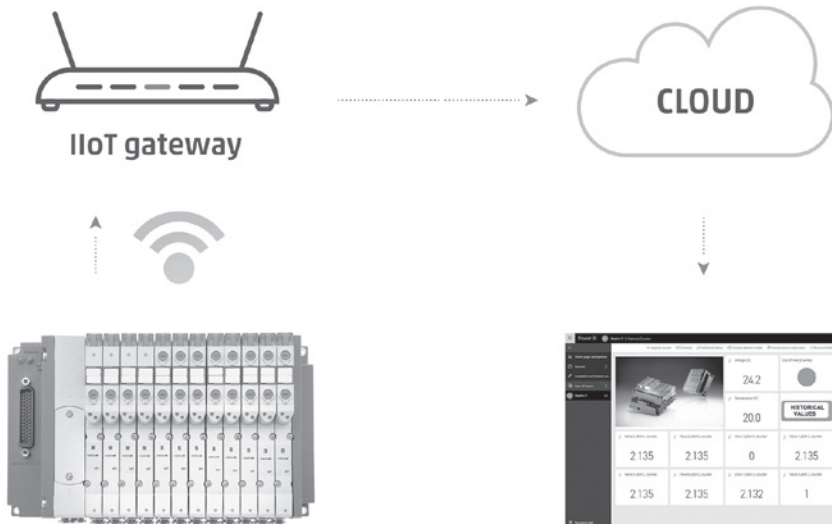

This is a standard function in all our valve islands with Multipole and Serial connection. Its purpose is to monitor the proper function of each solenoid valve individually, particularly the solenoid. The electronics installed in the subbase allows to constantly monitor the efficiency of the driving coil of the solenoid valve. Possible variations with respect to the ideal operating conditions, like for example a higher power consumption, different response times or an increased temperature, are reported by means of a blinking yellow LED of the

interested solenoid. Besides the blinking of this LED, also a general red LED blinks located on the Sub-D module. These indications are combined with an alert message sent to the PLC. By selecting code W from the "Interface" menu, besides the described signals, it is possible to gather all operational data of the islands and send them through WLAN to the corporate net or onto the Cloud to be analysed.

VERSIONS: SERIAL WITH CPU MODULE



The serial module CX4 allows to control the Series D1 valve island with the most common fieldbus protocols. The node enables an inline, daisy chain or star connection. Moreover, different digital and analog I/O modules can be connected to the serial module, as well as modules to acquire data from thermocouples, RTD temperature sensors or bridge configuration sensors.

The mechanical and electrical connection system, and the internal bus allow for extreme flexibility, so you are free to add, move, remove and replace different modules as well as replace its communication protocol. This all in small spaces.

SERIES D1 CODING EXAMPLE - MULTIPOLE VERSION

DM	C	1	M	W	R	A	-	15R	-	4AQH4AX4B	-	3M2L3M2B2C	-	CS	R
-----------	----------	----------	----------	----------	----------	----------	---	------------	---	------------------	---	-------------------	---	-----------	----------

DM	MODULAR ISLAND
C	VALVE C = VC Model
1	SIZE: 1 = 10.5 mm
M	ELECTRICAL CONNECTION: M = Multipole 25 pin PNP Q = Multipole 44 pin PNP
W	INTERFACE: O = without interface W = WLAN
R	MANUAL OVERRIDE: P = push button R = with push and turn device
A	SERVO-PILOT SUPPLY: A = internal B = external
15R	CONNECTOR: 0 = without connector CONNECTOR R WITH CABLE 03R = 3 mt 05R = 5 mt 10R = 10 mt 15R = 15 mt 20R = 20 mt 25R = 25 mt
4AQH4AX4B	SUBBASES: A = cartridge tube Ø4 B = cartridge tube Ø6 SUBBASE:* Q = diaphragm on channels 1, 3, 5 R = diaphragm on channel 1 S = diaphragm on channels 3 and 5 WITH DIAPHRAGM AND EXTERNAL SERVO-PILOT SUPPLY:* QT = diaphragm on channels 1, 3, 5; 12/14 external RT = diaphragm on channel 1; 12/14 external ST = diaphragm on channels 3, 5; 12/14 external WITH DIAPHRAGM AND SILENCER:* QH = diaphragm on channels 1, 3, 5 RH = diaphragm on channel 1 SH = diaphragm on channels 3, 5 SUBBASE FOR ADDITIONAL FLOW :* X = supply (1) and exhausts (3, 5) XH = supply (1) and exhausts (3, 5) with silencer INTERFACE SUBBASE FOR ADDITIONAL FLOW WITH EXTERNAL SERVO-PILOT SUPPLY:* XT = additional supply (1) and exhausts (3, 5) * = These subbases are already provided with cartridges for tube Ø8
3M2L3M2B2C	VALVES: M = 5/2 monostable B = 5/2 bistable C = 2X3/2 NC A = 2 X 3/2 NO G = 2 X 3/2 (NC+NO) V = 5/3 CC K = 5/3 CO N = 5/3 CP L = free position
CS	TERMINALS AND PLATES: fittings on tube connection 1, 3, 5 C = cartridge Ø 8 CS = cartridge Ø 8 3,5 with silencers
R	FIXING TYPE: = direct R = DIN rail

FIELDBUS AND MULTIPOLE SYSTEMS

SERIES D4 CODING EXAMPLE - MULTIPOLE VERSION

DM	C	4	M	W	R	A	-	03R	-	XHCDQ2DXHE	-	ZMB2C	-	E	R
-----------	----------	----------	----------	----------	----------	----------	----------	------------	----------	-------------------	----------	--------------	----------	----------	----------

DM	MODULAR ISLAND
C	VALVE C = VC Model
4	SIZE: 4 = 25 mm
M	ELECTRICAL CONNECTION: M = Multipole 25 pin PNP Q = Multipole 44 pin PNP
W	INTERFACE: O = without interface W = WLAN
R	MANUAL OVERRIDE: P = push button R = with push and turn device
A	SERVO-PILOT SUPPLY: A = internal B = external C = external with fitting for tubing diameter 6 and silencer D = internal with silencer
03R	CONNECTOR: 0 = without connector CONNECTOR R WITH CABLE 03R = 3 mt 05R = 5 mt 10R = 10 mt 15R = 15 mt 20R = 20 mt 25R = 25 mt
XHCDQ2DXHE	SUBBASES / SEALS: K = threaded subbase C = with fittings for tube Ø8 (S6510 8-3/8) D = with fittings for tube Ø10 (S6510 10-3/8) E = with fittings for tube Ø12 (S6510 12-3/8) F = with fittings for tube Ø14 (S6510 14-3/8) SEALS: Q = diaphragm on channels 1, 3, 5 R = diaphragm on channel 1 S = diaphragm on channels 3 and 5 INITIAL SUBBASE/INTERMEDIATE: * X = supply (1) and exhausts (3, 5) XH = supply (1) and exhausts (3, 5) with silencer * These subbases use the connection described in the Terminal Plates menu
ZMB2C	VALVES: M = 5/2 monostable B = 5/2 bistable C = 2 X 3/2 NC A = 2 X 3/2 NO G = 2 X 3/2 (NC+NO) V = 5/3 CC K = 5/3 CO N = 5/3 CP L = free position
E	CONNECTIONS: fittings on tube connections 1, 3, 5 K = threaded 3/8 D = with fittings for tube Ø10 (S6510 10-1/2) E = with fittings for tube Ø12 (S6510 12-1/2) F = with fittings for tube Ø14 (S6510 14-1/2) G = with fittings for tube Ø16 (S6510 16-1/2)
R	FIXING TYPE: = direct R = DIN rail

CODING EXAMPLE - SERIAL VERSION

DM	C	1	01	W	R	A	-	2A2Q	-	2A2BQH4AX4B	-	3M2L3M2B2C	-	CS	R
-----------	----------	----------	-----------	----------	----------	----------	----------	-------------	----------	--------------------	----------	-------------------	----------	-----------	----------

DM	MODULAR ISLAND
C	VALVE C = VC Model
1	SIZE: 1 = 10.5 mm
01	PROTOCOL: 01 = PROFIBUS 05 = Ethercat 03 = CANopen 06 = PROFINET 04 = Ethernet/IP 07 = IO-LINK
W	INTERFACE: O = without interface W = WLAN
R	MANUAL OVERRIDE: P = push button R = with push and turn device
A	SERVO-PILOT SUPPLY: A = internal B = external
2A2Q	INPUT AND OUTPUT MODULES: A = 8 Digital inputs M8 B = 16 Digital inputs, terminal block connection C = 2 Analog inputs (config. 0-10V,±10V,0-20mA,4-20mA,±20mA) M12 D = 2 Analog inputs (config. 0-10V,±10V,0-20mA,4-20mA,±20mA), terminal block E = 2 Inputs, BRIDGE M12 F = 2 Inputs, BRIDGE, TERMINAL BLOCK CONNECTION G = 2 Inputs, RTD M12 (PT100, PT200, PT500, PT1000) H = 2 Inputs, RTD TERMINAL BLOCK CONNECTION (PT100, PT200, PT500, PT1000) L = 2 Inputs, TC M12 (THERMOCOUPLES) M = 2 Inputs, TC TERMINAL BLOCK CONNECTION (THERMOCOUPLES) Q = 8 Digital outputs M8 R = 16 Digital outputs, terminal block connection
2A2BOH4AX4B	SUBBASES: A = cartridge tube Ø4 B = cartridge tube Ø6 SUBBASE* Q = diaphragm on channels 1, 3, 5 R = diaphragm on channel 1 S = diaphragm on channels 3 and 5 WITH DIAPHRAGM AND EXTERNAL SERVO-PILOT SUPPLY* QT = diaphragm on channels 1, 3, 5; 12/14 external RT = diaphragm on channel 1; 12/14 external ST = diaphragm on channels 3, 5; 12/14 external WITH DIAPHRAGM AND SILENCER* QH = diaphragm on channels 1, 3, 5 RH = diaphragm on channel 1 SH = diaphragm on channels 3, 5 SUBBASE FOR ADDITIONAL FLOW X = supply (1) and exhausts (3, 5)* XH = supply (1) and exhausts (3, 5) with silencer INTERFACE SUBBASE FOR ADDITIONAL FLOW WITH EXTERNAL SERVO-PILOT SUPPLY XT = additional supply (1) and exhausts (3, 5) * = These subbases are already provided with cartridges for tube Ø8
3M2L3M2B2C	VALVES: M = 5/2 monostable V = 5/3 CC B = 5/2 bistable K = 5/3 CO C = 2X3/2 NC N = 5/3 CP A = 2 X 3/2 NO L = free position G = 2 X 3/2 (NC+NO)
CS	TERMINALS AND PLATES: fittings on tube connection 1, 3, 5 C = cartridge Ø 8 CS = cartridge Ø 8 3,5 with silencers
R	FIXING TYPE: = direct R = DIN rail

CODING EXAMPLE - INDIVIDUAL VALVES

D	1	E	VC	-	M	P
----------	----------	----------	-----------	----------	----------	----------

D	SERIES
1	SIZE: 1 = 10,5 mm
E	VERSION: E = solenoid valve
VC	COMPONENT: VC = plugin valve
M	TYPE OF SOLENOID VALVE M = 5/2 monostable G = 2 x 3/2 (NC+NO) B = 5/2 bistable V = 5/3 CC C = 2 x 3/2 NC K = 5/3 CO A = 2 x 3/2 NO N = 5/3 CP
P	MANUAL OVERRIDE: P = push button R = with push and turn device

AVAILABLE FUNCTION - SYMBOLS FOR SOLENOID VALVES

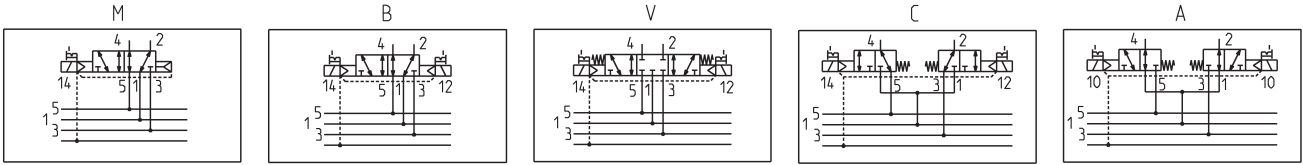

M = 5/2, Monostable

B = 5/2, Bistable

V = 5/3 Centres Closed

C = 2 x 3/2 NC

A = 2 x 3/2 NO

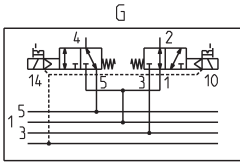

G = 1 x 3/2 NC +
1 x 3/2 NO

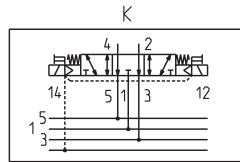

K = 5/3 CO

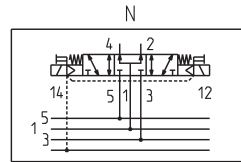

N = 5/3 CP

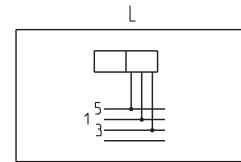

L = free position

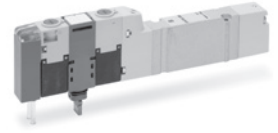

FIELDBUS AND MULTIPOLE SYSTEMS

CODING EXAMPLE - INLET/EXHAUST BASE

D	AM	1	S	-	QH	-	C
----------	-----------	----------	----------	----------	-----------	----------	----------

D	SERIES						
AM	ACCESSORIES AM = modular accessories						
1	SIZE: 1 = 10.5 mm						
S	COMPONENT: S = modular subbase						
QH	INTERMEDIATE DIAPHRAGM SUBBASE Q = diaphragm on channels 1, 3, 5 R = diaphragm on channel 1 S = diaphragm on channels 3, 5			DIAPHRAGM WITH SILENCER QH = diaphragm on channels 1, 3, 5 RH = diaphragm on channel 1 SH = diaphragm on channels 3, 5			
	DIAPHRAGM WITH EXTERNAL SERVO-PILOT SUPPLY QT = diaphragm on channels 1, 3, 5; 12/14 external RT = diaphragm on channels 1; 12/14 external ST = diaphragm on channels 3, 5; 12/14 external			SUBBASE FOR ADDITIONAL FLOW X = supply (1) and exhausts (3,5) XH = supply (1) and exhausts (3,5) with silencer			
				INTERFACE SUBBASE FOR ADDITIONAL FLOW WITH EXTERNAL SERVO-PILOT SUPPLY XT = additional supply (1) and exhausts (3, 5)			
C	VERSION: C = cartridge tube Ø8						

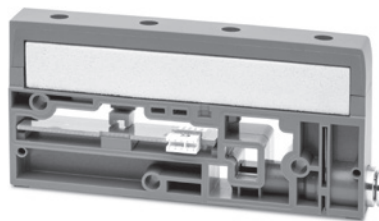

CODING EXAMPLE - SUBBASE

D	AM	1	S	-	A
----------	-----------	----------	----------	----------	----------

D	SERIES				
AM	ACCESSORIES: AM = modular accessories				
1	SIZE: 1 = 10,5 mm				
S	COMPONENT: S = modular subbase				
A	SOLENOID VALVE T = subbase without cartridge A = cartridge tube Ø 4 B = cartridge tube Ø 6				

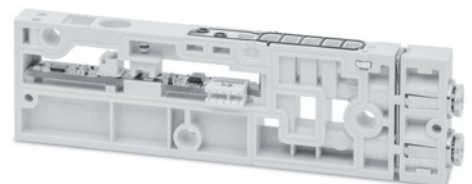

CODING EXAMPLE - TERMINAL PLATES

D	AM	1	0	-	KC
----------	-----------	----------	----------	----------	-----------

D	SERIES
AM	ACCESSORIES AM = modular accessories
1	SIZE 1 = 10,5 mm
0	SERVO-PILOT SUPPLY 0 = internal / external
KC	INITIAL PNEUMATIC TERMINAL PLATE KC = cartridge tube Ø8

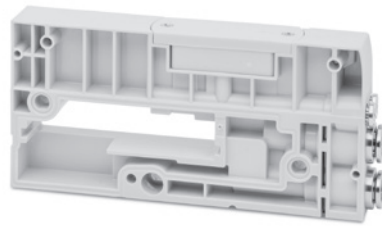

CODING EXAMPLE - END PLATES

D	A	1	T	-	Q	0
----------	----------	----------	----------	----------	----------	----------

D	SERIES
A	ACCESSORIES AM = modular accessories
1	SIZE 1 = 10,5 mm
T	COMPONENT T = electrical terminal plate
Q	TYPE OF TERMINAL PLATE M = multipole 25 pins Q = multipole 44 pins
0	INTERFACE 0 = without interface W = WLAN

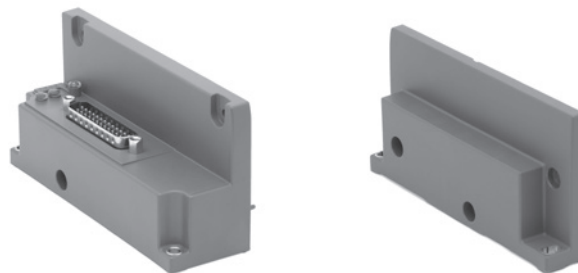

See page 193 for Series D accessories and connections

Series F Valve Islands, Multipole and Fieldbus

Multipole integrated electrical connection (PNP)

Valve functions: 2x2/2, 2x3/2, 5/2, 5/3 CC

It can interface with all major serial communication protocols



FIELDBUS AND MULTIPOLE SYSTEMS

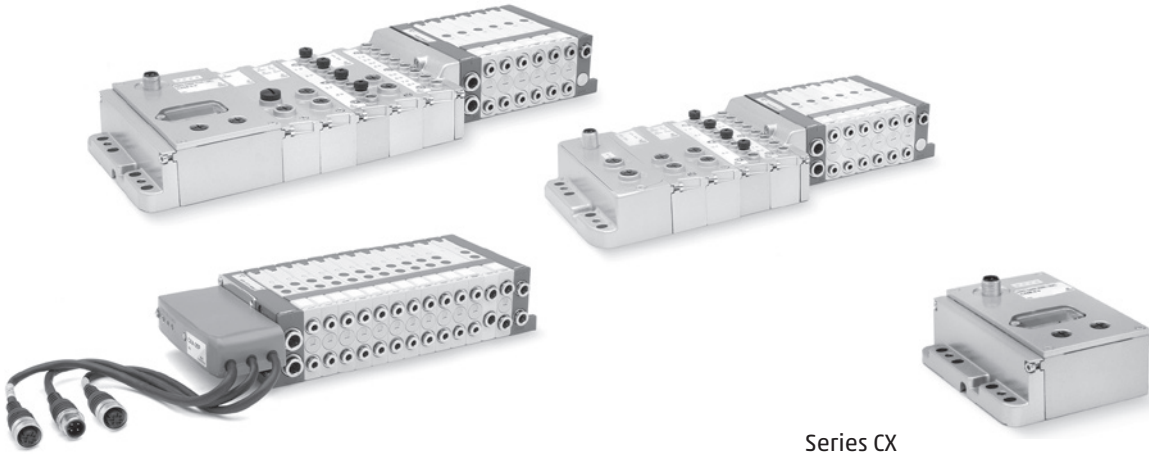

Series CX
Various Fieldbus Nodes Available
(see full Technical Catalogue)

The Multipole version of Series F valve island can be easily integrated with the accessories of the new Series CX multiseriial module, thus connecting to the different serial nets provided. It is also possible to manage a standard multipole island by means of a Sub-D adapter or through an integrated node in the island. The typical Series F single modularity allows the installation of up to 24 solenoids on 24 valve positions, even in the Fieldbus version. The use of technopolymer in this Series has allowed to realize a valve island which is characterized by small dimensions, high flow and reduced weight.

The reduced dimensions, its flexibility during the assembly as well as the wide range of valve functions make Series F a highly innovative product which is suitable for several application requirements. Manuals, instruction sheets and configuration files are available on the site <http://catalogue.camozzi.com> or by means of the QR code indicated on the label of the product.

GENERAL DATA

PNEUMATIC SECTION	
Valve construction	spool with seals
Valve functions	5/2 monostable and bistable - 5/3 CC - 2x2/2 NO2x2/2 NC - 1x2/2 NC + 1x2/2 NO - 2x3/2 NO - 2x3/2 NC - 1x3/2 NC + 1x3/2 NO
Materials	aluminium spool, HNBR seals, other seals in NBR, brass cartridges, technopolymer body and end covers
Connections	Inlets 2 and 4, size 1 (12 mm) = tube Ø4; Ø6 Inlets 2 and 4, size 2 (14 mm) = tube Ø4; Ø6; Ø8 Supply 1, size 1 and 2 = tube Ø8; Ø10 Servo pilot 12/14, size 1 and 2 = tube Ø6 Exhausts 3/5, size 1 and 2 = tube Ø8; Ø10 Exhausts 82/84, size 1 and 2 = tube Ø6
Temperature	0 - 50°C
Air specifications	Filtered compressed air, non lubricated, class 6.4.4 according to ISO 8573-1:2010 standard. If lubrication is necessary, please use only oils with maximum viscosity of 32 Cst and the version with external servo-pilot supply. The servo-pilot supply air quality class must be 6.4.4 according to ISO 8573-1:2010 standard.
Valve sizes	12 mm - 14 mm
Working pressure	- 0.9 - 10 bar
Pilot pressure	3 - 7 bar - 4.5 - 7 bar (with working pressure exceeding 6 bar for the versions 2x2/2 and 2x3/2)
Flow rate	250 NI/min (12 mm) - 500 NI/min (14 mm)
Mounting position	any position
Duty cycle	ED 100%
Protection class (according to EN 60529)	IP40
ELECTRICAL SECTION - MULTIPOLE VERSION	
Supply voltage	24 V DC +/- 10%
Max number of solenoids	24
Max number of valve functions	24 (monostable)
Type of Sub-D connection	Sub-D 25 pin
Max absorption	0.8 A
ELECTRICAL SECTION - FIELDBUS VERSION	
General characteristics	see the section about the Series CX multi-serial module in the full catalogue
Max absorption	digital outputs / analogic outputs and inputs 3 A - digital/analogic inputs 3 A
Supply voltage	logic supply 24 V DC +/- 10% - power supply 24 V DC +/- 10%
Max number of operable coils	24 on 24 valve functions (monostable)

CODING EXAMPLE - MULTIPOLE VERSION

F	P	Z	R	M	T	A	-	MB2CMUL2B	-	ZQR3SLQR
F	SERIES: Series F					MB2CMUL2B SOLENOID VALVES AND ADDITIONAL PLATES *: M = 5/2 monostable D = 5/2 monostable with bistable electric board B = 5/2 bistable C = 2x3/2 NC A = 2x3/2 NO G = 3/2 NC + 3/2 NO E = 2x2/2 NC F = 2x2/2 NO I = 2/2 NC + 2/2 NO V = 5/3 CCL = free position with passing electric board W = free position with bistable electric board Z = free position with monostable electric board X = supplementary supply and exhaust T = separated supply and exhaust U = separated supply, supplementary exhaust K = supplementary supply, separated exhaust				
P	TYPE: P = Pneumatic A = Accessories									
Z	Size: 1 = 12mm 2 = 14mm									
R	MANUAL OVERRIDE: P = Pressure Actuation Control R = Actuation Control with push & turn device									
M	ELECTRICAL CONNECTION: M = Multipole									
T	CARTRIDGES FOR LEFT TERMINAL: S = Tube Ø 8 T = Tube Ø 10 Note: the cartridges for the right terminal are for tube Ø 6.									
A	SERVO-PILOT SUPPLY: A = Internal B = External									
						ZQR3SLQR CARTRIDGES FOR SOLENOID VALVES AND ADDITIONAL PLATES *: Q = tube Ø 4 R = tube Ø 6 S = tube Ø 8 (not for Size 1) L = free position (no cartridges) W = free position with bistable electric board (no cartridges) Z = free position with monostable electric board (no cartridges)				

* In case of identical and consecutive codes, in the choices "SOLENOID VALVES AND ADDITIONAL PLATES" and "CARTRIDGES FOR SOLENOID VALVES AND ADDITIONAL PLATES", replace the letters with the number. With the choice "CARTRIDGES FOR SOLENOID VALVES AND ADDITIONAL PLATES" both of the following connections are defined: 2 and 4; 1 and 3/5. Examples: FP2RMTA-MBCCMULMMBB-QQRSSLRQR R FP2RMTA-MB2CMUL3M2B-ZQR2SL3RQ2R

CODING EXAMPLE - FIELDBUS VERSION

F	P	Z	R	01	T	A	-	ABCR	-	MB2CMUL2B	-	ZQR3SLQR
F	SERIES: Series F					ABCR INPUT / OUTLET MODULES: 0 = no module A = 8 digital inputs M8 B = 4 digital inputs M8 C = 2 analog inputs 4-20 mA D = 2 analog inputs 0-10 V E = 1 analog input 4-20 mA + 1 input 0-10 V Q = 4 M12 duo digital outputs R = 2 analog outputs 4-20 mA T = 2 analog outputs 0-10 V U = 1 analog output 4-20 mA + 1 output 0-10 V V = 1 analog output 4-20 mA + 1 input 0-10 V Z = 1 analog output 4-20 mA + 1 input 4-20 mA K = 1 analog output 0-10 V + 1 input 0-10 V Y = 1 analog output 0-10 V + 1 input 4-20 mA S = Initial subnet module						
P	TYPE: P = Pneumatic A = Accessories											
Z	Size: 1 = 12mm 2 = 14mm											
R	MANUAL OVERRIDE: P = Pressure Actuation Control R = Actuation Control with push & turn device											
01	PROTOCOL: 01 = PROFIBUS-DP 02 = DeviceNet 03 = CANopen 04 = EtherNet/IP 05 = EtherCAT 06 = PROFINET 99 = Expansion Module											
T	CARTRIDGES FOR LEFT TERMINAL: S = Tube Ø 8 T = Tube Ø 10 Note: the cartridges for the right terminal are for tube Ø 6.											
A	SERVO-PILOT SUPPLY: A = Internal B = External											
						MB2CMUL2B SOLENOID VALVES AND ADDITIONAL PLATES: M = 5/2 monostable D = 5/2 monostable with bistable electric board B = 5/2 bistable C = 2x3/2 NC A = 2x3/2 NO G = 3/2 NC + 3/2 NO E = 2x2/2 NC F = 2x2/2 NO I = 2/2 NC + 2/2 NO V = 5/3 CCL = free position with passing electric board W = free position with bistable electric board Z = free position with monostable electric board X = supplementary supply and exhaust T = separated supply and exhaust U = separated supply, supplementary exhaust K = supplementary supply, separated exhaust						
						ZQR3SLQR CARTRIDGES FOR SOLENOID VALVES AND ADDITIONAL PLATES: Q = tube Ø 4 R = tube Ø 6 S = tube Ø 8 (not for Size 1) L = free position (no cartridges) W = free position with bistable electric board (no cartridges) Z = free position with monostable electric board (no cartridges)						

FIELDBUS AND MULTIPOLE SYSTEMS

AVAILABLE FUNCTIONS - SOLENOID VALVES SYMBOLS FOR FP..R - MANUAL OVERRIDE WITH PUSH&TURN DEVICE

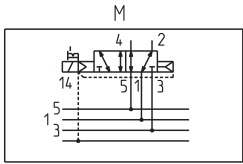

M = 5/2, monostable

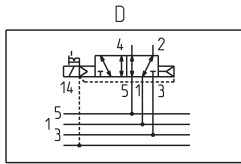

D = 5/2, monostable with bistable board

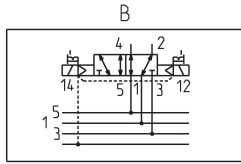

B = 5/2, bistable

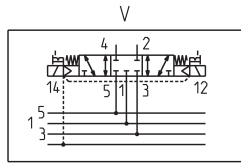

V = 5/3, Centres Closed

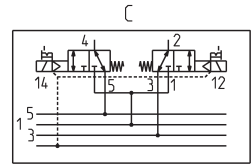

C = 2x3/2 NC

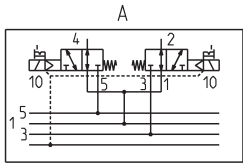

A = 2x3/2 NO

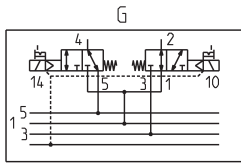

G = 1x3/2 NC + 1x3/2 NO

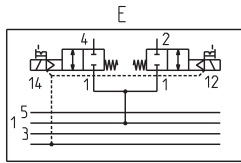

E = 2x2/2 NC

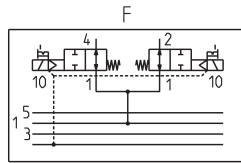

F = 2x2/2 NO

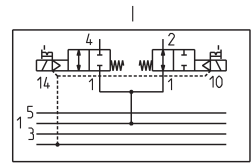

I = 1x2/2 NC + 1x2/2 NO

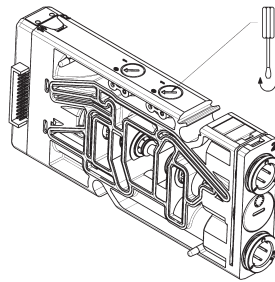

Manual override, version R :
pressure actuation control with PUSH & TURN device.

AVAILABLE FUNCTIONS - SOLENOID VALVES SYMBOLS FOR FP..P - MANUAL OVERRIDE WITHOUT PUSH&TURN DEVICE

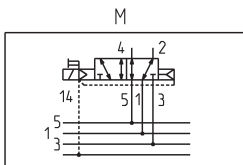

M = 5/2, monostable

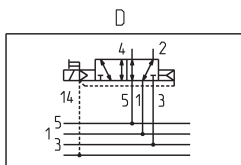

D = 5/2, monostable with bistable board

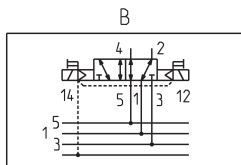

B = 5/2, bistable

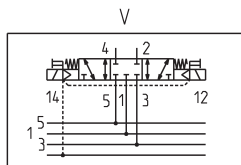

V = 5/3, Centres Closed

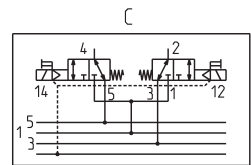

C = 2x3/2 NC

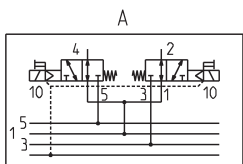

A = 2x3/2 NO

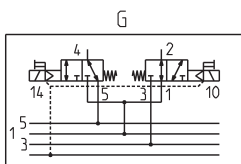

G = 1x3/2 NC + 1x3/2 NO

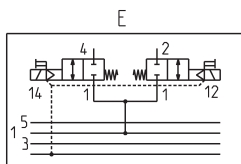

E = 2x2/2 NC

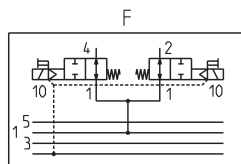

F = 2x2/2 NO

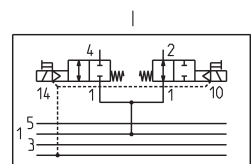

I = 1x2/2 NC + 1x2/2 NO

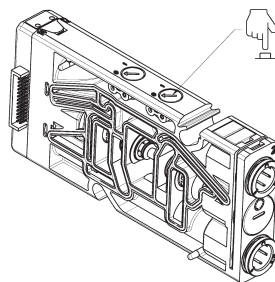

Manual override, version P :
pressure actuation control without PUSH & TURN device (PUSH only).

CODING EXAMPLES OF SINGLE VALVE (SPARE PART) AND TERMINALS (ACCESSORIES)

CODING EXAMPLE OF A SINGLE SOLENOID VALVE		CODING EXAMPLE OF INTERMEDIATE PLATES	
FP2V-MQR		FP2V-WQ	
F	Series	F	Series
P	Type: P = pneumatic	P	Type: P = pneumatic
2	Size: 1 = 12 mm 2 = 14 mm	2	Size: 1 = 12 mm 2 = 14 mm
V	Solenoid valve or additional plate	V	Solenoid valve or additional plate
-		-	
M	Type of function: M = 5/2 monostable D = 5/2 monostable with bistable board B = 5/2 bistable C = 2 x 3/2 NC A = 2 x 3/2 NO G = 3/2 NC + 3/2 NO E = 2 x 2/2 NC F = 2 x 2/2 NO I = 2/2 NC + 2/2 NO V = 5/3 CC	W	Type of function: L = free position W = free position with bistable board Z = free position with monostable board X = supplementary power supply and exhaust T = separated power supply and exhaust U = separated power supply and supplementary exhaust K = supplementary power supply and separated exhaust
Q	Cartridges for solenoid valves: Q = Ø4 R = Ø6 S = Ø8 (not for Size 1)	Q	Cartridges for plates: Q = Ø4 R = Ø6 S = Ø8 (not for Size 1) L = free position (no cartridges) W = free position with bistable board (no cartridges) Z = free position with monostable board (no cartridges)
R	Type of manual override: R = push and turn (bistable) P = pressure (monostable)		
CODING EXAMPLE OF A LEFT TERMINAL		CODING EXAMPLE OF A RIGHT TERMINAL	
FA2T-S		FA2T-AR	
F	Series	F	Series
A	Accessory	A	Accessory
2	Size: 1 = 12 mm 2 = 14 mm	2	Size: 1 = 12 mm 2 = 14 mm
T	Type of accessory: T = terminal	T	Type of accessory: T = terminal
-		-	
S	Cartridges: = no cartridge S = Ø8 T = Ø10	A	Type of servo-pilot: A = internal B = external
		R	Cartridges: R = Ø6

FIELDBUS AND MULTIPOLE SYSTEMS

Series HN Valve Islands, Multipole and Fieldbus

Multipole connection with 25 or 37 pins

Serial connection with the most common communication protocols

Valve functions: 2x2/2; 2x3/2; 5/2; 5/3 CC



FIELDBUS AND MULTIPOLE SYSTEMS

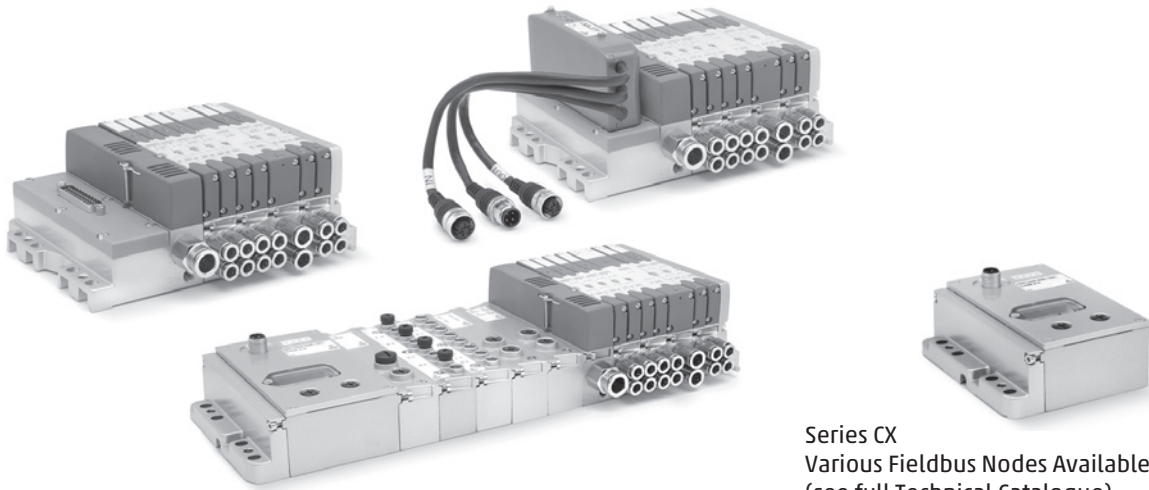

Series CX
Various Fieldbus Nodes Available
(see full Technical Catalogue)

Thanks to the large range of options available, the Series HN valve islands represent an excellent solution for different applications, particularly in automation systems. Small dimensions, high flow, pneumatic and electric modularity, electric connections on boards, possibility to interface with the multi-serial node Series CX, optimization of the signal

distribution thanks to subbases for monostable and bistable solenoid valves are only some of the features that make this series a particularly innovative product. Manuals, instruction sheets and configuration files are available on the site <http://catalogue.camozzi.com> or by means of the QR code indicated on the label of the product.

GENERAL DATA

PNEUMATIC SECTION	
Valve construction	spool type with seals
Valve functions	5/2 monostable and bistable - 5/3 CC - 2 x 2/2 NO - 2 x 2/2 NC - 1 x 2/2 NC+ 1 x NO - 2 x 3/2 NC - 2 x 3/2 NO 1 x 3/2 NC+ 1 x 3/2 NO
Materials	spool in aluminium, spool seals in HNBR, other seals in NBR, cartridges in brass, body and end covers in technopolymer, subbases in aluminium
Connections	Inlets 2 and 4, size 10.5 mm: M7, tube \varnothing 4, tube \varnothing 6, tube \varnothing 8 Inlets 2 and 4, size 21 mm: 1/4, tube \varnothing 10 Supply 1: 1/4, tube \varnothing 8, tube \varnothing 10 Supply 12/14: M7 Exhausts 3 and 5: 1/4 or with integrated silencer Exhausts 82/84: M7
Temperature	0 - 50°C
Air specifications	Filtered compressed air, non lubricated, class 6.4.4 according to ISO 8573-1:2010. If lubrication is necessary, please only use oils with maximum viscosity of 32 Cst and the version with external servo-pilot supply. The servo-pilot supply air quality class must be 6.4.4 according to ISO 8573-1:2010 (do not lubricate).
Valve sizes	10.5mm (2 valves for each subbase) - 21mm (1 valve for each subbase)
Working pressure	- 0.9 - 10 bar
Pilot pressure	3 - 7 bar - 4.5 - 7 bar (with working pressure exceeding 6 bar for the versions 2x2/2 and 2x3/2)
Flow rate	400 NL/min (10.5 mm) - 850 NL/min (21 mm)
Mounting position	any position
Protection class	IP 65
ELECTRICAL SECTION - MULTIPOLE VERSION	
Type of Sub-D connector	25 or 37 pins
Max. absorption	0.8 A (with Sub-D connector 25 pins) - 1 A (with Sub-D connector 37 pins)
Supply voltage	24 V DC +/- 10%
Max. number of coils to operate	24 on 20 valve positions (with Sub-D connector 25 pins) - 32 on 28 valve positions (with Sub-D connector 37 pins)
Valve signalling	yellow led
ELECTRICAL SECTION - FIELDBUS VERSION	
General data	see the section about the Series CX multi-serial module in the full catalogue
Max absorption	digital outputs / analog outputs and inputs 3A - digital/analog inputs 3A
Supply voltage	logic supply 24 V DC +/- 10% - power supply 24 V DC +/- 10%
Max. number of coils to operate	32 on 28 valve positions

CODING EXAMPLE - MULTIPOLE VERSION

HN	5	M	-	03A	-	2Q4AZ2A	-	2B8M4C	-	A
-----------	----------	----------	----------	------------	----------	----------------	----------	---------------	----------	----------

HN	SERIES														
5	SIZE: 1 = 10,5 2 = 21 5 = Mixed														
M	ELECTRICAL CONNECTION: M = Multipole 25 pin PNP N = Multipole 25 pin NPN					H = Multipole 37 pin PNP L = Multipole 37 pin NPN									
03A	CONNECTION: 000 = without connector/cable					CONNECTOR WITH CABLE AXIAL OUTPUT: 03A = 3m 05A = 5m 10A = 10m 15A = 15m 20A = 20m 25A = 25m					CONNECTOR WITHOUT CABLE: 4XA = 25 pins axial 4XR = 25 pins radial 9XA = 37 pins axial 9XR = 37 pins radial				
2Q4AZ2A	SUBBASES FOR 2 SOLENOID VALVES SIZE 1 (*): A (AZ) = M7 threads B (BZ) = 4 fittings for tube Ø4 C (CZ) = 4 fittings for tube Ø6 D (DZ) = channel 1, 3, 5 closed; M7 threads E (EZ) = channel 1, 3, 5 closed; cartridges tube Ø4 F (FZ) = channel 1, 3, 5 closed; cartridges tube Ø6 G (GZ) = channel 3, 5 closed; M7 threads H (HZ) = channel 3, 5 closed; cartridges tube Ø4 I (IZ) = channel 3, 5 closed; cartridges tube Ø6 L (LZ) = channel 1 closed; M7 threads M (MZ) = channel 1 closed; cartridges tube Ø4 N (NZ) = channel 1 closed; cartridges tube Ø6 (*) Subbases with "Z" at the end of their code are used with monostable solenoid valves					FOR SOLENOID VALVES SIZE 2: Q = G 1/8 threads R = cartridges for tube Ø6 S = cartridges for tube Ø8 P = 1/4 threads J = fittings for tube Ø10					SUBBASES FOR PNEUMATIC SUPPLY: X = supplementary supply and exhaust Y = supplementary supply and exhaust with integrated silencer W = supply from the exhausts FOR ELECTRICAL SUPPLY: K = separation of electrical supply SEALS: T = diaphragm on channels 1, 3, 5 U = diaphragm on channel 1 V = diaphragm on channels 3, 5				
2B8M4C	SOLENOID VALVES Size 1 and 2: 0 = island without solenoid valves M = 5/2 Monostable B = 5/2 Bistable V = 5/3 Centres Closed C = 2 x 3/2 NC A = 2 x 3/2 NO G = 1 x 3/2 NC + 1 x 3/2 NO E = 2 x 2/2 NC F = 2 x 2/2 NO I = 1 x 2/2 NC + 1 x 2/2 NO L = free position					SOLENOID VALVE + PRESSURE REGULATOR on channel 1 (size 2 only): N = 5/2 Monostable P = 5/2 Bistable Q = 5/3 Centres Closed R = 2 x 3/2 NC S = 2 x 3/2 NO T = 1 x 3/2 NC + 1 x 3/2 NO U = 2 x 2/2 NC X = 2 x 2/2 NO Y = 1 x 2/2 NC + 1 x 2/2 NO									
A	THREADED TERMINAL PLATES: A = 1, 12/14 in common 3/5, 82/84 threaded ports B = 1, 12/14 separated 3/5, 82/84 threaded ports C = 1, 12/14 in common 3/5, 82/84 with integrated silencer D = 1, 12/14 separated 3/5, 82/84 with integrated silencer					TERMINAL PLATES with FITTINGS FOR TUBE Ø 8 on PORT 1: E = 1, 12/14 in common 3/5, 82/84 conveyable F = 1, 12/14 separated 3/5, 82/84 conveyable G = 1, 12/14 in common 3/5, 82/84 with integrated silencer H = 1, 12/14 separated 3/5, 82/84 with integrated silencer					TERMINAL PLATES with FITTINGS FOR TUBE Ø 10 on PORT 1: I = 1, 12/14 in common 3/5, 82/84 conveyable L = 1, 12/14 separated 3/5, 82/84 conveyable M = 1, 12/14 in common 3/5, 82/84 with integrated silencer N = 1, 12/14 separated 3/5, 82/84 with integrated silencer				

In presence of identical consequent codes both for the subbases as for the valves you need to substitute the letter with the number.
 Ex: HN5M-03A-ABCS-MMCCBBB-A is converted to HN5M-03A-ABCS-2M2C3B-A.

Also available in Series HC Valve
 Island cabinet versions

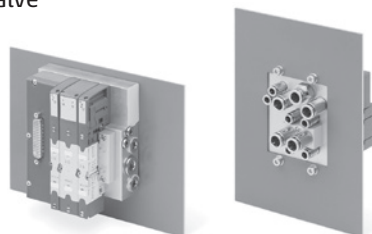

New

CODING EXAMPLE - FIELDBUS VERSION

HN	5	01	-	ABCD	-	2Q4AZ2A	-	2B8M4C	-	A
-----------	----------	-----------	----------	-------------	----------	----------------	----------	---------------	----------	----------

HN	SERIES		
5	SIZE: 1 = 10,5 2 = 21 5 = Mixed		
01	PROTOCOL: 01 = PROFIBUS-DP 02 = DeviceNet 03 = CANopen 04 = EtherNet/IP 05 = EtherCAT 06 = PROFINET 99 = Expansion module		
ABCD	INPUT / OUTPUT MODULES: 0 = no module	INPUT / OUTPUT MODULES: A = 8 Digital Inputs M8 B = 4 Digital Inputs M8 C = 2 Analog Inputs 4-20mA D = 2 Analog Inputs 0-10V E = 1 Analog Input 4-20mA + 1 Input 0-10V Q = 4 Digital Outputs M12 duo R = 2 Analog Outputs 4-20mA T = 2 Analog Outputs 0-10V U = 1 Analog Output 4-20mA + 1 Output 0-10V V = 1 Analog Output 4-20mA + 1 Input 0-10V Z = 1 Analog Output 4-20mA + 1 Input 4-20mA K = 1 Analog Output 0-10V + 1 Input 0-10V Y = 1 Analog Output 0-10V + 1 Input 4-20mA	INPUT / OUTPUT MODULES: S = Initial subnet module
2Q4AZ2A	SUBBASES FOR 2 SOLENOID VALVES SIZE 1 (*): A (AZ) = M7 threads B (BZ) = 4 fittings for tube Ø4 C (CZ) = 4 fittings for tube Ø6 D (DZ) = channel 1, 3, 5 closed; M7 threads E (EZ) = channel 1, 3, 5 closed; cartridges tube Ø4 F (FZ) = channel 1, 3, 5 closed; cartridges tube Ø6 G (GZ) = channel 3, 5 closed; M7 threads H (HZ) = channel 3, 5 closed; cartridges tube Ø4 I (IZ) = channel 3, 5 closed; cartridges tube Ø6 L (LZ) = channel 1 closed; M7 threads M (MZ) = channel 1 closed; cartridges tube Ø4 N (NZ) = channel 1 closed; cartridges tube Ø6 (*): Subbases with "Z" at the end of their code are used with monostable solenoid valves	FOR SOLENOID VALVES SIZE 2: Q = G 1/8 threads R = cartridges for tube Ø6 S = cartridges for tube Ø8 P = 1/4 threads J = fittings for tube Ø10	SUBBASES FOR PNEUMATIC SUPPLY: X = supplementary supply and exhaust Y = supplementary supply and exhaust with integrated silencer W = supply from the exhausts FOR ELECTRICAL SUPPLY: K = separation of electrical supply SEALS: T = diaphragm on channels 1, 3, 5 U = diaphragm seal on channel 1 V = diaphragm seal on channels 3, 5
2B8M4C	SOLENOID VALVES Size 1 and 2: 0 = island without solenoid valves M = 5/2 Monostable B = 5/2 Bistable V = 5/3 Centres Closed C = 2 x 3/2 NC A = 2 x 3/2 NO G = 1 x 3/2 NC + 1 x 3/2 NO E = 2 x 2/2 NC F = 2 x 2/2 NO I = 1 x 2/2 NC + 1 x 2/2 NO L = free position	SOLENOID VALVE + PRESSURE REGULATOR on channel 1 (size 2 only): N = 5/2 Monostable P = 5/2 Bistable Q = 5/3 Centres Closed R = 2 x 3/2 NC S = 2 x 3/2 NO T = 1 x 3/2 NC + 1 x 3/2 NO U = 2 x 2/2 NC X = 2 x 2/2 NO Y = 1 x 2/2 NC + 1 x 2/2 NO	
A	THREADED TERMINAL PLATES: A = 1, 12/14 in common 3/5, 82/84 threaded ports B = 1, 12/14 separated 3/5, 82/84 threaded ports C = 1, 12/14 in common 3/5, 82/84 with integrated silencer D = 1, 12/14 separated 3/5, 82/84 with integrated silencer	TERMINAL PLATES with CARTRIDGES Ø 8: E = 1, 12/14 in common 3/5, 82/84 conveyable F = 1, 12/14 separated 3/5, 82/84 conveyable G = 1, 12/14 in common 3/5, 82/84 with integrated silencer H = 1, 12/14 separated 3/5, 82/84 with integrated silencer	TERMINAL PLATES with CARTRIDGES Ø 10: I = 1, 12/14 in common 3/5, 82/84 conveyable L = 1, 12/14 separated 3/5, 82/84 conveyable M = 1, 12/14 in common 3/5, 82/84 with integrated silencer N = 1, 12/14 separated 3/5, 82/84 with integrated silencer

X, Y and K sub-bases will be equipped with threads or cartridges of the same size of port 1, see the choice "Type of terminal plates". In presence of identical consequent codes both for sub-bases and for valves, you need to substitute the letter with the number.
 Ex: HN501-ABCD-ABCS-MMCCBBB-A is converted to HN501-ABCD-ABCS-2M2C3B-A.

AVAILABLE FUNCTION - SYMBOLS FOR SOLENOID VALVES

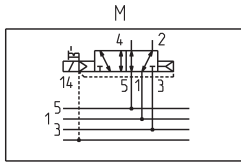

M = 5/2-way, Monostable

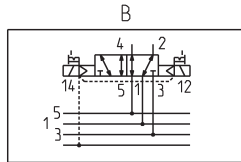

B = 5/2-way, Bistable

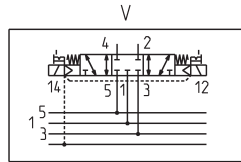

V = 5/3-way Centres Closed

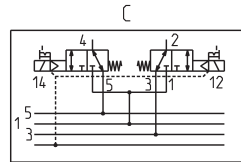

C = 2 x 3/2-way NC

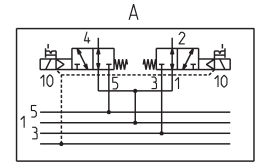

A = 2 x 3/2-way NO

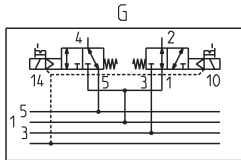

G = 1 x 3/2-way NC + 1 x 3/2-way NO

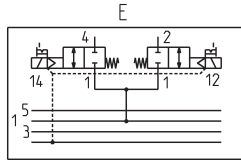

E = 2 x 2/2-way NC

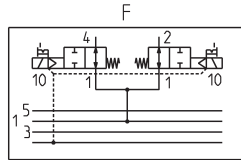

F = 2 x 2/2-way NO

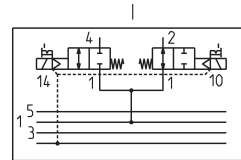

I = 1 x 2/2-way NC + 1 x 2/2-way NO

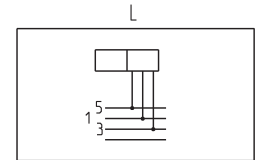

L = free position

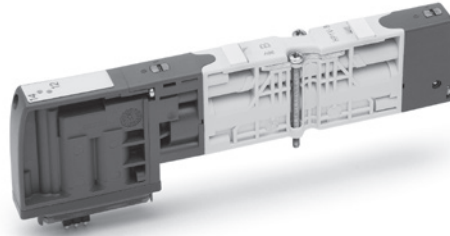

AVAILABLE FUNCTIONS - SYMBOLS FOR SOLENOID VALVES WITH PRESSURE REGULATOR

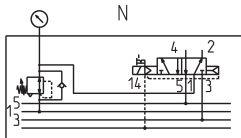

N = 5/2-way, Monostable

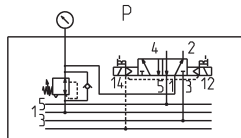

P = 5/2-way, Bistable

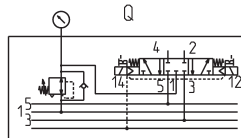

Q = 5/3-way Centres Closed

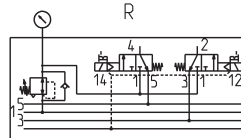

R = 2 x 3/2-way NC

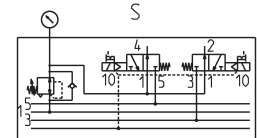

S = 2 x 3/2-way NO

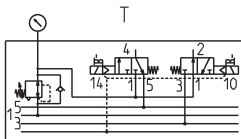

T = 1 x 3/2-way NC + 1 x 3/2-way NO

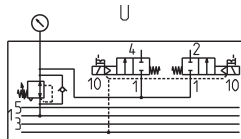

U = 2 x 2/2-way NC

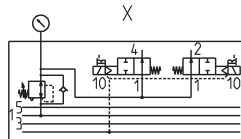

X = 2 x 2/2-way NO

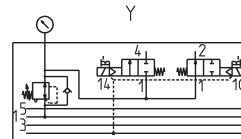

Y = 1 x 2/2-way NC + 1 x 2/2-way NO

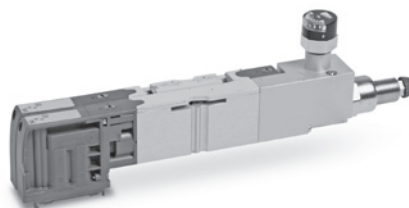

It can be assembled on subbase size 21 only.

AVAILABLE FUNCTIONS - SUBBASE TYPES



Through-subbase s. 10.5
A=M7, B=Ø4, C=Ø6 [*]



Diaphragm lines 1, 3 5
D=M7, E=Ø4, F=Ø6 [*]



Diaphragm line 1
L=M7, M=Ø4, N=Ø6 [*]



Diaphragm lines 3, 5
G=M7, H=Ø4, I=Ø6 [*]



Through-subbase s. 21
Q = 1/8, R = Ø6, S = Ø8



X = supplementary supply and exhaust



K = interm. plate to sep. elec. and suppl. supply



Y = suppl. supply + exhaust with silencer



Z = electro-pneum. interface for HP...F/G/R

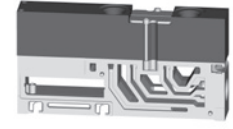

W = plate for supply from exhausts



U = Diaphragm seal - Line 1



V = Diaphragm seal - Lines 3, 5



P = Through seal



T = Diaphragm seal - Lines 1, 3, 5

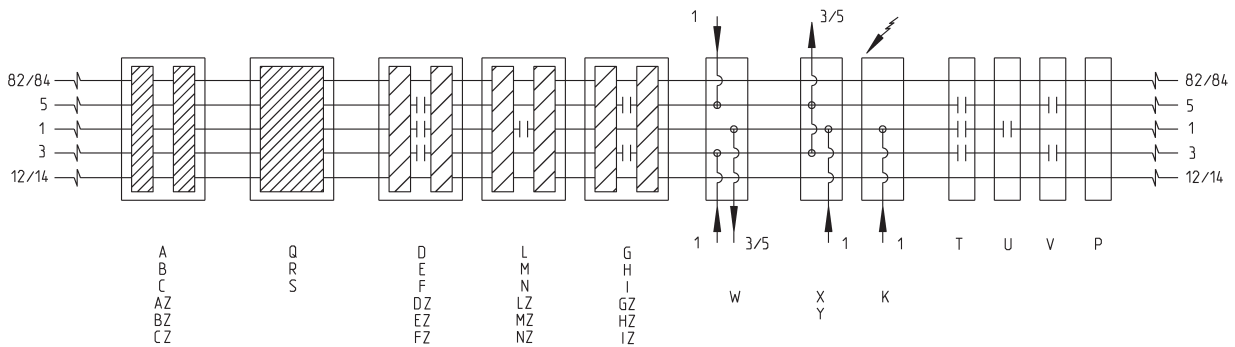

[*] The subbases A, B, C, D, E, F, G, H, I, L, M, N are available also with a board to be used with monostable solenoid valves. To order this version it is necessary to add Z at the end of the code of the standard subbase. Example: AZ instead of A. For further details we suggest you to see the coding example.

CODING EXAMPLE OF MULTIPOLE AND FIELDBUS INTERFACES - ACCESSORIES

HN	A	0	M	-	A
-----------	----------	----------	----------	----------	----------

HN	SERIES				
A	TYPE: A = Accessory				
0	SIZE: 0 = not defined				
M	ELECTRICAL CONNECTION: M = 25 pin PNP Multipole N = 25 pin NPN Multipole H = 37 pin PNP Multipole		L = 37 pin NPN Multipole I = HN interface with Series CX		
A	TERMINALS: A = 1, 12/14 in common - 3/5, 82/84 with thread B = 1, 12/14 separated - 3/5, 82/84 with thread		C = 1, 12/14 in common - 3/5, 82/84 with silencer D = 1, 12/14 separated - 3/5, 82/84 with silencer		
NOTE: The Right Terminal is supplied with seals and fixing screws and available as accessory with the commercial code HA0T-H					

Detailed descriptions of the available accessories can be found in the valve island catalogue

CODING EXAMPLE OF SINGLE VALVE (SPARE PART)

H	P	1	V	-	M
----------	----------	----------	----------	----------	----------

H	SERIES				
P	TYPE: P = pneumatic				
1	SIZE: 1 = 10.5 2 = 21				
V	TYPE OF ACCESSORY: V = Solenoid valve				
M	SOLENOID VALVE: M = 5/2 Monostable B = 5/2 Bistable V = 5/3 Centres Closed C = 2 x 3/2 NC A = 2 x 3/2 NO G = 1 x 3/2 NC + 1 x 3/2 NO E = 2 x 2/2 NC F = 2 x 2/2 NO I = 1 x 2/2 NC + 1 x 2/2 NO L = free position		SOLENOID VALVE + REGULATOR + SUBBASE N = 5/2 Monostable P = 5/2 Bistable Q = 5/3 Centres Closed R = 2 x 3/2 NC S = 2 x 3/2 NO T = 1 x 3/2 NC + 1 x 3/2 NO U = 2 x 2/2 NC X = 2 x 2/2 NO Y = 1 x 2/2 NC + 1 x 2/2 NO		

Detailed descriptions of the available accessories can be found in the valve island catalogue

CODING EXAMPLE OF SUBBASES - ACCESSORIES

H	A	1	R	-	A
----------	----------	----------	----------	----------	----------

H	SERIES				
A	TYPE: A = accessories				
1	SIZE: 0 = for X-Y-K-T-U-V-Z 1 = 10.5		2 = 21		
R	TYPE OF ACCESSORY: R = subbase for multipole connection G = seal		W = subbase without electronic board (option valid only for position 2a) See the components list in the valve island catalogue		
A	SUBBASE: A = through - M7 threads AZ = through - M7 threads, monostable D = channel 1, 3, 5 closed - M7 threads DZ = channel 1, 3, 5 closed - M7 threads, monostable G = channel 3, 5 closed - M7 threads GZ = channel 3, 5 closed - M7 threads, monostable Q = through - G1/8 threads X = supplementary supply and exhaust Y = supplementary supply and exhaust with integrated silencer W = supply from the exhausts K = separation of electrical supply and supplementary pneumatic supply		SEAL: T = diaphragm seal for the closure of channels 1, 3, 5 U = diaphragm seal for the closure of channel 1 V = diaphragm seal for the closure of channels 3, 5 P = through		

NOTE: subbases are always supplied without connection fittings

Detailed descriptions of the available accessories can be found in the components list on the valve island catalogue

Connectors for Valve Islands

For full range please see full catalogue or visit catalogue.camozzi.com

Straight Sub-D 25 pin female connector with axial cable for Series 3 Plug-In and Series F



Part Number	PIN	Cable Length (m)
G3X-3	16	3
G3X-5	16	5
G3X-10	16	10
G3X-15	16	15
G3X-20	16	20
G3X-25	16	25
G4X-3	25	3
G4X-5	25	5
G4X-10	25	10
G4X-15	25	15
G4X-20	25	20
G4X-25	25	25

Right Angular Sub-D 25 pin female connector with axial cable for Series 3 Plug-In and Series F



Part Number	PIN	Cable Length (m)
G3X1-3	16	3
G3X1-5	16	5
G3X1-10	16	10
G3X1-15	16	15
G3X1-20	16	20
G3X1-25	16	25
G4X1-3	25	3
G4X1-5	25	5
G4X1-10	25	10
G4X1-15	25	15
G4X1-20	25	20
G4X1-25	25	25

Mounting brackets for DIN rail Series 3 Fieldbus, D, F, H and CX2
The following is supplied:
2x plates,
2x screws



Part Number
PCF-E520

Right Angular Sub-D female connector 25-44 pins for Series D



Part Number	PIN	Cable Length (m)
G25X1-3	25	3
G25X1-5	25	5
G3X1-10	25	10
G25X1-15	25	15
G25X1-20	25	20
G25X1-25	25	25
G44X1-3	44	3
G44X1-5	44	5
G44X1-10	44	10
G44X1-15	44	15
G44X1-20	44	20
G44X1-25	44	25

Identification Plates for series D.
The packaging contains 45 identification plates 9x5mm



Part Number
HP1/E

Straight Sub-D37 pin female connector with axial cable for Series HN



Part Number	PIN	Cable Length (m)
G9X-3	37	3
G9X-5	37	5
G9X-10	37	10
G9X-15	37	15
G9X-20	37	20
G9X-25	37	25

Right Angular Sub-D 37 pin female connector with radial cable for Series HN



Part Number	PIN	Cable Length (m)
G9X1-3	37	3
G9X1-5	37	5
G9X1-10	37	10
G9X1-15	37	15
G9X1-20	37	20
G9X1-25	37	25

UK Assembled Multipole Valve Islands

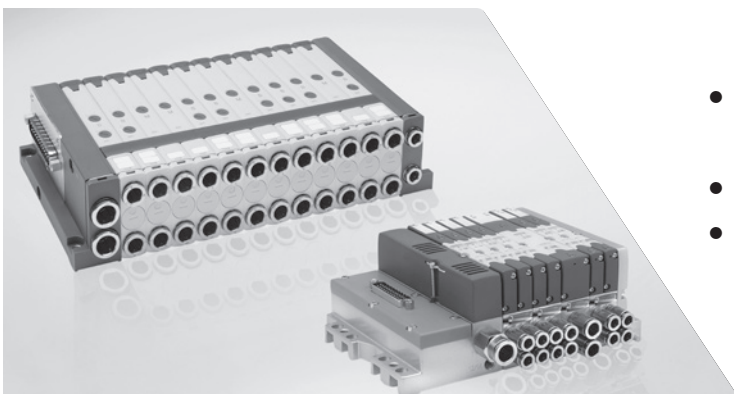





- Series HN (37 Pin, 32 Coils or 25 Pin, 24 Coils)
- Series F (25 Pin, 24 Coils)
- Next Day Delivery

Proportional Technology

1 Proportional Valves

	Page
 Series LR Digital Proportional Servo Valves	195

2 Proportional Regulators

	Page
 Series K8P Electronic Proportional Micro Regulator	196
 Series MX-PRO Proportional Pressure Regulator And Flow Valve	197
 Series ER100 Digital Electro-Pneumatic Regulators	198
 Series ER200 Digital Electro-Pneumatic Regulators	198

Series LR Digital Proportional Servo Valves

3/3-way directly operated servo valves for the flow (LRWD2), pressure (LRPD2) and position (LRXD2) control



Technical Data

Power Supply

24 VDC +/- 10%, max absorption 1.5 A

Command Signal

+/- 10 V

0-10 V

4-20 mA

Supply Pressure

-0.9 to 10 bar

Full Data Sheet and Dimensions at <https://store.camozzi.co.uk>

PROPORTIONAL TECHNOLOGY

CODING EXAMPLE

L	R	W	D	2	-	3	4	-	1	-	A	-	00
----------	----------	----------	----------	----------	----------	----------	----------	----------	----------	----------	----------	----------	-----------

L	<p>SERIES: L = proportional servo valves</p>	
R	<p>TECHNOLOGY: R = rotating spool</p>	
W	<p>VERSION: W = flow control P = pressure control X = position control</p>	
D	<p>ELECTRONICS: D = digital</p>	
2	<p>MODEL: 2 = compact DIN-RAIL</p>	
3	<p>FUNCTION: 3 = 3/3-way</p>	
4	<p>NOMINAL DIAMETER: 4 = 4 mm 6 = 6 mm</p>	
1	<p>COMMAND SIGNAL (Setpoint): 1 = +/- 10 V 2 = 0 - 10 V 5 = 4 - 20 mA</p>	
A	<p>INPUT SIGNAL: 2 = 0 - 10 V (LRPD2 and LRXD2 only) 4 = 0 - 5V (LRPD2 and LRXD2 only) 5 = 4 - 20mA (LRPD2 and LRXD2 only)</p>	<p>A = internal encoder (LRWD2 only) B = 1 bar (internal sensor - LRPD2 only) D = 10 bar (internal sensor - LRPD2 only) E = 250 mbar (internal sensor - LRPD2 only) F = +/-1 bar (internal sensor - LRPD2 only)</p>
00	<p>CABLE: 00 = no cable</p>	<p>2F = straight cable of 2 m 2R = 90° cable of 2 m 5F = straight cable of 5 m 5R = 90° cable of 5 m</p>

Please see our full catalogue for Series LR accessories.

Series K8P Electronic Proportional Micro Regulator

New: Use with Oxygen

Proportional regulator for pressure control

Series K8P electronic proportional micro regulators have evolved from our Series K8 mini-solenoid valves. Series K8P regulators guarantee excellent pressure regulation, fast response times, self regulation and low energy consumption. Series K8P is a high performance proportional pressure regulator which is suitable for use in all applications where high precision, quick response times and low consumption are required.

The K8P regulator adjusts the outlet pressure through the operation of two K8 monostable valves according to the inlet signal and to the retroactivity of the internal pressure sensor. A self-adjusting function has been integrated into the regulator control algorithm to guarantee the highest levels of performance apart from the volume connected.



- ✓ Ex Stock
- ✚ UK Assembly
- ☎ Please Call Sales Office

Part Number	Availability	Operating Pressure (Bar)
K8P-0-D5*2-0	☎	0-10
K8P-0-E5*2-0	☎	0-3
K8P-L-E5*2-0	☎	0-3
K8P-L-D5*2-0	☎	0-10
K8P-S-D5*2-0	☎	0-10
K8P-S-E5*2-0	☎	0-3
K8P-T-D5*2-0	☎	0-10
K8P-T-E5*2-0	☎	0-3

Technical Data

Fluids
 filtered compressed air, unlubricated, according to ISO 8573-1 class 7.4.4, oxygen, inert gases (argon, molecular nitrogen)

Pressures

Regulated pressure

0.5 - 10 bar

0.15 - 3 bar

0.35 - 7 bar

0.05 - 1 bar

Max inlet pressure

11 bar

4 bar

8 bar

1.5 bar

Analogue Input

0-10 V DC 4-20 mA Ripple ≤ 0,2%

In compliance with the European Directive 2004/108/EC

Full Data Sheet and Dimensions at <https://store.camozzi.co.uk>

PROPORTIONAL TECHNOLOGY

CODING EXAMPLE

K8P	-	0	-	D	5	2	2	-	0
-----	---	---	---	---	---	---	---	---	---

K8P	SERIES: K8P	
0	BODY DESIGN: 0 = Stand alone S = Standard Sub-base	L = Light Sub-base T = Light Sub-base for the pressure remote reading
D	WORKING PRESSURE: D = 0 - 10 bar E = 0 - 3 bar	F = 0 - 7 bar B = 0 - 1 bar
5	VALVE FUNCTIONS: 5 = 3/2-way NC	
2	COMMAND: 2 = 0-10 V DC 3 = 4-20 mA	
2	OUTPUT SIGNAL: 2 = 0-10 V	
0	CABLE LENGTH: 0 = without cable 2F = straight cable, 2 m 2R = right angle cable (90 degrees), 2 m	5F = straight cable, 5 m 5R = right angle cable (90 degrees), 5 m
OX1	VERSIONS: = standard OX1 = for use with oxygen (in compliance with ASTM G93-03 Level E)	
<p>APPLICATIONS The K8P proportional regulator can be used as a pilot valve to control the opening of high flow valves or to check the high flow pressure regulators proportionally (version with sub-base for the pressure remote reading). It enables proportional control of power in lifting systems and can be used with inert gas to maintain a constant pressure in pneumatic cylinders or expansion valve chambers.</p> <p>It has also been designed to maintain a constant pressure during the pulling power applied to the wires in winding machines, to modulate pressure during the smoothing process in woodworking machines or to adjust the opening of diaphragm valves.</p>		

Please see our full catalogue for Series K8P sub-bases and accessories.

Series MX-PRO Proportional Pressure Regulator and Proportional Flow Valve

New versions

Regulator and valve ports (standard and Manifold): G1/2
 Regulator: with built-in pressure gauge or G1/8 threaded ports
 Valve: without pressure gauge

Series MX-PRO electronic proportional pressure regulator is the result of combining advanced technology of Series K8P electronic proportional micro regulator, with reliability and high performance of Series MX2 modular regulators. This new regulator ensures high precision in pressure regulation, high flow rate and low consumption. Moreover, it can take the most of Series MX ease of assembly to provide particularly compact Manifolds.

Technical Data
PROPORTIONAL PRESSURE REGULATOR
Type of Construction
 Modular, compact, diaphragm type
Connections
 1/2
Regulated Pressure
 0.5 - 10 bar, 0.15 - 3 bar, 0.05 - 1 bar,
 0.35 - 7 bar
Analogical Input
 0-10 V DC Ripple ≤0.2%
 4 - 20mA

PROPORTIONAL FLOW VALVE
Type of Construction
 Modular, piston type
Connections
 1/2
Analogical Input
 0-10 V DC Ripple ≤0.2%
 4 - 20mA
 Full Data Sheet and Dimensions at
<https://store.camozzi.co.uk>



PROPORTIONAL TECHNOLOGY

☎ Please Call Sales Office

CODING EXAMPLE

MX	2	-	1/2	-	R	CV	2	0	4	-	LH
-----------	----------	----------	------------	----------	----------	-----------	----------	----------	----------	----------	-----------

MX	SERIES: MX
2	SIZE: 2 = G1/2
1/2	CONNECTIONS: 1/2 = G1/2
R	FUNCTIONING: R = pressure regulator M = Manifold pressure regulator V = flow valve W = Manifold flow valve
CV	COMMAND: CV = electrical command 0-10 V DC (regulator only) CA = electrical command 4-20 mA (regulator only) EV = electrical command 0-10 V DC with external servo pilot supply EA = electrical command 4-20 mA with external servo pilot supply
2	REGULATOR SETTING RANGE: 1 = working pressure 0 ÷ 3 bar 2 = working pressure 0 ÷ 10 bar 3 = working pressure 0 ÷ 1 bar 4 = working pressure 0 ÷ 7 bar VALVE SETTING RANGE: 8 = low flow 9 = high flow
0	DESIGN TYPE: 0 = relieving (regulator only) 1 = without relieving
4	PRESSURE GAUGE: 0 = without pressure gauge, with threaded port for gauges 2 = with built-in pressure gauge 0-6 bar (regulator only) 4 = with built-in pressure gauge 0-12 bar (regulator only)
LH	FLOW DIRECTION: = from left to right (standard) LH = from right to left
OX1	VERSIONS: = standard OX1 = for use with oxygen (in compliance with ASTM G93-03 Level E), FKM seals

Further details about the assembly of a single component with fixing flanges or wall-mounting can be found in the AIR TREATMENT catalogue, section SERIES MX ASSEMBLED FRL.

Please see our full catalogue for Series MX-PRO accessories and connectors.

Series ER100 and ER200 Digital Electro-Pneumatic Regulators

Series ER100 Connections: 1/4

Series ER200 Connections: 1/4 and 3/8

Full Data Sheet and Dimensions at <https://store.camozzi.co.uk>



SERIES ER100 MODELS

Part Number	Availability	Part Number	Availability
ER104-50AP	Ⓞ	ER104-90AP	Ⓞ
ER104-50SP	Ⓞ	ER104-90SP	Ⓞ
ER104-52AP	Ⓞ	ER104-92AP	Ⓞ
ER104-52SP	Ⓞ	ER104-92SP	Ⓞ
ER104-5PSP	Ⓞ	ER104-9PSP	Ⓞ

SERIES ER200 MODELS

Part Number	Availability	Part Number	Availability
ER238-50AP	Ⓞ	ER238-90AP	Ⓞ
ER238-50SP	Ⓞ	ER238-90SP	Ⓞ
ER238-52AP	Ⓞ	ER238-92AP	Ⓞ
ER238-52SP	Ⓞ	ER238-92SP	Ⓞ
ER238-5PSP	Ⓞ	ER238-9PSP	Ⓞ

CODING EXAMPLE

ER	1	04	-	5	0	AN
ER SERIES: ER		04 CONNECTIONS: 04 = 1/4 38 = 3/8 (size 2 only)			0 INPUT: 0 = 0 - 10 V DC 1 = 0 - 5 V DC 2 = 4 - 20 mA P = Parallel 10 bit	
	1 SIZE: 1 = size 1 2 = size 2			5 WORKING PRESSURE: 5 = 0 - 5 bar 9 = 0.5 - 9 bar		AN OUTPUT: AN = 1 - 5 V analog, error (NPN) AP = 1 - 5 V analog, error (PNP) SN = switch (NPN), error (NPN) SP = switch (PNP), error (PNP)

Please see our full technical catalogue for complete specifications.

Series ER100 Accessories

Bracket
Floor installation type

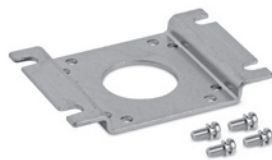

Part Number	Availability
ER1-B1	Ⓞ

Bracket
Wall installation type



Part Number	Availability
ER1-B2	Ⓞ

Series ER200 Accessories

Bracket
Floor installation type mounting



Part Number	Availability
ER2-B1	Ⓞ

Bracket
Wall installation type mounting



Part Number	Availability
ER2-B2	Ⓞ

Cable and connector for regulator
with analog Input



Part Number	Availability
G8X1-1	Ⓞ
G8X1-3	Ⓞ













Cable and connector for regulator
with parallel Input













Part Number	Availability
G8X2-1	Ⓞ
G8X2-3	Ⓞ

Air Treatment











1 Series MX Modular FRL Units

		Page
	Series MX Filters	202
	Series MX Activated Carbon Filters	203
	Series MX Coalescing Filters	204
	Series MX Pressure Regulators	205
	New Series MX Pneumatic Pilot Operated Pressure Regulators	207
	Series MX Lubricators	207
	Series MX Filter-Regulators	208
	Series MX Lockable Isolation 3/2-way Valves	210
	Series MX Soft Start Valves	210
	New Series MX SAFEMAX	211
	Series MX Take-off Blocks	212
	Series MX Assembled FRL	212
	Series MX Accessories	215

2 Series MC Modular FRL Units

		Page
	Series MC Filters	217
	New Series MC Activated Carbon Filters	217
	Series MC Coalescing Filters	218
	Series MC Lubricators	218
	Series MC Pressure Regulators	219
	Series MC Filter-Regulators	220
	Series MC Lockable Isolation 3/2-way Valves	221
	Series MC 3/2 Valves Pneumatically or Electropneumatically Operated	221
	Series MC Soft Start Valves	222
	Series MC Take-off Blocks	222
	Series MC Assembled FRL	223
	Series MC Assembly Manifold Pressure Regulators	226
	Series MC Accessories	227

3 Series MD Modular FRL Units

	Page
 Series MD Filters	228
 Series MD Activated Carbon Filters	228
 Series MD Coalescing Filters	229
 Series MD Lubricators	229
 Series MD Pressure Regulators	230
 Series MD Pressure Filter-Regulators	232
 Series MD Lockable Isolation 3/2-Way Valves	233
 Series MD Soft Start Valves	234
 Series MD Take-off Blocks	234
 Series MD Assembled FRL	235
 Series MD Accessories	238

4 Series N FRL Units

	Page
 Series N Filters And Coalescing Filters	239
 Series N Pressure Regulators	240
 Series N Lubricators	240
 Series N Filter-Regulators	241
 Series N Accessories	241





5 Pressure Regulators

	Page
 Series CLR Micro Pressure Regulators	242
 Series M Pressure Micro Regulators	243
 Series T Pressure Micro Regulators	244
 Series M, T Accessories for FRL	244
 Series PR Precision Regulators with Manual Override	245

6 Pressure Switches and Vacuum Switches

	Page
 Series PM, TRP, 2095 Pressure Switches, Transducers, Pressure Indicators	245
 New Series SWMN Electronic Vacuum/Pressure Switches In Mini Format	246
 Series SWDN Electronic Vacuum/Pressure Switches	247
 Series SWCN Electronic Vacuum/Pressure Switches	247
 Series GPB1 Pressure Switches	248
 Series GPB5 Pressure Switches	248

7 Accessories for Air Treatment

	Page
 Pressure Gauges	249
 Condensate Drains Filtering Elements	249
 Series PG Digital Pressure Gauges	250

New versions

Series MX Filters

Connections: MX2=3/8, 1/2, 3/4 MX3=3/4, 1

Modular

Bowl with technopolymer cover and bayonet-type mounting

Full Data Sheet and Dimensions at <https://store.camozzi.co.uk>

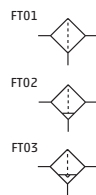



CODING EXAMPLE

MX	2	-	1/2	-	F	0	0	M	1	-	LH
----	---	---	-----	---	---	---	---	---	---	---	----

MX	SERIES: MX	0	DRAINING OF CONDENSATE: 0 = semi-automatic manual drain (standard - only for polymer bowl) 3 = automatic drain 5 = depressuring drain, protected (only for polymer bowl) 8 = without drain with connection 1/8
2	SIZE: 2 = 3/8 - 1/2 - 3/4 3 = 3/4 - 1	M	TYPE OF BOWL: = polymer (standard) M = metal (only for MX2-1/2 and MX3-1)
1/2	CONNECTIONS: 3/8, 1/2, 3/4, 1	1	VISUAL BLOCKAGE INDICATOR: = not present 1 = present
F	FILTER	LH	FLOW DIRECTION: = from left to right (standard) LH = from right to left
0	FILTERING ELEMENT: 0 = 25µm (standard) 1 = 5µm		

- ✓ Ex Stock
- 🔧 UK Assembly
- 📞 Please Call Sales Office

	Availability	Symbol	MX2			MX3	
			3/8	1/2	3/4	3/4	1
25 micron							
Semi Auto Drain	✓	FT02	MX2-3/8-F00	MX2-1/2-F00	MX2-3/4-F00	MX3-3/4-F00	MX3-1-F00
Automatic Drain	✓	FT03	MX2-3/8-F03	MX2-1/2-F03	MX2-3/4-F03	MX3-3/4-F03	MX3-1-F03
Depressurisation Drain Protected	📞	FT03	MX2-3/8-F05	MX2-1/2-F05	MX2-3/4-F05	MX3-3/4-F05	MX3-1-F05
Connection 1/8	📞	FT01	MX2-3/8-F08	MX2-1/2-F08	MX2-3/4-F08	MX3-3/4-F08	MX3-1-F08
5 micron							
Semi Auto Drain	✓	FT02	MX2-3/8-F10	MX2-1/2-F10	MX2-3/4-F10	MX3-3/4-F10	MX3-1-F10
Automatic Drain	✓	FT03	MX2-3/8-F13	MX2-1/2-F13	MX2-3/4-F13	MX3-3/4-F13	MX3-1-F13
Depressurisation Drain Protected	📞	FT03	MX2-3/8-F15	MX2-1/2-F15	MX2-3/4-F15	MX3-3/4-F15	MX3-1-F15
Connection 1/8	📞	FT01	MX2-3/8-F18	MX2-1/2-F18	MX2-3/4-F18	MX3-3/4-F18	MX3-1-F18
Accessories			3/8	1/2	3/4	3/4	
			S6510 10-3/8	S6510 12-1/2	S6510 16-3/4	S6510 16-3/4	
			S6520 10-3/8	S6520 12-1/2	-	-	

AIR TREATMENT

Series MX Activated Carbon Filters

New versions

Connections: MX2=3/8, 1/2, 3/4 MX3=3/4, 1

Modular

Bowl with technopolymer cover and bayonet-type mounting

Full Data Sheet and Dimensions at <https://store.camozzi.co.uk>

AIR TREATMENT





CODING EXAMPLE

MX	2	-	1/2	-	FCA	M	1	-	LH
-----------	----------	---	------------	---	------------	----------	----------	---	-----------

MX	SERIES: MX	
2	SIZE: 2 = 3/8 - 1/2 - 3/4 3 = 3/4 - 1	M TYPE OF BOWL: = Polymer (standard) M = metal (only for MX2-1/2 and MX3-1)
1/2	CONNECTIONS: 1/2, 3/4, 1	1 VISUAL BLOCKAGE INDICATOR: = not present 1 = present
FCA	ACTIVATED CARBON FILTER	LH FLOW DIRECTION: = from left to right (standard) LH = from right to left

- ✓ Ex Stock
- ✎ UK Assembly
- ⊗ Please Call Sales Office

	MX2			MX3		
Availability	3/8	1/2	3/4	3/4	1	
Activated Carbon Filters	⊗	MX2-3/8-FCA	MX2-1/2-FCA	MX2-3/4-FCA	MX3-3/4-FCA	MX3-1-FCA
Accessories	3/8	1/2	3/4	3/4		
	S6510 10-3/8	S6510 12-1/2	S6510 16-3/4	S6510 16-3/4		
	S6520 10-3/8	S6520 12-1/2	-	-		

Air Treatment Box Sets



Reduce costs and save time

- 1/2 & 3/8
- Removes Contaminants
- Controls Pressure
- Extends Component Service Life
- Increased Safety

New versions

Series MX Coalescing Filters

Connections: MX2=3/8, 1/2, 3/4 MX3=3/4, 1

Modular

Bowl with technopolymer cover and bayonet-type mounting

Full Data Sheet and Dimensions at <https://store.camozzi.co.uk>

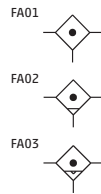

CODING EXAMPLE

MX 2 - 1/2 - FC 0 0 M 1 - LH

MX	SERIES: MX	
2	SIZE: 2 = 3/8 - 1/2 - 3/4 3 = 3/4 - 1	0 DRAINING OF CONDENSATE: 0 = semi-automatic manual drain (standard - only for polymer bowl) 3 = automatic drain 5 = depressuring drain, protected (only for polymer bowl) 8 = without drain with connection 1/8
1/2	CONNECTIONS: 3/8, 1/2, 3/4, 1	
FC	COALESCING FILTERS	M TYPE OF BOWL: = polymer (standard) M = metal (only for MX2-1/2 and MX3-1)
0	FILTERING ELEMENT: 0 = 0.01µm (standard) 1 = 1µm	1 VISUAL BLOCKAGE INDICATOR: = not present 1 = present
		LH FLOW DIRECTION: = from left to right (standard) LH = from right to left

- ✓ Ex Stock
- ✎ UK Assembly
- ⌚ Please Call Sales Office

	Availability	Symbol	3/8	MX2 1/2	3/4	MX3 3/4	1
0.01 micron							
Semi Auto Drain	⌚	FA02	MX2-3/8-FC00	MX2-1/2-FC00	MX2-3/4-FC00	MX3-3/4-FC00	MX3-1-FC00
Automatic Drain	⌚	FA03	MX2-3/8-FC03	MX2-1/2-FC03	MX2-3/4-FC03	MX3-3/4-FC03	MX3-1-FC03
Depressurisation Drain Protected	⌚	FA03	MX2-3/8-FC05	MX2-1/2-FC05	MX2-3/4-FC05	MX3-3/4-FC05	MX3-1-FC05
Connection 1/8	⌚	FA01	MX2-3/8-FC08	MX2-1/2-FC08	MX2-3/4-FC08	MX3-3/4-FC08	MX3-1-FC08
1 micron							
Semi Auto Drain	⌚	FA02	MX2-3/8-FC10	MX2-1/2-FC10	MX2-3/4-FC10	MX3-3/4-FC10	MX3-1-FC10
Automatic Drain	⌚	FA03	MX2-3/8-FC13	MX2-1/2-FC13	MX2-3/4-FC13	MX3-3/4-FC13	MX3-1-FC13
Depressurisation Drain Protected	⌚	FA03	MX2-3/8-FC15	MX2-1/2-FC15	MX2-3/4-FC15	MX3-3/4-FC15	MX3-1-FC15
Connection 1/8	⌚	FA01	MX2-3/8-FC18	MX2-1/2-FC18	MX2-3/4-FC18	MX3-3/4-FC18	MX3-1-FC18
Accessories							
			3/8	1/2	3/4	3/4	
			S6510 10-3/8	S6510 12-1/2	S6510 16-3/4	S6510 16-3/4	
			S6520 10-3/8	S6520 12-1/2	-	-	

Please see page 215 for additional Series MX accessories

Series MX Pressure Regulators

Connections: MX2=3/8, 1/2, 3/4, MX3=3/4, 1

Manifold Connections: 1/2 (MX2 only)

Modular - Available with built-in pressure gauge or connections for external gauge
(1/4 connection for MX3, 1/8 connection for MX2)

Full Data Sheet and Dimensions at <https://store.camozzi.co.uk>

AIR TREATMENT

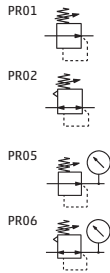

- ✓ Ex Stock
- 🇬🇧 UK Assembly
- 📞 Please Call Sales Office

CODING EXAMPLE

MX 2 - 3/8 - R 0 0 4 - LH

MX	SERIES: MX	0	DESIGN TYPE: 0 = relieving (standard) 1 = without relieving 2 = relieving, with by-pass valve (only regulator) 3 = without relieving, with by-pass valves (only regulator)
2	SIZE: 2 = 3/8 - 1/2 - 3/4 3 = 3/4 - 1		
3/8	CONNECTIONS: 3/8, 1/2, 3/4, 1		
R	TYPE OF REGULATOR: R = pressure regulator M = manifold pressure regulator (MX2 1/2 only)	4	PRESSURE GAUGE: 0 = without pressure gauge (with threaded connection for gauges) 2 = with built-in pressure gauge 0-6 and working pressure 0 - 4 bar 3 = with built-in pressure gauge 0-10 and working pressure 0 - 7 bar (MX2 only) 4 = with built-in pressure gauge 0-12 and working pressure 0.5 - 10 bar (standard)
0	OPERATING PRESSURE: 0 = 0.5 - 10 bar (standard) 4 = 0 - 4 bar 7 = 0.5 - 7 bar (MX2 only)	LH	FLOW DIRECTION: = from left to right (standard) LH = from right to left

Availability	Symbol	3/8	MX2		MX3	
			1/2	3/4	3/4	1
With Port for Pressure Gauge						
0.5 - 10 Bar, Relieving ✓	PR02	MX2-3/8-R000	MX2-1/2-R000	MX2-3/4-R000	MX3-3/4-R000	MX3-1-R000
0 - 4 Bar, Relieving 🕒	PR02	MX2-3/8-R400	MX2-1/2-R400	MX2-3/4-R400	MX3-3/4-R400	MX3-1-R400
0 - 7 Bar, Relieving (MX2 only) 🕒	PR02	MX2-3/8-R700	MX2-1/2-R700	MX2-3/4-R700	-	-
0.5 - 10 Bar, Non-Relieving 🕒	PR01	MX2-3/8-R010	MX2-1/2-R010	MX2-3/4-R010	MX3-3/4-R010	MX3-1-R010
0 - 4 Bar, Non-Relieving 🕒	PR01	MX2-3/8-R410	MX2-1/2-R410	MX2-3/4-R410	MX3-3/4-R410	MX3-1-R410
0 - 7 Bar, Non-Relieving (MX2 only) 🕒	PR01	MX2-3/8-R710	MX2-1/2-R710	MX2-3/4-R710	-	-
With Built-in Pressure Gauge						
0.5 - 10 Bar, Relieving ✓	PR06	MX2-3/8-R004	MX2-1/2-R004	MX2-3/4-R004	MX3-3/4-R004	MX3-1-R004
0 - 4 Bar, Relieving 🕒	PR06	MX2-3/8-R402	MX2-1/2-R402	MX2-3/4-R402	MX3-3/4-R402	MX3-1-R402
0 - 7 Bar, Relieving (MX2 only) 🕒	PR06	MX2-3/8-R703	MX2-1/2-R703	MX2-3/4-R703	-	-
0.5 - 10 Bar, Non-Relieving 🕒	PR05	MX2-3/8-R014	MX2-1/2-R014	MX2-3/4-R014	MX3-3/4-R014	MX3-1-R014
0 - 4 Bar, Non-Relieving 🕒	PR05	MX2-3/8-R412	MX2-1/2-R412	MX2-3/4-R412	MX3-3/4-R412	MX3-1-R412
0 - 7 Bar, Non-Relieving (MX2 only) 🕒	PR05	MX2-3/8-R713	MX2-1/2-R713	MX2-3/4-R713	-	-



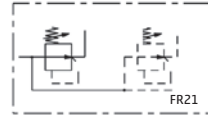

Accessories	3/8	1/2	3/4	3/4	1
	S6510 10-3/8	S6510 12-1/2	S6510 16-3/4	S6510 16-3/4	
	S6520 10-3/8	S6520 12-1/2	-	-	
	MX2-S	MX2-S	MX2-S	MX3-S	MX3-S
	M053-P12	M053-P12	M053-P12	M063-P12	M063-P12

Please see page 215 for additional Series MX accessories

Series MX Manifold Pressure Regulators



- ✓ Ex Stock
- 🔧 UK Assembly
- 📞 Please Call Sales Office

Availability	Symbol	MX2 1/2
With Port for Pressure Gauge		
0.5 - 10 Bar, Relieving ✓	FR19	MX2-1/2-M000
0 - 4 Bar, Relieving 📞	FR19	MX2-1/2-M400
0 - 7 Bar, Relieving 📞	FR19	MX2-1/2-M700
0.5 - 10 Bar, Non-Relieving 📞	FR21	MX2-1/2-M010
0 - 4 Bar, Non-Relieving 📞	FR21	MX2-1/2-M410
0 - 7 Bar, Non-Relieving 📞	FR21	MX2-1/2-M710
With Built-in Pressure Gauge		
0.5 - 10 Bar, Relieving 📞	FR20	MX2-1/2-M004
0 - 4 Bar, Relieving 📞	FR20	MX2-1/2-M402
0 - 7 Bar, Relieving 📞	FR20	MX2-1/2-M703
0.5 - 10 Bar, Non-Relieving 📞	FR22	MX2-1/2-M014
0 - 4 Bar, Non-Relieving 📞	FR22	MX2-1/2-M412
0 - 7 Bar, Non-Relieving 📞	FR22	MX2-1/2-M713
Accessories		
1/2		
		S6510 12-1/2
		S6520 12-1/2
		MX2-S
		M053-P12

Please see page 215 for additional Series MX accessories

Series MX Pneumatic Pilot Operated Pressure Regulators

New

Connections: 3/8, 1/2, 3/4

Modular - Available with built-in pressure gauge or connections for gauge.

Full Data Sheet and Dimensions at <https://store.camozzi.co.uk>

AIR TREATMENT



CODING EXAMPLE

MX 2 - 1/2 - R CP 0 0 4 - LH

MX	SERIES: MX	0	OPERATING PRESSURE: 0 = 0.5 - 10 bar
2	SIZE: 2 = 3/8 - 1/2 - 3/4		
3/8	CONNECTIONS: 3/8, 1/2, 3/4		DESIGN TYPE: 0 = relieving (standard) 1 = without relieving
R	TYPE OF REGULATOR: R = pressure regulator	4	PRESSURE GAUGE: 0 = without pressure gauge (with threaded connection for gauges) 4 = with built-in pressure gauge 0-12 and working pressure 0.5 - 10 bar (standard)
CP	TYPE OF COMMAND/PILOT SUPPLY: CP = pneumatic pilot supply	LH	FLOW DIRECTION: = from left to right (standard) LH = from right to left

- ✓ Ex Stock
- ✎ UK Assembly
- ☎ Please Call Sales Office

Availability	3/8	1/2	3/4
Part Number	✓ MX2-3/8-RCP004	MX2-1/2-RCP004	MX2-3/4-RCP004

Please see page 215 for Series MX Accessories

Series MX Lubricators

New versions

Connections: MX2=3/8, 1/2, 3/4 MX3=3/4, 1

Note: Lubrication Oil also available

Modular

Bowl with technopolymer cover and bayonet-type mounting

Full Data Sheet and Dimensions at <https://store.camozzi.co.uk>



CODING EXAMPLE

MX 2 - 1/2 - L 00 M - LH

MX	SERIES: MX		
2	SIZE: 2 = 3/8 - 1/2 - 3/4 3 = 3/4 - 1	00	DESIGN TYPE: 00 = atomized oil
1/2	CONNECTIONS: 3/8, 1/2, 3/4, 1	M	TYPE OF BOWL: = polymer (standard) M = metal (for MX2-1/2 and mx3-1 only)
L	LUBRICATOR	LH	FLOW DIRECTION: = from left to right (standard) LH = from right to left



- ✓ Ex Stock
- ✎ UK Assembly
- ☎ Please Call Sales Office

Availability	MX2	MX3			
Connection	3/8	1/2	3/4	3/4	1
Part Number	✓ MX2-3/8-L00	MX2-1/2-L00	MX2-3/4-L00	MX3-3/4-L00	MX3-1-L00

Please see page 215 for Series MX Accessories

New versions

Series MX Filter/Regulators

Connections: MX2=3/8, 1/2, 3/4 MX3=3/4, 1

Modular

Bowl with technopolymer cover and bayonet-type mounting

Full Data Sheet and Dimensions at <https://store.camozzi.co.uk>

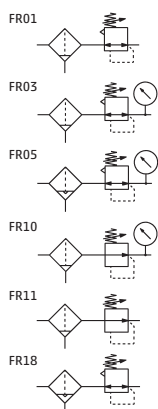

N.B. 5 Micron, depressurisation drain and connection 1/8 also available on request. See coding table above.

Please see page 215 for Series MX Accessories

CODING EXAMPLE

MX | **2** | - | **1/2** | - | **FR** | **0** | **0** | **0** | **4** | **M** | - | **LH**

MX SERIES: MX	0 DRAINING OF CONDENSATE: 0 = semi-automatic manual drain (standard - only for polymer bowl) 3 = automatic drain 5 = depressuring drain, protected (only for polymer bowl) 8 = without drain with connection 1/8
2 SIZE: 2 = 3/8 - 1/2 - 3/4 3 = 3/4 - 1	0 OPERATING PRESSURE: 0 = 0.5 - 10 bar (standard) 4 = 0 - 4 bar 7 = 0.5 - 7 bar (MX2 only)
3/8 CONNECTIONS: 3/8, 1/2, 3/4, 1	4 PRESSURE GAUGE: 0 = without pressure gauge 2 = with built-in pressure gauge 0-6 and working pressure 0-4 bar 3 = with built-in pressure gauge 0-10 and working pressure 0-7 bar (MX2 only) 4 = with built-in pressure gauge 0-12 and working pressure 0.5 - 10 bar (standard)
FR FILTER REGULATOR	
0 FILTERING ELEMENT WITH DESIGN TYPE: 0 = 25µm with relieving (standard) 1 = 5µm with relieving 2 = 25µm without relieving 3 = 5µm without relieving	M TYPE OF BOWL: = polymer (standard) M = metal (only for MX2-1/2 and MX3-1)
	LH FLOW DIRECTION: = from left to right (standard) LH = from right to left

AIR TREATMENT



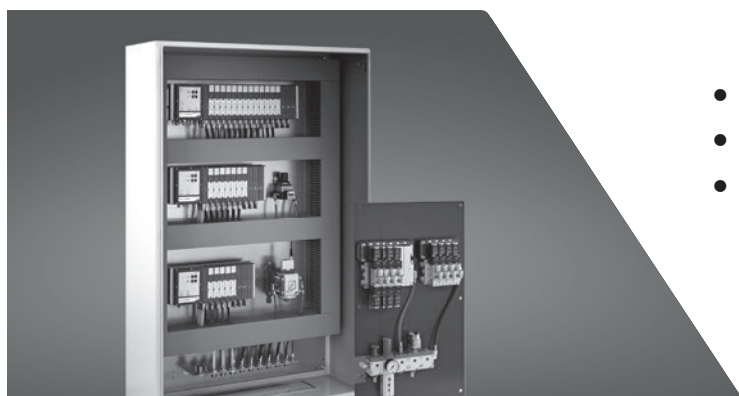

Customised Solutions



- Pre-Assembled Kits
- Special Products
- Control Cabinets and Systems

Series MX Filter/Regulator

- ✓ Ex Stock
- 🔧 UK Assembly
- 📞 Please Call Sales Office

Availability Symbol			MX2			MX3	
		3/8	1/2	3/4	3/4	1	
Semi Auto Drain - Self Relieving							
25 Micron 0.5 - 10 Bar	✓	FR01	MX2-3/8-FR0000	MX2-1/2-FR0000	MX2-3/4-FR0000	MX3-3/4-FR0000	MX3-1-FR0000
25 Micron 0 - 4 Bar	📞	FR01	MX2-3/8-FR0040	MX2-1/2-FR0040	MX2-3/4-FR0040	MX3-3/4-FR0040	MX3-1-FR0040
25 Micron 0.5 - 10 Bar (MX2 only)	📞	FR01	MX2-3/8-FR0070	MX2-1/2-FR0070	MX2-3/4-FR0070	-	-
Semi Auto Drain - Non-Relieving							
25 Micron 0.5 - 10 Bar	✓	FR011	MX2-3/8-FR2000	MX2-1/2-FR2000	MX2-3/4-FR0000	MX3-3/4-FR2000	MX3-1-FR2000
25 Micron 0 - 4 Bar	📞	FR011	MX2-3/8-FR2040	MX2-1/2-FR2040	MX2-3/4-FR0040	MX3-3/4-FR2040	MX3-1-FR2040
25 Micron 0 - 7 Bar (MX2 only)	📞	FR011	MX2-3/8-FR2070	MX2-1/2-FR2070	MX2-3/4-FR0070	-	-
Automatic Drain - Self Relieving							
25 Micron 0.5 - 10 Bar	✓	FR018	MX2-3/8-FR0300	MX2-1/2-FR0300	MX2-3/4-FR0300	MX3-3/4-FR0300	MX3-1-FR0300
25 Micron 0 - 4 Bar	📞	FR018	MX2-3/8-FR0340	MX2-1/2-FR0340	MX2-3/4-FR0340	MX3-3/4-FR0340	MX3-1-FR0340
25 Micron 0 - 7 Bar (MX2 only)	📞	FR018	MX2-3/8-FR0370	MX2-1/2-FR0370	MX2-3/4-FR0370	-	-
Semi Auto Drain - Self Relieving							
25 Micron 0.5 - 10 Bar	✓	FR03	MX2-3/8-FR0004	MX2-1/2-FR0004	MX2-3/4-FR0004	MX3-3/4-FR0004	MX3-1-FR0004
25 Micron 0 - 4 Bar	📞	FR03	MX2-3/8-FR0042	MX2-1/2-FR0042	MX2-3/4-FR0042	MX3-3/4-FR0042	MX3-1-FR0042
25 Micron 0.5 - 10 Bar (MX2 only)	📞	FR03	MX2-3/8-FR0073	MX2-1/2-FR0073	MX2-3/4-FR0073	-	-
Semi Auto Drain - Non-Relieving							
25 Micron 0.5 - 10 Bar	📞	FR10	MX2-3/8-FR2004	MX2-1/2-FR2004	MX2-3/4-FR2004	MX3-3/4-FR2004	MX3-1-FR2004
25 Micron 0 - 4 Bar	📞	FR10	MX2-3/8-FR2042	MX2-1/2-FR2042	MX2-3/4-FR2042	MX3-3/4-FR2042	MX3-1-FR2042
25 Micron 0 - 7 Bar (MX2 only)	📞	FR10	MX2-3/8-FR2073	MX2-1/2-FR2073	MX2-3/4-FR2073	-	-
Automatic Drain - Self Relieving							
25 Micron 0.5 - 10 Bar	✓	FR05	MX2-3/8-FR0304	MX2-1/2-FR0304	MX2-3/4-FR0304	MX3-3/4-FR0304	MX3-1-FR0304
25 Micron 0 - 4 Bar	📞	FR05	MX2-3/8-FR0342	MX2-1/2-FR0342	MX2-3/4-FR0342	MX3-3/4-FR0342	MX3-1-FR0342
25 Micron 0 - 7 Bar (MX2 only)	📞	FR05	MX2-3/8-FR0373	MX2-1/2-FR0373	MX2-3/4-FR0373	-	-
Accessories							
		3/8	1/2	3/4	3/4		
		S6510 10-3/8	S6510 12-1/2	S6510 16-3/4	S6510 16-3/4		
		S6520 10-3/8	S6520 12-1/2	-	-		
		MX2-S	MX2-S	MX2-S	MX3-S	MX3-S	
		M053-P12	M053-P12	M053-P12	M063-P12	M063-P12	

Please see page 215 for additional Series MX accessories

Series MX Lockable Isolation 3/2-Way Valves

Connections: MX2=3/8, 1/2, 3/4 MX3=3/4, 1

Modular

Manual, electro-pneumatic, servo-pilot and pneumatic control

Full Data Sheet and Dimensions at <https://store.camozzi.co.uk>

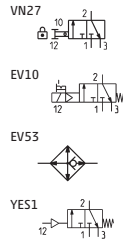
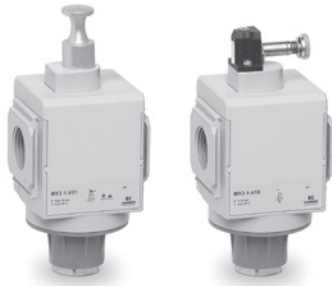

- ✓ Ex Stock
- ✎ UK Assembly
- ☎ Please Call Sales Office

CODING EXAMPLE

MX	2	-	3/8	-	V	01	-	LH
----	---	---	-----	---	---	----	---	----

MX	SERIES: MX	V	3/2 WAY VALVE
2	SIZE: 2 = 3/8 - 1/2 - 3/4 3 = 3/4 - 1	01	DESIGN TYPE: 01 = lockable manual control 16 = electro-pneumatic control 17 = servo-pilot control 36 = pneumatic control
3/8	CONNECTIONS: 3/8, 1/2, 3/4, 1	LH	FLOW DIRECTION: = from left to right (standard) LH = from right to left

		MX2			MX3	
Availability Symbol		3/8	1/2	3/4	3/4	1
Lockable Manual Control	✓ VN27	MX2-3/8-V01	MX2-1/2-V01	MX2-3/4-V01	MX3-3/4-V01	MX3-1-V01
Electro-Pneumatic Control	✓ EV10	MX2-3/8-V16	MX2-1/2-V16	MX2-3/4-V16	MX3-3/4-V16	MX3-1-V16
Servo-Pilot Control	✓ EV53	MX2-3/8-V17	MX2-1/2-V17	MX2-3/4-V17	MX3-3/4-V17	MX3-1-V17
Pneumatic Control	✓ YES1	MX2-3/8-V36	MX2-1/2-V36	MX2-3/4-V36	MX3-3/4-V36	MX3-1-V36

Accessories		3/8	1/2	3/4	3/4
		S6510 10-3/8	S6510 12-1/2	S6510 16-3/4	S6510 16-3/4
		S6520 10-3/8	S6520 12-1/2	-	-
	Note: Required for Electro-Pneumatic Control Only	U7*	U7*	U7*	U7*

Please see page 133 for voltage options

Please see page 215 for additional Series MX accessories

Series MX Soft Start Valves

Connections: MX2=3/8, 1/2, 3/4 MX3=3/4, 1

Modular

Full Data Sheet and Dimensions at <https://store.camozzi.co.uk>

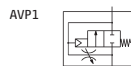

- ✓ Ex Stock
- ✎ UK Assembly
- ☎ Please Call Sales Office

CODING EXAMPLE

MX	2	-	3/8	-	AV	-	LH
----	---	---	-----	---	----	---	----

MX	SERIES: MX	AV	SOFT START VALVE
2	SIZE: 2 = 3/8 - 1/2 - 3/4 3 = 3/4 - 1	LH	FLOW DIRECTION: = from left to right (standard) LH = from right to left
3/8	CONNECTIONS: 3/8, 1/2, 3/4, 1		

		MX2			MX3	
Availability		3/8	1/2	3/4	3/4	1
Soft Start Valve	✓	MX2-3/8-AV	MX2-1/2-AV	MX2-3/4-AV	MX3-3/4-AV	MX3-1-AV

Please see page 215 for additional Series MX accessories

New

Series MX SAFEMAX

Connections: 1/2

Single or double channel

These safety valves have been designed to provide a plug & play solution for OEMs to be compliant with Machine Directive ISO 13849

Full Data Sheet and Dimensions at <https://store.camozzi.co.uk>





AIR TREATMENT

CODING EXAMPLE

MX	2	-	1/2	-	V	16	2	0	A	B	-	-
-----------	----------	---	------------	---	----------	-----------	----------	----------	----------	----------	---	---

MX	SERIES: MC	0	ACCESSORY: 0 = Without silencer 1 = With silencer
2	SIZE: 2 = 1/2	A	SENSOR: A = UL sensor L = 2mt cable B = UL sensor L = 5mt cable C = Atex sensor L = 2mt cable D = Atex sensor L = 5mt cable E = CE sensor M8 connector
1/2	CONNECTIONS: 1/2	B	VERSION: A = Atex B = UL C = CE
V	SOLENOID VALVE	16	CONSTRUCTION: 16 = Internal Servo Piloting 17 = External Servo Piloting
2	CHANNEL: 2 = Single 4 = Double		FLOW DIRECTION: = From Left to Right LH = From Right to Left

Accessories	1/2	3/4	3/4
	S6510 12-1/2	S6510 16-3/4	S6510 16-3/4
	S6520 12-1/2	-	-

Please see page 215 for additional Series MX accessories

Series MX Take-off Blocks

Connections: MX2=1/2 MX3=1

Modular

Full Data Sheet and Dimensions at <https://store.camozzi.co.uk>

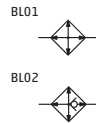

- ✓ Ex Stock
- ✎ UK Assembly
- ☎ Please Call Sales Office

CODING EXAMPLE

MX	2	-	1/2	-	B	00	-	LH
-----------	----------	----------	------------	----------	----------	-----------	----------	-----------

MX	SERIES: MX		
2	SIZE: 2 = 1/2 3 = 1	00	DESIGN TYPE: 00 = without no return valve (standard) 01 = with no return valve 02 = without no return valve, with double O-ring seat
1/2	CONNECTIONS: 1/2, 1		
B	TAKE-OFF BLOCK	LH	FLOW DIRECTION: = from left to right (standard) LH = from right to left

	Availability	Symbol	MX2	MX3
Take-off Blocks			1/2	1
Without no return valve	✓	BL01	MX2-1/2-B00	MX3-1-B00
With no return valve	✓	BL02	MX2-1/2-B01	MX3-1-B01

Please see page 215 for Series MX Accessories

Series MX FRL Assembled

Connections MX2=3/8, 1/2, 3/4 MX3=3/4, 1

Assembly through rapid clamps

The FRL Series MX can be easily assembled through rapid clamps which allow the connection among single components creating an unlimited number of compositions.

The FRL groups Series MX are also available in the already mounted version (with a single code).

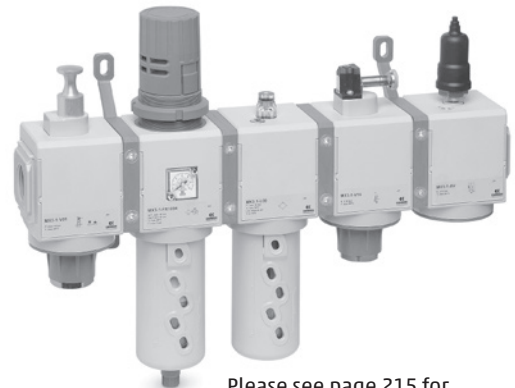

Please see page 215 for additional Series MX accessories

CODING EXAMPLE

MX	2	-	3/8	-	000014	-	LH
-----------	----------	----------	------------	----------	---------------	----------	-----------

MX	SERIES: MX		
2	SIZE: 2 = 3/8 - 1/2 - 3/4 3 = 3/4 - 1	000014	GROUP COMPOSITION (WITH BUILT IN PRESSURE GAUGE): 000014 = F00 + R004 + L00 000015 = FR0004 + L00 000016 = V01 + FR0004 + L00 000017 = V01 + FR0004 000018 = FR0004 + V16 + AV 000019 = FR0004 + L00 + V16 + AV 000020 = V01 + FR0004 + V16 + AV 000021 = V01 + FR0004 + L00 + V16 + AV + PRESS. NO 000022 = V01 + FR0004 + L00 + V16 + AV + PRESS. NC 000023 = V01 + FR0004 + V16 + AV + PRESS. NO 000024 = V01 + FR0004 + V16 + AV + PRESS. NC GROUP COMPOSITION (WITH EXTERNAL PRESSURE GAUGE): 000025 = F00 + R000 + L00 000026 = FR0000 + L00 000027 = V01 + FR0000 + L00 000028 = V01 + FR0000 000029 = FR0000 + V16 + AV 000030 = FR0000 + L00 + V16 + AV 000031 = V01 + FR0000 + V16 + AV 000032 = V01 + FR0000 + L00 + V16 + AV + PRESS. NO 000033 = V01 + FR0000 + L00 + V16 + AV + PRESS. NC 000034 = V01 + FR0000 + V16 + AV + PRESS. NO 000035 = V01 + FR0000 + V16 + AV + PRESS. NC 000036 = F13 + FC03
3/8	CONNECTIONS: 3/8 = 3/8 1/2 = 1/2 3/4 = 3/4 1 = 1		
			LH FLOW DIRECTION: = from left to right (standard) LH = from right to left

Composition of the assembled group 000014 and 000025

- Components:
Filter
Regulator
Lubricator
Pressure Gauge
Bracket

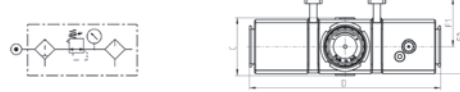
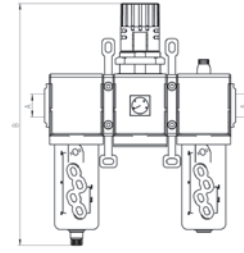

- ✓ Ex Stock
- ✎ UK Assembly
- ⓞ Please Call Sales Office

WITH BUILT IN PRESSURE GAUGE							
Part Number	Availability	A	B	C	D	F1	F2
MX2-3/8-000014	✎	3/8	289	74.5	210	70	104.5
MX2-1/2-000014	✎	1/2	289	74.5	210	70	104.5
MX2-3/4-000014	✎	3/4	289	74.5	210	70	104.5
MX3-3/4-000014	✎	3/4	345	81	268.5	68	106
MX3-1-000014	✎	1	345	81	268.5	68	106

WITH EXTERNAL PRESSURE GAUGE							
Part Number	Availability	A	B	C	D	F1	F2
MX2-3/8-000025	✎	3/8	289	74.5	210	70	104.5
MX2-1/2-000025	✎	1/2	289	74.5	210	70	104.5
MX2-3/4-000025	✎	3/4	289	74.5	210	70	104.5
MX3-3/4-000025	✎	3/4	345	81	268.5	68	106
MX3-1-000025	✎	1	345	81	268.5	68	106

Composition of the assembled group 000015 and 000026

- Components:
Filter-regulator
Lubricator
Pressure Gauge
Bracket

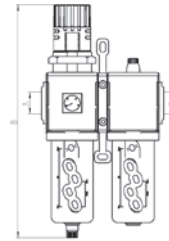

- ✓ Ex Stock
- ✎ UK Assembly
- ⓞ Please Call Sales Office

WITH BUILT IN PRESSURE GAUGE							
Part Number	Availability	A	B	C	D	F1	F2
MX2-1/2-000015	✎	3/8	289	74.5	140	70	104.5
MX2-3/8-000015	✎	1/2	289	74.5	140	70	104.5
MX2-3/4-000015	✎	3/4	289	74.5	140	70	104.5
MX3-3/4-000015	✎	3/4	345	81	179	68	106
MX3-1-000015	✎	1	345	81	179	68	106

WITH EXTERNAL PRESSURE GAUGE							
Part Number	Availability	A	B	C	D	F1	F2
MX2-1/2-000026	✎	3/8	289	74.5	140	70	104.5
MX2-3/8-000026	✎	1/2	289	74.5	140	70	104.5
MX2-3/4-000026	✎	3/4	289	74.5	140	70	104.5
MX3-3/4-000026	✎	3/4	345	81	179	68	106
MX3-1-000026	✎	1	345	81	179	68	106

Composition of the assembled group 000016 and 000027

- Components:
Lockable isolation 3/2 valve
Filter-regulator
Lubricator
Pressure Gauge
Bracket

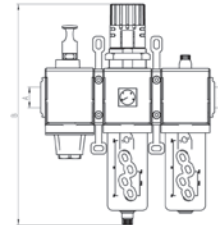
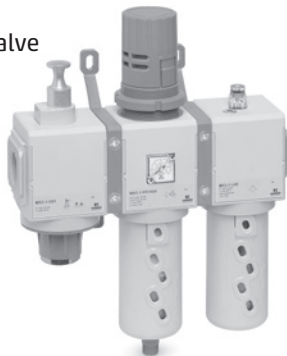

- ✓ Ex Stock
- ✎ UK Assembly
- ⓞ Please Call Sales Office

WITH BUILT IN PRESSURE GAUGE							
Part Number	Availability	A	B	C	D	F1	F2
MX2-3/8-000016	✎	3/8	289	74.5	210	70	104.5
MX2-1/2-000016	✎	1/2	289	74.5	210	70	104.5
MX2-3/4-000016	✎	3/4	289	74.5	210	70	104.5
MX3-3/4-000016	✎	3/4	345	81	268.5	68	106
MX3-1-000016	✎	1	345	81	268.5	68	106

WITH EXTERNAL PRESSURE GAUGE							
Part Number	Availability	A	B	C	D	F1	F2
MX2-3/8-000027	✎	3/8	289	74.5	210	70	104.5
MX2-1/2-000027	✎	1/2	289	74.5	210	70	104.5
MX2-3/4-000027	✎	3/4	289	74.5	210	70	104.5
MX3-3/4-000027	✎	3/4	345	81	268.5	68	106
MX3-1-000027	✎	1	345	81	268.5	68	106

Please see page 215 for Series MX Accessories

Composition of the assembled group 000017 and 000028

- Components:
- Lockable isolation 3/2 valve
- Filter-regulator
- Pressure Gauge
- Bracket

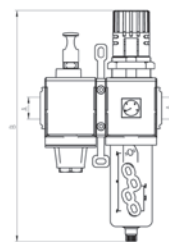

- ✓ Ex Stock
- ✎ UK Assembly
- ⦿ Please Call Sales Office

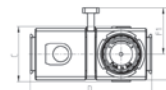

WITH BUILT IN PRESSURE GAUGE							
Part Number	Availability	A	B	C	D	F1	F2
MX2-3/8-000017	✎	3/8	289	74.5	140	70	104.5
MX2-1/2-000017	✎	1/2	289	74.5	140	70	104.5
MX2-3/4-000017	✎	3/4	289	74.5	140	70	104.5
MX3-3/4-000017	✎	3/4	345	81	179	68	106
MX3-1-000017	✎	1	345	81	179	68	106

WITH EXTERNAL PRESSURE GAUGE							
Part Number	Availability	A	B	C	D	F1	F2
MX2-3/8-000028	✎	3/8	289	74.5	140	70	104.5
MX2-1/2-000028	✎	1/2	289	74.5	140	70	104.5
MX2-3/4-000028	✎	3/4	289	74.5	140	70	104.5
MX3-3/4-000028	✎	3/4	345	81	179	68	106
MX3-1-000028	✎	1	345	81	179	68	106

Composition of the assembled group 000018 and 000029

- Components:
- Filter-regulator
- Lockable isolation 3/2 valve
- Soft start valve
- Pressure Gauge
- Bracket

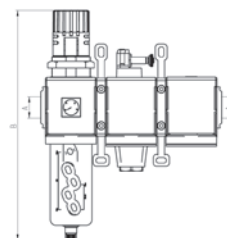

- ✓ Ex Stock
- ✎ UK Assembly
- ⦿ Please Call Sales Office

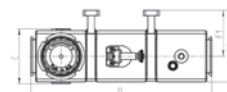

WITH BUILT IN PRESSURE GAUGE							
Part Number	Availability	A	B	C	D	F1	F2
MX2-3/8-000018	✎	3/8	289	74.5	210	70	104.5
MX2-1/2-000018	✎	1/2	289	74.5	210	70	104.5
MX2-3/4-000018	✎	3/4	289	74.5	210	70	104.5
MX3-3/4-000018	✎	3/4	345	81	268.5	68	106
MX3-1-000018	✎	1	345	81	268.5	68	106

WITH EXTERNAL PRESSURE GAUGE							
Part Number	Availability	A	B	C	D	F1	F2
MX2-3/8-000029	✎	3/8	289	74.5	210	70	104.5
MX2-1/2-000029	✎	1/2	289	74.5	210	70	104.5
MX2-3/4-000029	✎	3/4	289	74.5	210	70	104.5
MX3-3/4-000029	✎	3/4	345	81	268.5	68	106
MX3-1-000029	✎	1	345	81	268.5	68	106

Composition of the assembled group 000019 and 000030

- Components:
- Filter-regulator
- Lubricator
- Lockable isolation 3/2 valve
- Soft start valve
- Pressure Gauge
- Bracket

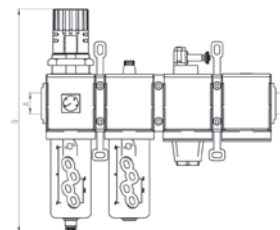
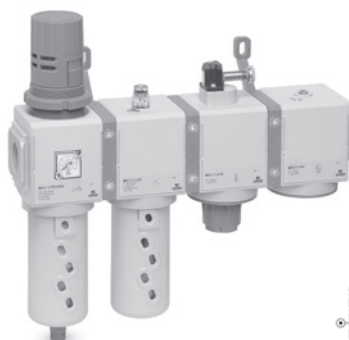

- ✓ Ex Stock
- ✎ UK Assembly
- ⦿ Please Call Sales Office

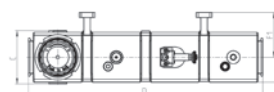

WITH BUILT IN PRESSURE GAUGE							
Part Number	Availability	A	B	C	D	F1	F2
MX2-3/8-000019	✎	3/8	289	74.5	280	70	104.5
MX2-1/2-000019	✎	1/2	289	74.5	280	70	104.5
MX2-3/4-000019	✎	3/4	289	74.5	280	70	104.5
MX3-3/4-000019	✎	3/4	345	81	358	68	106
MX3-1-000019	✎	1	345	81	358	68	106

WITH EXTERNAL PRESSURE GAUGE							
Part Number	Availability	A	B	C	D	F1	F2
MX2-3/8-000030	✎	3/8	289	74.5	280	70	104.5
MX2-1/2-000030	✎	1/2	289	74.5	280	70	104.5
MX2-3/4-000030	✎	3/4	289	74.5	280	70	104.5
MX3-3/4-000030	✎	3/4	345	81	358	68	106
MX3-1-000030	✎	1	345	81	358	68	106

Please see page 215 for Series MX Accessories

Composition of the assembled group 000020 and 000031

- Components:
 Lockable isolation 3/2 valve
 Filter-regulator
 Lockable isolation 3/2 valve
 Soft start valve
 Pressure Gauge
 Bracket

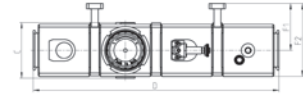
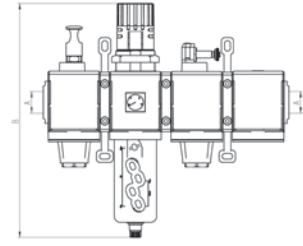

- ✓ Ex Stock
- ✎ UK Assembly
- ⊗ Please Call Sales Office

WITH BUILT IN PRESSURE GAUGE							
Part Number	Availability	A	B	C	D	F1	F2
MX2-3/8-000020	✎	3/8	289	74.5	280	70	104.5
MX2-1/2-000020	✎	1/2	289	74.5	280	70	104.5
MX2-3/4-000020	✎	3/4	289	74.5	280	70	104.5
MX3-3/4-000020	✎	3/4	345	81	358	68	106
MX3-1-000020	✎	1	345	81	358	68	106

WITH EXTERNAL PRESSURE GAUGE							
Part Number	Availability	A	B	C	D	F1	F2
MX2-3/8-000031	✎	3/8	289	74.5	280	70	104.5
MX2-1/2-000031	✎	1/2	289	74.5	280	70	104.5
MX2-3/4-000031	✎	3/4	289	74.5	280	70	104.5
MX3-3/4-000031	✎	3/4	345	81	358	68	106
MX3-1-000031	✎	1	345	81	358	68	106

Composition of the assembled group 000036

- Components:
 Filter
 Coalescing filter
 Bracket

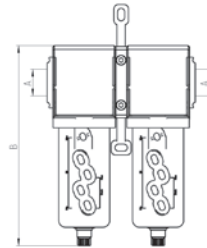

- ✓ Ex Stock
- ✎ UK Assembly
- ⊗ Please Call Sales Office

FILTER SET							
Part Number	Availability	A	B	C	D	F1	F2
MX2-3/8-000036	✎	3/8	210	72	140	70	104.5
MX2-1/2-000036	✎	1/2	210	72	140	70	104.5
MX2-3/4-000036	✎	3/4	210	72	140	70	104.5
MX3-3/4-000036	✎	3/4	231	78	179	68	106
MX3-1-000036	✎	1	231	78	179	68	106

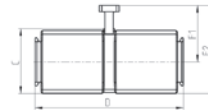

Please see below for Series MX Accessories

Series MX Accessories for FRL

- ✓ Ex Stock
- ✎ UK Assembly
- ⊗ Please Call Sales Office

Rapid Clamp Kit for Series MX - Size 2

Kit MX2-X supplied with: 1 rapid clamp, 1 O-ring OR 3125**, 2 hexagonal nuts M5, 2 screws M5x69.
 Kit MX2-Z supplied with: 1 rapid clamp, 1 O-ring OR 3125**, 1 hexagonal nut M5, 1 screw M5x69, 1 screw M5x85 for wall fixing.

** it can be ordered separately (cod. 160-39-11/19)

Materials: technopolymer clamp, NBR O-ring, zinc-plated stainless steel nuts and screws.

Part Number	Availability
MX2-X	✓
MX2-Z*	✓

*kit with wall fixing screw



Rapid Clamp Kit for Series MX - Size 3

Kit MX3-X supplied with: 1 rapid clamp, 1 O-ring OR 3150 **, 2 square nuts M6, 2 screws M6x75.
 Kit MX3-Z supplied with: 1 rapid clamp, 1 O-ring OR 3150 **, 1 square nut M6, 1 screw M6x75, 1 screw M6x90 for wall fixing.

** it can be ordered separately (cod. C401-F33)

Materials: technopolymer clamp, NBR O-ring, zinc-plated stainless steel nuts and screws.

Part Number	Availability
MX3-X	✓
MX3-Z	✓



Rapid Clamp Kit with wall fixing brackets for Series MX - Size 2

The kit MX2-Y is supplied with:
1 wall rapid clamp, 1 O-ring OR 3125 **, 2 hexagonal nuts, 2 screws M5x69.

** it can be separately ordered (cod. 160-39-11/19)

Materials: technopolymer clamp, NBR O-ring, zinc-plated stainless steel nuts and screws.



Part Number	Availability
MX2-Y	✓

Rapid Clamp Kit with wall fixing brackets for Series MX - Size 3

The kit MX3-Y is supplied with:
1 wall rapid clamp, 1 O-ring OR 3150 **, 2 square nuts M6, 2 screws M6x75

** it can be also separately ordered (cod. C401-F33)

Materials: technopolymer clamp, NBR O-ring, zinc-plated stainless steel nuts and screws.



Part Number	Availability
MX3-Y	✓

Terminal Flanges (IN/OUT) for Series MX

The kit is supplied with:
- 1 flange INLET side
- 1 flange OUTLET side

Materials: painted aluminium flanges.



Part Number	Availability
MX2-3/8-FL	✓
MX2-1/2-FL	✓
MX2-3/4-FL	✓
MX3-3/4-FL	✓
MX3-1-FL	✓

Fixing bracket for regulators Series MX

The kit is supplied with 1 zinc-plated stainless steel bracket



Part Number	Availability
MX2-S	✓
MX3-S	✓

Rapid clamps kit + flanges for Series MX

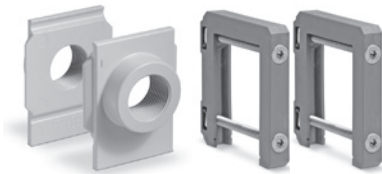

Part Number	Availability
MX2-3/8-HH	✓
MX2-1/2-HH	✓
MX2-3/4-HH	✓
MX2-3/8-JJ*	✓
MX2-1/2-JJ*	✓
MX2-3/4-JJ*	✓

Part Number	Availability
MX3-3/4-HH	✓
MX3-1-HH	✓
MX3-3/4-JJ*	✓
MX3-1-JJ*	✓

*kit with wall fixing screw

Rapid clamps kit with wall fixing brackets + flanges for Series MX

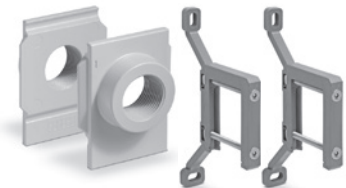

Part Number	Availability
MX2-3/8-KK	✓
MX2-1/2-KK	✓
MX2-3/4-KK	✓

Part Number	Availability
MX3-3/4-KK	✓
MX3-1-KK	✓

Block for Pressure Gauge Fixing

The kit is supplied with:
- 1 block
- 1 grain
- 2 screws
- 1 seal

New



Part Number	Availability
MX2-R26/1-P	✓
MX3-R26/1-P	✓

MX Built-in Pressure Gauge

The kit is supplied with:
- 1 pressure gauge
- 1 seal
- 2 screws

New



Part Number	Availability	Range
MX3-R30/W-P	✓	0 - 2.5 bar
MX3-R31/W-P	✓	0 - 6 bar
MX3-R32/W-P	✓	0 - 10 bar
MX3-R33/W-P	✓	0 - 12 bar

Series MC Filters

Connections: 1/4, 3/8, 1/2

Modular

With metal bowl and bayonet-type mounting

Full Data Sheet and Dimensions at <https://store.camozzi.co.uk>

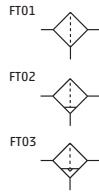



- ✓ Ex Stock
- 🔧 UK Assembly
- 📞 Please Call Sales Office

CODING EXAMPLE

MC 2 02 - F 0 0

MC	SERIES: MC	F	FILTER
2	SIZE: 1 = 1/4 2 = 3/8 - 1/2	0	FILTERING ELEMENT: 0 = 25µm (standard) 1 = 5µm
02	CONNECTIONS: 04 = 1/4 38 = 3/8 02 = 1/2	0	DRAINING OF CONDENSATE: 0 = semi-automatic manual drain (standard - only for polymer bowl) 3 = automatic drain 5 = depressuring drain, protected (only for polymer bowl) 8 = without drain with connection 1/8

Semi Auto Drain	Availability	Symbol	1/4	3/8	1/2	
25 micron	✓	FT02	MC104 F00	MC238 F00	MC202 F00	
5 micron	✓	FT02	MC104 F10	MC238 F10	MC202 F10	
Depressurisation Drain	Availability	Symbol	1/4	Automatic Drain	3/8	1/2
25 micron	✓	FT03	MC104 F04		MC238 F10	MC202 F10
5 micron	✓	FT03	MC104 F14		MC238 F13	MC202 F13

Accessories	1/4	3/8	1/2
	S6510 6-1/4	S6510 10-3/8	S6510 12-1/2
	S6520 6-1/4	S6520 10-3/8	S6520 12-1/2

Please see page 227 for additional Series MC accessories

Series MC Activated Carbon Filters

New

Connections: 1/4, 3/8 and 1/2

Modular

Metal bowl with bayonet-type mounting

Full Data Sheet and Dimensions at <https://store.camozzi.co.uk>



- ✓ Ex Stock
- 🔧 UK Assembly
- 📞 Please Call Sales Office

CODING EXAMPLE

MC 2 02 - F CA

MC	SERIES: MC	F	FILTER
2	SIZE: 1 = 1/4 2 = 3/8 - 1/2	CA	CA = Activated carbon
02	CONNECTIONS: 04 = 1/4 38 = 3/8 02 = 1/2		

Availability	Symbol	1/4	3/8	1/2
✓	FC01	MC104-FCA	MC238-FCA	MC202-FCA

Please see page 227 for Series MC Accessories

Series MC Coalescing Filters

Connections: 1/4, 3/8, 1/2

Modular

With metal bowl and bayonet-type mounting

Full Data Sheet and Dimensions at <https://store.camozzi.co.uk>

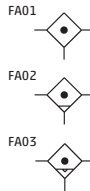

- ✓ Ex Stock
- ✎ UK Assembly
- ☎ Please Call Sales Office

CODING EXAMPLE

MC	2	02	-	F	B	0
MC	SERIES: MC			F	FILTER	
2	SIZE: 1 = 1/4 2 = 3/8 - 1/2			B	FILTERING ELEMENT: B = 0.01µm	
02	CONNECTIONS: 04 = 1/4 38 = 3/8 02 = 1/2			0	DRAINING OF CONDENSATE: 0 = manual - semi-automatic 3 = automatic (only for 3/8 and 1/2) 4 = depressurisation (only 1/4) 5 = depressurisation, protected 8 = no drain, connection 1/8, see page 249	

Coalescing Filter 0.01 Micron	Availability	Symbol	1/4	3/8	1/2
Semi Auto Drain	✓	FA02	MC104 FBO	MC238 FBO	MC202 FBO

Accessories	1/4	3/8	1/2
-------------	-----	-----	-----



S6510 6-1/4 S6510 10-3/8 S6510 12-1/2



S6520 6-1/4 S6520 10-3/8 S6520 12-1/2

Please see page 227 for additional Series MC accessories

Series MC Lubricators

Connections: 1/4, 3/8, 1/2

Modular

With metal bowl and bayonet-type mounting

Full Data Sheet and Dimensions at <https://store.camozzi.co.uk>



- ✓ Ex Stock
- ✎ UK Assembly
- ☎ Please Call Sales Office

CODING EXAMPLE

MC	2	02	-	L	00
MC	SERIES: MC			L	LUBRICATOR
1	SIZE: 1 = 1/4 2 = 3/8 - 1/2			00	DESIGN TYPE: 00 = atomized oil
02	CONNECTIONS: 04 = 1/4 38 = 3/8 02 = 1/2				

Availability	1/4	3/8	1/2
	✓	MC104 L00	MC238 L00 MC202 L00

Please see page 227 for Series MC Accessories

Series MC Pressure Regulators

Connections: 1/4, 3/8, 1/2

Modular

Full Data Sheet and Dimensions at <https://store.camozzi.co.uk>

AIR TREATMENT

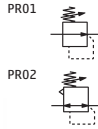

CODING EXAMPLE

MC 2 02 - R T 0 2 - VS - ■ - ●

MC	SERIES: MC	0	DESIGN TYPE: 0 = self-relieving (standard) 1 = non-relieving 5 = precise-relieving
2	SIZE: 1 = 1/4 2 = 3/8 - 1/2		
02	CONNECTIONS: 04 = 1/4 38 = 3/8 02 = 1/2	2	PRESSURE GAUGE: = without pressure gauge 1 = with pressure gauge 0-2.5, with working pressure 0-2 bar 2 = with pressure gauge 0-6, with working pressure 0-4 bar 3 = with pressure gauge 0-10, with working pressure 0.5-7 bar 4 = with pressure gauge 0-12, with working pressure 0.5 - 10 bar
R	REGULATOR		
T	OPERATING PRESSURE: 0 = 0.5 - 10 (standard) 1 = 0 - 4 2 = 0 - 2 (only 1/4) 7 = 0.5 - 7 (only 1/4) T = calibrated* B = locked*	VS	TYPE OF REGULATOR: = without by-pass valve (standard) VS = with by-pass valve (only 1/4)

** NOTE: IF THE REGULATOR IS CALIBRATED OR LOCKED, AFTER THE PORTS ADD THE INLET PRESSURE "■" AND THE OUTLET PRESSURE "●"

INLET PRESSURE:

■ = enter the SUPPLY pressure value

OUTLET PRESSURE:





● = enter the OUTLET pressure value for the LOCKED regulator or

the maximum value of the ADJUSTABLE pressure for the CALIBRATED regulator

Example of a calibrated regulator with Inlet Pressure = 6.3 bar and Outlet Pressure = 4.5 bar
Complete part number: MC104-MT03-6.3-4.5

** the pressure gauges are supplied disassembly
for size 1 pressure gauge mod. M043-P..
for size 2 pressure gauge mod.M053-P..

- ✓ Ex Stock
- 🔧 UK Assembly
- ☎ Please Call Sales Office

Self Relieving	Availability	Symbol	1/4	3/8	1/2
0.5 - 10 bar	✓	PRO2	MC104 R00	MC238 R00	MC202 R00
0 - 4 bar	✓	PRO2	MC104 R10	MC238 R10	MC202 R10
Non Relieving	Availability	Symbol	1/4	3/8	1/2
0.5 - 10 bar	✓	PRO1	MC104 R01	MC238 R01	MC202 R01
0 - 4 bar	✓	PRO1	MC104 R11	MC238 R11	MC202 R11
Accessories			1/4	3/8	1/2
			S6510 6-1/4	S6510 10-3/8	S6510 12-1/2
			S6520 6-1/4	S6520 10-3/8	S6520 12-1/2
			C238-ST/1	C238-ST/1	C238-ST/1
			M043-P12	M053-P12	M053-P12

Please see page 227 for additional Series MC accessories

Series MC Filter/Regulators

Connections: 1/4, 3/8, 1/2

Modular

Metal bowl and bayonet-type mounting Modular

Metal bowl and bayonet-type mounting

Full Data Sheet and Dimensions at <https://store.camozzi.co.uk>



CODING EXAMPLE



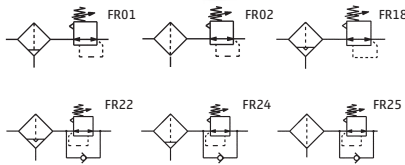

MC	2	02	-	D	0	0	2	-	4	-	VS
----	---	----	---	---	---	---	---	---	---	---	----

MC	SERIES: MC	0	DRAINING OF CONDENSATE: 0 = manual semi-automatic self-relieving (standard) 1 = manual semi-automatic, non-relieving 3 = automatic, self-relieving (only 3/8 and 1/2) 4 = depressurisation self-relieving (only 1/4) 5 = depressurisation, protected, self-relieving 8 = no drain, connection 1/8, self-relieving see page 249
2	SIZE: 1 = 1/4 2 = 3/8 - 1/2	2	PRESSURE GAUGE: = without pressure gauge 1 = with pressure gauge 0-2.5, with working pressure 0-2 bar 2 = with pressure gauge 0-6, with working pressure 0-4 bar 3 = with pressure gauge 0-10, with working pressure 0.5-7 bar 4 = with pressure gauge 0-12, with working pressure 0.5 - 10 bar
02	CONNECTIONS: 04 = 1/4 02 = 1/2 38 = 3/8	D	FILTER/REGULATOR
0	FILTERING ELEMENT: 0 = 25µm (standard) 1 = 5µm	4	OPERATING PRESSURE: = 0.5 - 10 2 = 0 - 2 (only 1/4) 4 = 0 - 4 7 = 0.5 - 7 (only 1/4)
		VS	TYPE OF REGULATOR: = without by-pass valve (standard) VS = with by-pass valve (only 1/4)



- ✓ Ex Stock
- 🔧 UK Assembly
- 📞 Please Call Sales Office

** the pressure gauges are supplied disassembly, for size 1 pressure gauges M043-P.., for size 2 pressure gauges M053-P..

Semi Auto Drain		Availability	Symbol	1/4	3/8	1/2	
Self Relieving							
25 micron	✓	FR01	MC104 D00	MC238 D00	MC202 D00		
5 micron	✓	FR01	MC104 D10	MC238 D10	MC202 D10		
Semi Auto Drain		Availability	Symbol	1/4	3/8	1/2	
Non Relieving							
25 micron	✓	FR011	MC104 D01	MC238 D01	MC202 D01		
5 micron	✓	FR011	MC104 D11	MC238 D11	MC202 D11		
Depressurisation		Availability	Symbol	1/4	Automatic Drain	3/8	1/2
25 micron	✓	FR018	MC104 D04	MC238 D03	MC202 D03		
5 micron	✓	FR018	MC104 D14	MC238 D13	MC202 D13		
Depressurisation		Availability	Symbol	1/4	3/8	1/2	
Drain Protected							
25 micron	📞	FR018	MC104 D05	MC238 D05	MC202 D05		
5 micron	📞	FR018	MC104 D15	MC238 D15	MC202 D15		
Connection 1/8		Availability	Symbol	1/4	3/8	1/2	
25 micron	📞	FR02	MC104 D08	MC238 D08	MC202 D08		
5 micron	📞	FR02	MC104 D18	MC238 D18	MC202 D18		
Accessories		Availability	Symbol	1/4	3/8	1/2	
			S6510 6-1/4	S6510 10-3/8	S6510 12-1/2		
			S6520 6-1/4	S6520 10-3/8	S6520 12-1/2		
			C238-ST/1	C238-ST/1	C238-ST/1		
			M043-P12	M053-P12	M053-P12		

Please see page 227 for additional Series MC accessories

Series MC Lockable Isolation 3/2-way Valves

Electropneumatic, pneumatic and manual version
Connections: 1/4, 3/8, 1/2
Modular

Full Data Sheet and Dimensions
at <https://store.camozzi.co.uk>

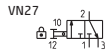

- ✓ Ex Stock
- ✎ UK Assembly
- ☎ Please Call Sales Office

CODING EXAMPLE

MC	1	04	-	V	01
MC	SERIES: MC				
2	SIZE: 1 = 1/4 2 = 3/8 - 1/2			V	3-WAY VALVE
02	CONNECTIONS: 04 = 1/4 38 = 3/8 02 = 1/2			16	DESIGN TYPE: 01 = padlock valve (manual operation)

Availability	1/4	3/8	1/2
✓	MC104 V01	MC238 V01	MC202 V01

Please see page 227 for Series MC Accessories

Series MC 3/2 Valves Pneumatically or Electropneumatically Operated

Connections: 1/4, 3/8, 1/2
Modular

Full Data Sheet and Dimensions
at <https://store.camozzi.co.uk>

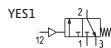
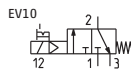

- ✓ Ex Stock
- ✎ UK Assembly
- ☎ Please Call Sales Office

CODING EXAMPLE

MC	2	02	-	V	16
MC	SERIES: MC				
2	SIZE: 1 = 1/4 2 = 3/8 - 1/2			V	3/2 VALVE
02	CONNECTIONS: 04 = 1/4 38 = 3/8 02 = 1/2			16	DESIGN TYPE: 16 = electropneumatic 36 = pneumatic

Availability	Symbol	1/4	3/8	1/2
Electropneumatic ✓	EV10	MC104 V16	MC238 V16	MC202 V16
Pneumatic ✓	YES1	MC104 V36	MC238 V36	MC202 V36

Accessories	1/4	3/8	1/2
-------------	-----	-----	-----



S6510 6-1/4 **S6510 10-3/8** **S6510 12-1/2**



S6520 6-1/4 **S6520 10-3/8** **S6520 12-1/2**



Note: Required for
Electro-Pneumatic
Control Only

U7* **U7*** **U7***

Please see page 133 for voltage options

Series MC Soft Start Valves

Connections: 1/4, 3/8, 1/2
Modular

Full Data Sheet and Dimensions
at <https://store.camozzi.co.uk>



CODING EXAMPLE

MC	2	02	-	AV
-----------	----------	-----------	----------	-----------

MC	SERIES: MC		
2	SIZE: 1 = 1/4 2 = 3/8 - 1/2	AV	SOFT START VALVE
02	CONNECTIONS: 04 = 1/4 38 = 3/8 02 = 1/2		

- ✓ Ex Stock
- ✂ UK Assembly
- 📞 Please Call Sales Office

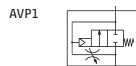

Availability	1/4	3/8	1/2
✓	MC104 AV	MC238 AV	MC202 AV
✓			
Accessories	1/4	3/8	1/2
	S6510 6-1/4	S6510 10-3/8	S6510 12-1/2
	S6520 6-1/4	S6520 10-3/8	S6520 12-1/2

Please see page 227 for additional Series MC accessories

Series MC Take-off Blocks

Connections: 1/4 and 1/2

Full Data Sheet and Dimensions
at <https://store.camozzi.co.uk>



CODING EXAMPLE

MC	2	-	B	-	VNR
-----------	----------	----------	----------	----------	------------

MC	SERIES: MC		
2	SIZE: 1 = 1/4 2 = 1/2	VNR	VERSION: = standard VNR = with non return valve
B	TAKE OFF BLOCK		

- ✓ Ex Stock
- ✂ UK Assembly
- 📞 Please Call Sales Office

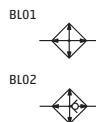

Availability	Symbol	1/4	1/2
✓	BL01	MC1-B	MC2-B
✓	BL02	MC1-B-VNR	MC2-B-VNR
Accessories		1/4	1/2
		S6510 6-1/4	S6510 12-1/2
		S6520 6-1/4	S6520 12-1/2

Please see page 227 for additional Series MC accessories

Series MC FRL Assembled

Connections: 1/4, 3/8, 1/2

The FRL Series MC in the assembled versions are easier to order (one single code) and to mount.

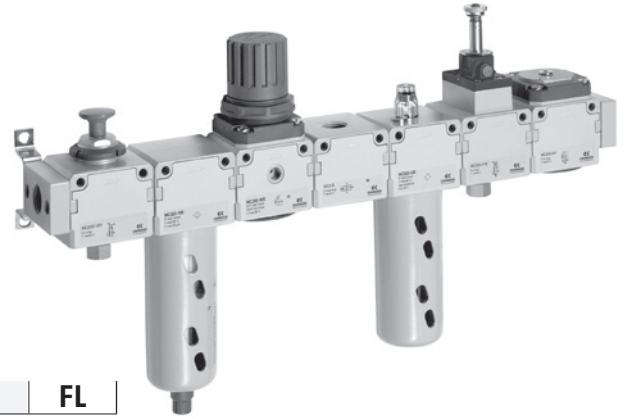

CODING EXAMPLE

MC	2	02	-	C	-	5	-	FL
----	---	----	---	---	---	---	---	----

MC	SERIES: MC	
2	SIZE: 1 = 1/4 2 = 3/8 - 1/2	C ASSEMBLY GROUP: C = D + L E = V01 + D + L FRL = F + R + L GN = D + L + V16 + AV HNA = V01 + D + L + V16 + AV + PRESS N.A. HNC = V01 + D + L + V16 + AV + PRESS N.C. N = V01 + D PN = D + V16 + AV QN = V01 + D + V16 + AV TN = V01 + D + L + V16 + AV ZNA = V01 + D + V16 + AV + PRESS N.A. ZNC = V01 + D + V16 + AV + PRESS N.C.
02	CONNECTIONS: 04 = 1/4 38 = 3/8 02 = 1/2	
		5 FILTERING ELEMENT: 5 = 5 µm (upon request) 25 = 25 µm (standard)
		FL VERSION: FL = with terminal flanges

ASSEMBLY GROUP KEY

D	Filter-regulator 0-10 bar semi-automatic manual drain filtering element 25µm	F	Filter 25 µm
V01	Valve 3/2 way manually operated	R	Regulator 0 - 10 bar
V16	Valve 3/2 way electropneumatically operated	AV	Soft start valve
L	Lubricator	PRESS	Pressure switches (defined if N.C. or N.A.)
		F13	Filter 5µm or 25µm with automatic drain

Assembly group C (see above for descriptions)

Including gauge and bracket

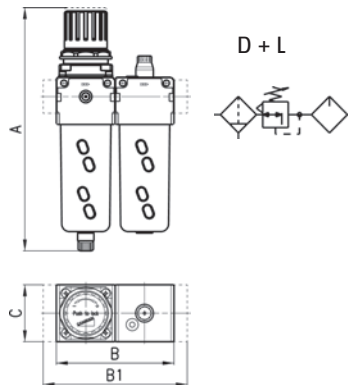

- ✓ Ex Stock
- 🔧 UK Assembly
- ☎ Please Call Sales Office

DIMENSIONS						
Part Number	Availability	A	B	B1	C	Connection
MC104-C-25	🔧	193.5	90	-	45	1/4
MC104-C-25-FL	🔧	193.5	-	114	45	1/4
MC238-C-25	🔧	256.5	124	-	60	3/8
MC238-C-25-FL	🔧	256.5	-	152	60	3/8
MC202-C-25	🔧	256.5	124	-	60	1/2
MC202-C-25-FL	🔧	256.5	-	152	60	1/2

Please see page 227 for Series MC Accessories

Assembly group E (see above for descriptions)

Including gauge and bracket

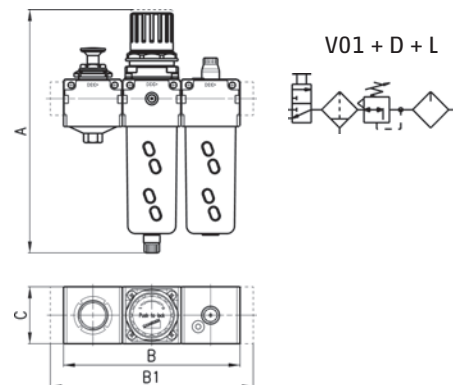

- ✓ Ex Stock
- 🔧 UK Assembly
- ☎ Please Call Sales Office

DIMENSIONS						
Part Number	Availability	A	B	B1	C	Connection
MC104-E-25	🔧	193.5	135	-	45	1/4
MC104-E-25-FL	🔧	193.5	-	159	45	1/4
MC238-E-25	🔧	256.5	186	-	60	3/8
MC238-E-25-FL	🔧	256.5	-	214	60	3/8
MC202-E-25	🔧	256.5	186	-	60	1/2
MC202-E-25-FL	🔧	256.5	-	214	60	1/2

Assembly group FRL (see page 223 for descriptions)

Including gauge and bracket

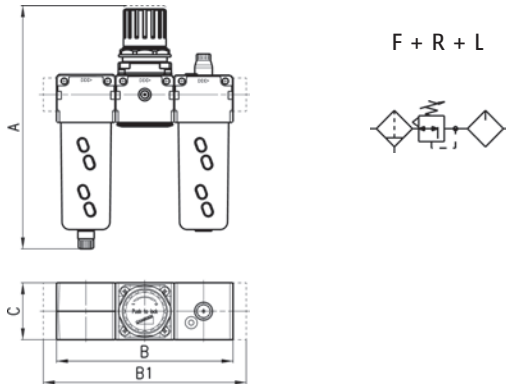

- ✓ Ex Stock
- ✎ UK Assembly
- ☎ Please Call Sales Office

DIMENSIONS						
Part Number	Availability	A	B	B1	C	Connection
MC104-FRL-25	✎	193.5	135	-	45	1/4
MC104-FRL-25-FL	✎	193.5	-	159	45	1/4
MC238-FRL-25	✎	256.5	186	-	60	3/8
MC238-FRL-25-FL	✎	256.5	-	214	60	3/8
MC202-FRL-25	✎	256.5	186	-	60	1/2
MC202-FRL-25-FL	✎	256.5	-	214	60	1/2

Assembly group GN (see page 223 for descriptions)

Including gauge and bracket

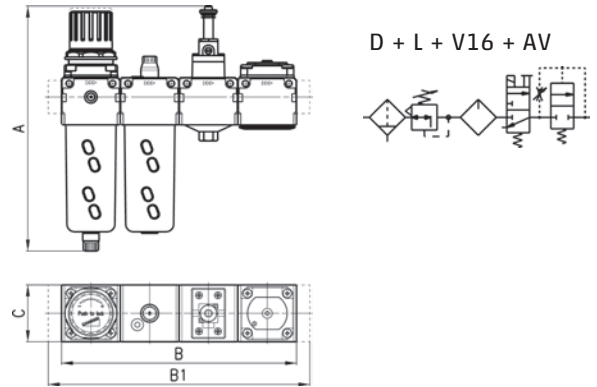

- ✓ Ex Stock
- ✎ UK Assembly
- ☎ Please Call Sales Office

DIMENSIONS						
Part Number	Availability	A	B	B1	C	Connection
MC104-PN-25	✎	208	135	-	45	1/4
MC104-PN-25-FL	✎	208	-	159	45	1/4
MC238-PN-25	✎	259	186	-	60	3/8
MC238-PN-25-FL	✎	259	-	214	60	3/8
MC202-PN-25	✎	259	186	-	60	1/2
MC202-PN-25-FL	✎	259	-	214	60	1/2

Assembly group HN... (see page 223 for descriptions)

Including gauge and bracket

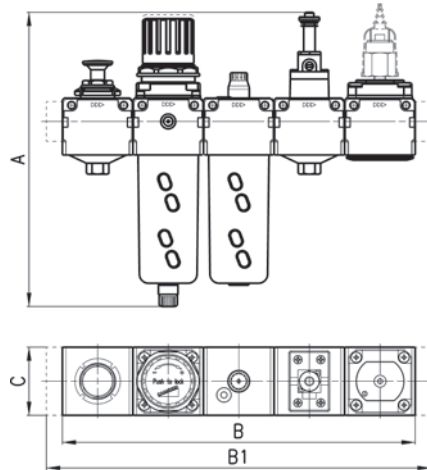

- ✓ Ex Stock
- ✎ UK Assembly
- ☎ Please Call Sales Office

DIMENSIONS						
Part Number	Availability	A	B	B1	C	Connection
MC104-QN-25	✎	208	180	-	45	1/4
MC104-QN-25-FL	✎	208	-	204	45	1/4
MC238-QN-25	✎	259	248	-	60	3/8
MC238-QN-25-FL	✎	259	-	276	60	3/8
MC202-QN-25	✎	259	248	-	60	1/2
MC202-QN-225-FL	✎	259	-	276	60	1/2

Please see page 227 for Series MC Accessories

V01 + D + L + V16 + AV + PRESS N.A.

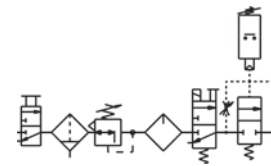

HNA
Pressure switch normally open

V01 + D + L + V16 + AV + PRESS N.C.

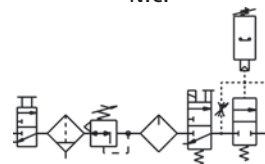

HNC
Pressure switch normally closed

Assembly group N (see page 223 for descriptions)

Including gauge and bracket

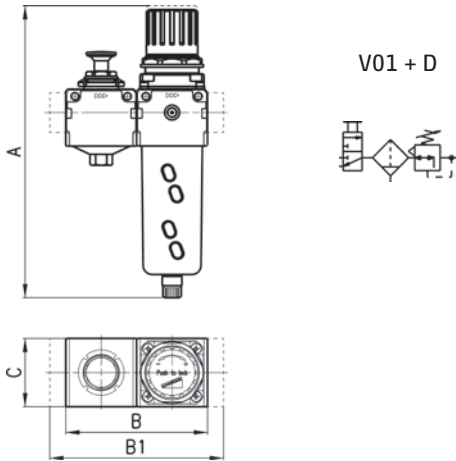

- ✓ Ex Stock
- ✎ UK Assembly
- ☎ Please Call Sales Office

DIMENSIONS						
Part Number	Availability	A	B	B1	C	Connection
MC104-N-25	✎	193.5	90	-	45	1/4
MC104-N-25-FL	✎	193.5	-	114	45	1/4
MC238-N-25	✎	256.5	124	-	60	3/8
MC238-N-25-FL	✎	256.5	-	152	60	3/8
MC202-N-25	✎	256.5	124	-	60	1/2
MC202-N-25-FL	✎	256.5	-	152	60	1/2

Assembly group PN

(see page 223 for descriptions)

Including gauge and bracket

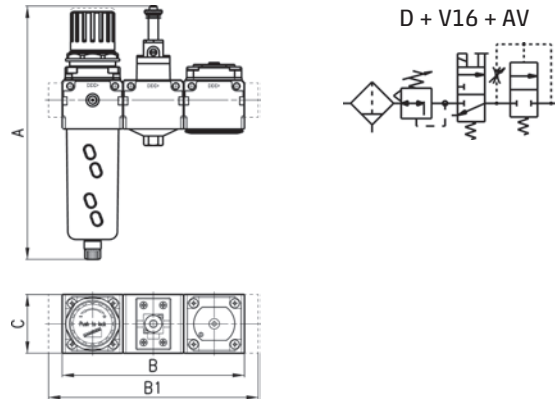

- ✓ Ex Stock
- ✎ UK Assembly
- ☎ Please Call Sales Office

DIMENSIONS						
Part Number	Availability	A	B	B1	C	Connection
MC104-PN-25	✎	208	135	-	45	1/4
MC104-PN-25-FL	✎	208	-	159	45	1/4
MC238-PN-25	✎	259	186	-	60	3/8
MC238-PN-25-FL	✎	259	-	214	60	3/8
MC202-PN-25	✎	259	186	-	60	1/2
MC202-PN-25-FL	✎	259	-	214	60	1/2

Assembly group QN

(see page 223 for descriptions)

Including gauge and bracket

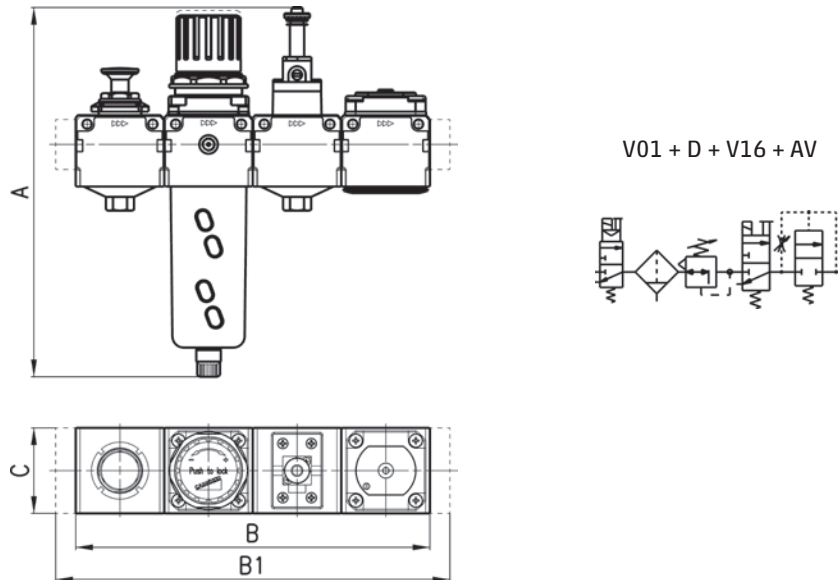

- ✓ Ex Stock
- ✎ UK Assembly
- ☎ Please Call Sales Office

DIMENSIONS						
Part Number	Availability	A	B	B1	C	Connection
MC104-QN-25	✎	208	180	-	45	1/4
MC104-QN-25-FL	✎	208	-	204	45	1/4
MC238-QN-25	✎	259	248	-	60	3/8
MC238-QN-25-FL	✎	259	-	276	60	3/8
MC202-QN-25	✎	259	248	-	60	1/2
MC202-QN-225-FL	✎	259	-	276	60	1/2

Please see page 227 for Series MC Accessories

Series MC Assembly Manifold Regulators

Regulators for manifold assembly

Connections: 1/4

Modular

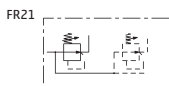
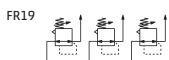

CODING EXAMPLE

MC	1	04	-	M	T	0	2	-	■	-	●
MC	SERIES: MC			0 CONSTRUCTION: 0 = self-relieving (standard) 1 = non-relieving 5 = precise relieving							
1	SIZE: 1 = 1/4			2 PRESSURE GAUGE: = without pressure gauge 1 = with pressure gauge 0-2.5, with working pressure 0-2 bar 2 = with pressure gauge 0-6, with working pressure 0-4 bar 3 = with pressure gauge 0-10, with working pressure 0.5-7 bar 4 = with pressure gauge 0-12, with working pressure 0.5 - 10 bar							
04	CONNECTIONS: 04 = 1/4			M MANIFOLD REGULATOR							
T	OPERATING PRESSURE: 0 = 0.5 - 10 (standard) 1 = 0 - 4 2 = 0.5 - 2 7 = 0.5 - 7										

** NOTE: IF THE REGULATOR IS CALIBRATED OR LOCKED, AFTER THE PORTS ADD THE INLET PRESSURE "■" AND THE OUTLET PRESSURE "●"

INLET PRESSURE:
■ = enter the SUPPLY pressure value
OUTLET PRESSURE:
● = enter the OUTLET pressure value for the LOCKED regulator or the maximum value of the ADJUSTABLE pressure for the CALIBRATED regulator

Example of a calibrated regulator with Inlet Pressure = 6.3 bar and Outlet Pressure = 4.5 bar
Complete part number: MC104-MT03-6.3-4.5

** the pressure gauges are supplied disassembly for size 1 pressure gauge mod. M043-P.. for size 2 pressure gauge mod.M053-P..

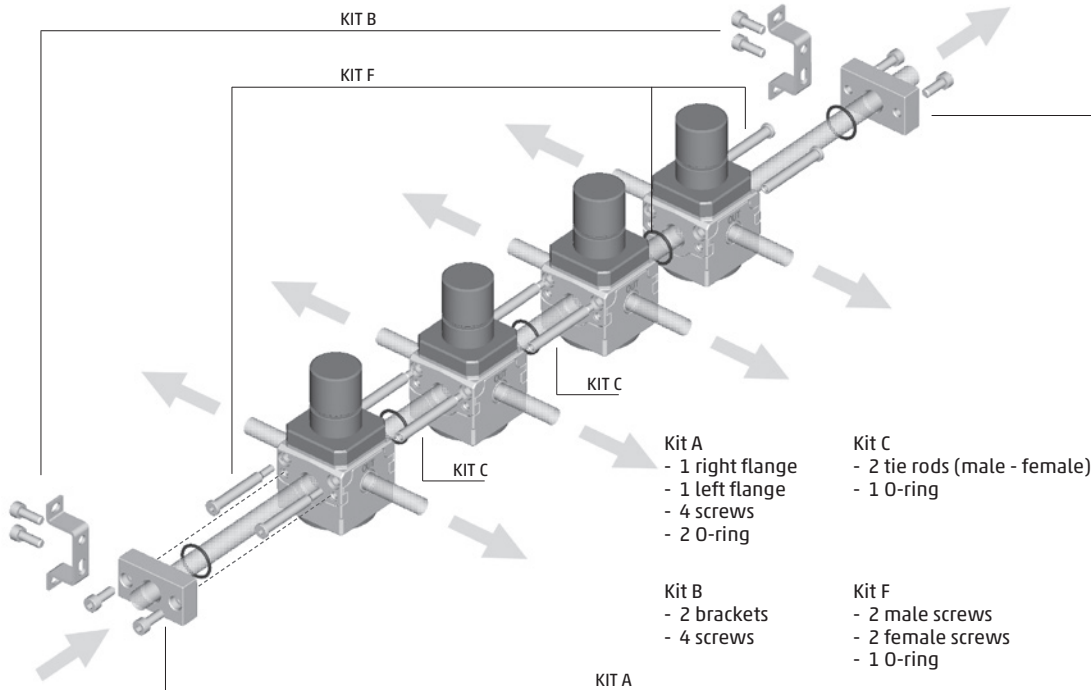

- ✓ Ex Stock
- ✂ UK Assembly
- ⌚ Please Call Sales Office

Manifold Regulator	Availability	Symbol	Kit A	Kit B	Kit C	Kit F
MC104 M00	✓	FR19	MC104-FL	MC104-ST	MC1-TMF	MC1-VMF
MC104 M10	⌚	FR19	MC104-FL	MC104-ST	MC1-TMF	MC1-VMF
MC104 M01	⌚	FR21	MC104-FL	MC104-ST	MC1-TMF	MC1-VMF
MC104 M11	⌚	FR21	MC104-FL	MC104-ST	MC1-TMF	MC1-VMF

Assembly without terminal flanges



Body	Kit
H + H	1 Kit "F"
H + H + H	1 Kit "F" + 1 Kit "C"
H + H + H + H	1 Kit "F" + 2 Kit "C"
H + H + H + H + H	1 Kit "F" + 3 Kit "C"

Please see page 238 for Series MC Accessories

Assembly with terminal flanges

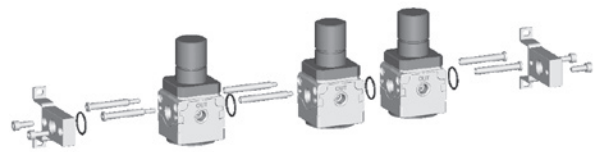

Body	Kit
H + H	1 Kit "A" + 1 Kit "F"
H + H + H	1 Kit "A" + 1 Kit "F" + 1 Kit "C"
H + H + H + H	1 Kit "A" + 1 Kit "F" + 2 Kit "C"
H + H + H + H + H	1 Kit "A" + 1 Kit "F" + 3 Kit "C"

Series MC Accessories for FRL

- ✓ Ex Stock
- ✎ UK Assembly
- ⊗ Please Call Sales Office

Terminal Flanges (pair).
Series MC
(kit A)
Complete with: N° 4 screws,
N° 2 O-Ring



Part Number	Availability	Connection
MC104-FL	✓	1/4
MC238-FL	✓	3/8
MC202-FL	✓	1/2

2 Mounting Brackets.
Series MC
(kit B)
For 1/4, 3/8 and 1/2.
Complete with: N° 4 screws M5



Part Number	Availability
MC104-ST	✓

Tie-rod for assembling Series MC
(kit C)
Male and female tie-rods
complete with:
N° 2 tie-rods, N° 1 O-Ring



Part Number	Availability	Connection
MC1-TMF	✓	1/4
MC2-TMF	✓	3/8-1/2

Tie-rod for assembling Series MC
(kit D)
Female tie-rods
complete with:
N° 2 tie-rods



Part Number	Availability	Connection
MC1-TFF	✓	1/4
MC2-TFF	✓	3/8-1/2

Screw for assembling Series MC
(kit E)
Complete with:
N° 2 screws,
N° 1 O-Ring



Part Number	Availability	Connection
MC1-VM	✓	1/4
MC2-VM	✓	3/8-1/2

Screw for assembling Series MC (kit F)
Complete with:
N° 2 male screws,
N° 2 female screws,
N° 1 O-Ring



Part Number	Availability	Connection
MC1-VMF	✓	1/4
MC2-VMF	✓	3/8-1/2

Mounting Bracket. Series MC-M-N
R-D (1/8 - 1/4)

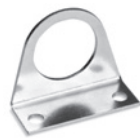

Part Number	Availability
C114-ST	✓

Mounting Bracket. Series MC-M-N
R-D (1/8 - 1/4)



Part Number	Availability
C114-ST/1	✓

Mounting Bracket. Series MC-M-N
R-D (1/8 - 1/4)



Part Number	Availability
C114-ST/2	✓

Mounting Bracket C238-ST/1
for MC238 and MC202
The Kit is supplied with 1 bracket,
2 screws M5X65
Materials: zinc-plated steel
bracket and screws



Part Number	Availability
C238-ST/1	✓

Fixing Bracket MX2-S
for regulators MC238 and MC202
The Kit is supplied with
1 zinc-plated steel bracket



Part Number	Availability
MX2-S	✓

Screws (kit G) to assemble 2 Bodies
Type 'M'



Part Number	Availability
MC1-VMD	✓
MC2-VMD	✓

Series MD Filters

Connections with interchangeable cartridges: threaded (1/8, 1/4, 3/8) or integrated with super-rapid fitting for tube with Ø 6, 8 and 10mm

Modular assembly

Bowl with technopolymer cover and bayonet-type mounting

Full Data Sheet and Dimensions at <https://store.camozzi.co.uk>



- ✓ Ex Stock
- 🇬🇧 UK Assembly
- 📞 Please Call Sales office

CODING EXAMPLE

MD	1	-	F	0	0	0	-	1/8
----	---	---	---	---	---	---	---	-----

MD	SERIES: MD	0	DRAINING OF CONDENSATE: 0 = semi-automatic manual drain (standard) 5 = depressuring drain, protected 8 = no drain with connection 1/8 see page 249
1	SIZE: 1 = 42mm		
F	FILTER	0	VISUAL INDICATOR: 0 = Without indicator 1 = With indicator
0	FILTERING ELEMENT: 0 = 25µm (standard) 1 = 5µm	1/8	CONNECTIONS (IN/OUT*): = no connection 1/8, 1/4, 3/8, 6, 8, 10

ACCESSORIES

Part Number	Availability	Symbol	Connection
Without Indicator			
MD1-F000	✓	FT02	-
MD1-F000-1/8	✓	FT02	1/8
MD1-F000-1/4	✓	FT02	1/4
MD1-F000-3/8	✓	FT02	3/8
MD1-F000-6	✓	FT02	Ø6
MD1-F000-8	✓	FT02	Ø8
MD1-F000-10	✓	FT02	Ø10

Part Number	Availability	Symbol	Connection
With Indicator			
MD1-F001	✓	FT02	-
MD1-F001-1/8	✓	FT02	1/8
MD1-F001-1/4	✓	FT02	1/4
MD1-F001-3/8	✓	FT02	3/8
MD1-F001-6	✓	FT02	Ø6
MD1-F001-8	✓	FT02	Ø8
MD1-F001-10	✓	FT02	Ø10

Mounting Bracket



MD1-ST/1
Please see page 238 for more Series MD Accessories

*If the input and output connections are different, please add both values when ordering. Example: MD1-F000-1/8-1/4
N.B. 5 Micron, depressurisation drain and connection 1/8 also available on request. See coding table above.

Series MD Activated Carbon Filters

Connections with interchangeable cartridges: threaded (1/8, 1/4, 3/8) or integrated with super-rapid fitting for tube with Ø 6, 8 and 10mm

Modular assembly Bowl with technopolymer cover and bayonet-type mounting

Full Data Sheet and Dimensions at <https://store.camozzi.co.uk>



- ✓ Ex Stock
- 🇬🇧 UK Assembly
- 📞 Please Call Sales Office

CODING EXAMPLE

MD	1	-	FCA	0	-	1/8
----	---	---	-----	---	---	-----

MD	Series: MD	0	VISUAL INDICATOR: 0 = Without indicator 1 = With indicator
1	SIZE: 1 = 42mm		
FCA	ACTIVATED CARBON FILTER	1/8	CONNECTIONS (IN/OUT*): = no connection 1/8, 1/4, 3/8, 6, 8, 10

ACCESSORIES

Part Number	Availability	Connection
Without Indicator		
MD1-FCA0	✓	-
MD1-FCA0-1/8	✓	1/8
MD1-FCA0-1/4	✓	1/4
MD1-FCA0-3/8	✓	3/8
MD1-FCA0-6	✓	Ø6
MD1-FCA0-8	✓	Ø8
MD1-FCA0-10	✓	Ø10

Part Number	Availability	Connection
With Indicator		
MD1-FCA1	✓	-
MD1-FCA1-1/8	✓	1/8
MD1-FCA1-1/4	✓	1/4
MD1-FCA1-3/8	✓	3/8
MD1-FCA1-6	✓	Ø6
MD1-FCA1-8	✓	Ø8
MD1-FCA1-10	✓	Ø10

Mounting Bracket



MD1-ST/1
Please see page 238 for more Series MD Accessories

*If the input and output connections are different, please add both values when ordering. Example: MD1-FCA0-1/8-1/4

Series MD Coalescing Filters

Connections with interchangeable cartridges: threaded (1/8, 1/4, 3/8) or integrated with super-rapid fitting for tube with Ø 6, 8 and 10mm

Modular assembly

Bowl with technopolymer cover and bayonet-type mounting

Full Data Sheet and Dimensions at <https://store.camozzi.co.uk>

AIR TREATMENT

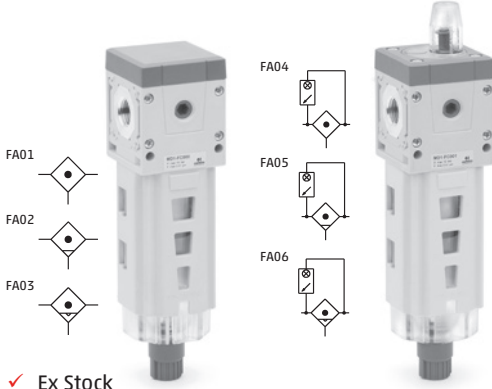

- ✓ Ex Stock
- ✎ UK Assembly
- ☎ Please Call Sales Office

CODING EXAMPLE

MD	1	-	FC	0	0	0	-	1/8
----	---	---	----	---	---	---	---	-----

MD	SERIES: MD	0	DRAINING OF CONDENSATE: 0 = semi-automatic manual drain (standard) 5 = depressuring drain, protected 8 = no drain with connection 1/8 see page 249
1	SIZE: 1 = 42mm	0	VISUAL INDICATOR: 0 = Without indicator 1 = With indicator
FC	COALESCING FILTER	0	CONNECTIONS (IN/OUT*): = no connection 1/8, 1/4, 3/8, 6, 8, 10
0	FILTERING ELEMENT: 0 = 0.01µm (standard) 1 = 1µm	1/8	

ACCESSORIES

Part Number	Availability	Symbol	Connection
Without Indicator			
MD1-FC000	✓	FA02	-
MD1-FC000-1/8	✓	FA02	1/8
MD1-FC000-1/4	✓	FA02	1/4
MD1-FC000-3/8	✓	FA02	3/8
MD1-FC000-6	✓	FA02	Ø6
MD1-FC000-8	✓	FA02	Ø8
MD1-FC000-10	✓	FA02	Ø10

Part Number	Availability	Symbol	Connection
With Indicator			
MD1-FC001	✓	FA02	-
MD1-FC001-1/8	✓	FA02	1/8
MD1-FC001-1/4	✓	FA02	1/4
MD1-FC001-3/8	✓	FA02	3/8
MD1-FC001-6	✓	FA02	Ø6
MD1-FC001-8	✓	FA02	Ø8
MD1-FC001-10	✓	FA02	Ø10

Mounting Bracket



MD1-ST/1

Please see page 238 for more Series MD Accessories

*If the input and output connections are different, please add both values when ordering. Example: MD1-F000-1/8-1/4 N.B. 5 Micron, depressurisation drain and connection 1/8 also available on request. See coding table above.

Series MD Lubricators

Connections with interchangeable cartridges: threaded (1/8, 1/4, 3/8) or integrated with super-rapid fitting for tube with Ø 6, 8 and 10mm

Modular assembly

Bowl with technopolymer cover and bayonet-type mounting

Full Data Sheet and Dimensions at <https://store.camozzi.co.uk>

Note: Lubrication Oil also available



- ✓ Ex Stock
- ✎ UK Assembly
- ☎ Please Call Sales Office

CODING EXAMPLE

MD	1	-	L	00	-	1/8
----	---	---	---	----	---	-----

MD	SERIES: MD	00	DESIGN TYPE: 00 = atomized oil with refill valve 01 = atomized oil without refill valve
1	SIZE: 1 = 42mm	1/8	CONNECTIONS (IN/OUT*): = no connection 1/8, 1/4, 3/8, 6, 8, 10
L	LUBRICATOR		

Part Number	Availability	Connection
MD1-L00	✓	-
MD1-L00-1/8	✓	1/8
MD1-L00-1/4	✓	1/4
MD1-L00-3/8	✓	3/8
MD1-L00-6	✓	Ø6
MD1-L00-8	✓	Ø8
MD1-L00-10	✓	Ø10

*If the input and output connections are different, please add both values when ordering. Example: MD1-L00-1/8-1/4

Series MD Pressure Regulators

Connections with interchangeable cartridges: threaded (1/8, 1/4, 3/8) or integrated with super-rapid fitting for tube with Ø 6, 8 and 10mm

Versions: single, combined with other functions, Manifold

Full Data Sheet and Dimensions at <https://store.camozzi.co.uk>

CODING EXAMPLE

MD 1 - R T 0 0 - 1/4 - ■ - ●

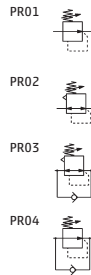

MD SERIES: MD	0 DESIGN TYPE: 0 = self-relieving 1 = non-relieving 2 = relieving high relief flow 3 = non-relieving high relief flow
1 SIZE: 1 = 42mm	0 PRESSURE GAUGE: 0 = without pressure gauge (1/8 Connection)
R R = pressure regulator M = manifold pressure regulator	1/4 CONNECTIONS (IN/OUT*): = no connection 1/8, 1/4, 3/8, 6, 8, 10
T OPERATING PRESSURE: 0 = 0.5 - 10 bar (standard) 2 = 0 - 2 bar 4 = 0 - 4 bar 7 = 0.5 - 7 bar T = calibrated** B = locked**	

**NB: IF THE REGULATOR IS CALIBRATED OR LOCKED, AFTER THE PORTS ADD THE INLET PRESSURE "■" AND THE OUTLET PRESSURE "●"

INLET PRESSURE:

■ = enter the SUPPLY pressure value

OUTLET PRESSURE:

● = enter the OUTLET pressure value for the LOCKED regulator or the maximum value of the ADJUSTABLE pressure for the CALIBRATED regulator

Example of a calibrated regulator with Inlet Pressure = 6.3 bar and Outlet Pressure = 4.5 bar
Complete Part Number: MD1-RT00-1/4-6.3-4.5

- ✓ Ex Stock
- 🇬🇧 UK Assembly
- ☎ Please Call Sales Office

Availability	Symbol	No Connection	1/8	1/4	3/8	
Self Relieving						
0.5 - 10 bar	✓	PR02 MD1-R000	MD1-R000-1/8	MD1-R000-1/4	MD1-R000-3/8	
0 - 2 bar	✓	PR02 MD1-R200	MD1-R200-1/8	MD1-R200-1/4	MD1-R200-3/8	
0 - 4 bar	✓	PR02 MD1-R400	MD1-R400-1/8	MD1-R400-1/4	MD1-R400-3/8	
0 - 7 bar	✓	PR02 MD1-R700	MD1-R700-1/8	MD1-R700-1/4	MD1-R700-3/8	
			6	8	10	
0.5 - 10 bar	✓	PR02 MD1-R000-6	MD1-R000-8	MD1-R000-10		
0 - 2 bar	✓	PR02 MD1-R200-6	MD1-R200-8	MD1-R200-10		
0 - 4 bar	✓	PR02 MD1-R400-6	MD1-R400-8	MD1-R400-10		
0 - 7 bar	✓	PR02 MD1-R700-6	MD1-R700-8	MD1-R700-10		
			No Connection	1/8	1/4	3/8
Non-Relieving						
0.5 - 10 bar	✓	PR01 MD1-R010	MD1-R010-1/8	MD1-R010-1/4	MD1-R010-3/8	
0 - 2 bar	✓	PR01 MD1-R210	MD1-R210-1/8	MD1-R210-1/4	MD1-R210-3/8	
0 - 4 bar	✓	PR01 MD1-R410	MD1-R410-1/8	MD1-R410-1/4	MD1-R410-3/8	
0 - 7 bar	✓	PR01 MD1-R710	MD1-R710-1/8	MD1-R710-1/4	MD1-R710-3/8	
			6	8	10	
0.5 - 10 bar	✓	PR01 MD1-R010-6	MD1-R010-8	MD1-R010-10		
0 - 2 bar	✓	PR01 MD1-R210-6	MD1-R210-8	MD1-R210-10		
0 - 4 bar	✓	PR01 MD1-R410-6	MD1-R410-8	MD1-R410-10		
0 - 7 bar	✓	PR01 MD1-R710-6	MD1-R710-8	MD1-R710-10		

ACCESSORIES

Mounting Bracket	Pressure Gauges
------------------	-----------------



MD1-ST/1 M043-P12
Please see page 238 for more Series MD Accessories



MD1-ST/1 M043-P12
Please see page 238 for more Series MD Accessories

*If the input and output connections are different, please add both values when ordering. Example: MD1-R000-1/8-1/4

Series MD Manifold Pressure Regulators

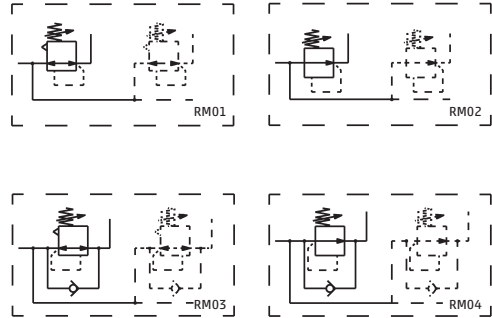

- ✓ Ex Stock
- ✦ UK Assembly
- ☎ Please Call Sales Office

Availability	Symbol	No Connection	1/8	1/4	3/8	
Self Relieving						
0.5 - 10 bar	✓	RM01	MD1-M000	MD1-M000-1/8	MD1-M000-1/4	MD1-M000-3/8
0 - 2 bar	✓	RM01	MD1-M200	MD1-M200-1/8	MD1-M200-1/4	MD1-M200-3/8
0 - 4 bar	✓	RM01	MD1-M400	MD1-M400-1/8	MD1-M400-1/4	MD1-M400-3/8
0 - 7 bar	✓	RM01	MD1-M700	MD1-M700-1/8	MD1-M700-1/4	MD1-M700-3/8
			6	8	10	
0.5 - 10 bar	✓	RM01	MD1-M000-6	MD1-M000-8	MD1-M000-10	
0 - 2 bar	✓	RM01	MD1-M200-6	MD1-M200-8	MD1-M200-10	
0 - 4 bar	✓	RM01	MD1-M400-6	MD1-M400-8	MD1-M400-10	
0 - 7 bar	✓	RM01	MD1-M700-6	MD1-M700-8	MD1-M700-10	
Non-Relieving						
			No Connection	1/8	1/4	3/8
0.5 - 10 bar	✓	RM02	MD1-M010	MD1-M010-1/8	MD1-M010-1/4	MD1-M010-3/8
0 - 2 bar	✓	RM02	MD1-M210	MD1-M210-1/8	MD1-M210-1/4	MD1-M210-3/8
0 - 4 bar	✓	RM02	MD1-M410	MD1-M410-1/8	MD1-M410-1/4	MD1-M410-3/8
0 - 7 bar	✓	RM02	MD1-M710	MD1-M710-1/8	MD1-M710-1/4	MD1-M710-3/8
			6	8	10	
0.5 - 10 bar	✓	RM02	MD1-M010-6	MD1-M010-8	MD1-M010-10	
0 - 2 bar	✓	RM02	MD1-M210-6	MD1-M210-8	MD1-M210-10	
0 - 4 bar	✓	RM02	MD1-M410-6	MD1-M410-8	MD1-M410-10	
0 - 7 bar	✓	RM02	MD1-M710-6	MD1-M710-8	MD1-M710-10	

ACCESSORIES

Mounting Bracket Pressure Gauges



MD1-ST/1 M043-P12
Please see page 238 for more Series MD Accessories



MD1-ST/1 M043-P12
Please see page 238 for more Series MD Accessories

Series MD Filter/Regulators

Connections with interchangeable cartridges: threaded (1/8, 1/4, 3/8) or integrated with super-rapid fitting for tube with Ø 6, 8 and 10mm

Modular assembly

Bowl with technopolymer cover and bayonet-type mounting.

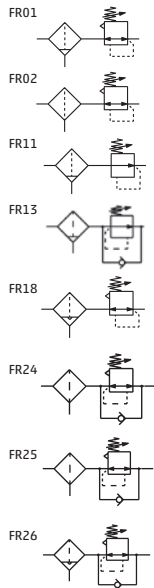

CODING EXAMPLE

MD 1 - FR 0 0 0 0 - 1/8

MD SERIES: MD	0 DRAINING OF CONDENSATE: 0 = semi-automatic manual drain (standard) 5 = depressuring drain, protected 8 = no drain with connection 1/8
1 SIZE: 1 = 42mm	0 OPERATING PRESSURE: 0 = 0.5 - 10 bar (standard) 2 = 0 - 2 bar 4 = 0 - 4 bar 7 = 0.5 - 7 bar
FR FILTER REGULATOR	0 PRESSURE GAUGE: 0 = without pressure gauge (1/8 Connection)
0 FILTERING ELEMENT WITH DESIGN TYPE: 0 = 25µm with relieving (standard) 1 = 5µm with relieving 2 = 25µm without relieving 3 = 5µm without relieving 4 = 25µm with relieving version VS 5 = 5µm with relieving version VS 6 = 25µm without relieving version VS (for semiautomatic-manual drain only) 7 = 5µm without relieving version VS (for semiautomatic-manual drain only)	1/8 CONNECTIONS (IN/OUT*): = no connection 1/8, 1/4, 3/8, 6, 8, 10

- ✓ Ex Stock
- ✎ UK Assembly
- ☎ Please Call Sales Office

ACCESSORIES

Availability Symbol	No Connection	1/8	1/4	3/8
Semi Auto Drain - Self Relieving				
0.5 - 10 bar ✓	FR01 MD1-FR0000	MD1-FR0000-1/8	MD1-FR0000-1/4	MD1-FR0000-3/8
0 - 2 bar ✓	FR01 MD1-FR0020	MD1-FR0020-1/8	MD1-FR0020-1/4	MD1-FR0020-3/8
0 - 4 bar ✓	FR01 MD1-FR0040	MD1-FR0040-1/8	MD1-FR0040-1/4	MD1-FR0040-3/8
0 - 7 bar ✓	FR01 MD1-FR0070	MD1-FR0070-1/8	MD1-FR0070-1/4	MD1-FR0070-3/8
		6	8	10
0.5 - 10 bar ✓	FR01 MD1-FR0000-6	MD1-FR0000-8	MD1-FR0000-10	
0 - 2 bar ✓	FR01 MD1-FR0020-6	MD1-FR0020-8	MD1-FR0020-10	
0 - 4 bar ✓	FR01 MD1-FR0040-6	MD1-FR0040-8	MD1-FR0040-10	
0 - 7 bar ✓	FR01 MD1-FR0070-6	MD1-FR0070-8	MD1-FR0070-10	
Semi Auto Drain - Non Relieving				
	No Connection	1/8	1/4	3/8
0.5 - 10 bar ✓	FR11 MD1-FR2000	MD1-FR2000-1/8	MD1-FR2000-1/4	MD1-FR2000-3/8
0 - 2 bar ✓	FR11 MD1-FR2020	MD1-FR2020-1/8	MD1-FR2020-1/4	MD1-FR2020-3/8
0 - 4 bar ✓	FR11 MD1-FR2040	MD1-FR2040-1/8	MD1-FR2040-1/4	MD1-FR2040-3/8
0 - 7 bar ✓	FR11 MD1-FR2070	MD1-FR2070-1/8	MD1-FR2070-1/4	MD1-FR2070-3/8
		6	8	10
0.5 - 10 bar ✓	FR11 MD1-FR2000-6	MD1-FR2000-8	MD1-FR2000-10	
0 - 2 bar ✓	FR11 MD1-FR2020-6	MD1-FR2020-8	MD1-FR2020-10	
0 - 4 bar ✓	FR11 MD1-FR2040-6	MD1-FR2040-8	MD1-FR2040-10	
0 - 7 bar ✓	FR11 MD1-FR2070-6	MD1-FR2070-8	MD1-FR2070-10	

Mounting Bracket Pressure Gauges



MD1-ST/1 M043-P12
Please see page 238 for more Series MD Accessories



MD1-ST/1 M043-P12
Please see page 238 for more Series MD Accessories

*If the input and output connections are different, please add both values when ordering. Example: MD1-R000-1/8-1/4

Series MD Lockable Isolation 3/2-Way Valves

Connections with interchangeable cartridges: threaded (1/8, 1/4, 3/8) or integrated with super-rapid fitting for tube with Ø 6, 8 and 10mm

Modular assembly



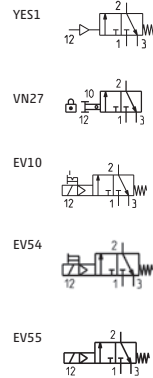

Manual, electro-pneumatic, servo-pilot and pneumatic control

Full Data Sheet and Dimensions at <https://store.camozzi.co.uk>



- ✓ Ex Stock
- ✂ UK Assembly
- ☎ Please Call Sales Office

ACCESSORIES

Part Number	Availability	Symbol	Connection	Mounting Bracket	Coil
Pneumatic Control					
MD1-V36	✓	YES1	-	 MD1-ST/1	N/A
MD1-V36-1/8	✓	YES1	1/8		
MD1-V36-1/4	✓	YES1	1/4		
MD1-V36-3/8	✓	YES1	3/8		
MD1-V36-6	✓	YES1	Ø6		
MD1-V36-8	✓	YES1	Ø8		
MD1-V36-10	✓	YES1	Ø10		
Lockable Manual Control					
MD1-V01	✓	VN27	-	 MD1-ST/1	N/A
MD1-V01-1/8	✓	VN27	1/8		
MD1-V01-1/4	✓	VN27	1/4		
MD1-V01-3/8	✓	VN27	3/8		
MD1-V01-6	✓	VN27	Ø6		
MD1-V01-8	✓	VN27	Ø8		
MD1-V01-10	✓	VN27	Ø10		
Electro-Pneumatic Control					
MD1-V16*	✓	EV10/EV54/EV55	-	 MD1-ST/1	 U7
MD1-V16*-1/8	✓	EV10/EV54/EV55	1/8		
MD1-V16*-1/4	✓	EV10/EV54/EV55	1/4		
MD1-V16*-3/8	✓	EV10/EV54/EV55	3/8		
MD1-V16*-6	✓	EV10/EV54/EV55	Ø6		
MD1-V16*-8	✓	EV10/EV54/EV55	Ø8		
MD1-V16*-10	✓	EV10/EV54/EV55	Ø10		
Please see page 238 for more Series MD Accessories					

*If the input and output connections are different, please add both values when ordering. Example: MD1-V01-1/8-1/4

*Other options of manual override available on request.

CODING EXAMPLE

MD	1	-	V	01	-	1/8
MD SERIES: MD	1 SIZE: 1 = 42mm			01 DESIGN TYPE: 01 = lockable manual control 16 = electro-pneumatic control, Push & Turn manual override 16IL = electro-pneumatic control, bistable manual override, lever type (EV10) 16IM = electro-pneumatic control, monostable manual override (EV54) 16IT = electro-pneumatic control without manual override (EV55) 36 = pneumatic control		
V 3/2 WAY VALVE		1/8		CONNECTIONS (IN/OUT*): = no connection 1/8, 1/4, 3/8, 6, 8, 10		

Series MD Soft Start Valves

Connections with interchangeable cartridges: threaded (1/8, 1/4, 3/8) or integrated with super-rapid fitting for tube with \varnothing 6, 8 and 10mm
Modular assembly

Full Data Sheet and Dimensions at <https://store.camozzi.co.uk>



AVP1



- ✓ Ex Stock
- ✎ UK Assembly
- ☎ Please Call Sales Office

Part Number	Availability	Connection
MD1-AV	✓	-
MD1-AV-1/8	✓	1/8
MD1-AV-1/4	✓	1/4
MD1-AV-3/8	✓	3/8

Part Number	Availability	Connection
MD1-AV-6	✓	\varnothing 6
MD1-AV-8	✓	\varnothing 8
MD1-AV-10	✓	\varnothing 10

*If the input and output connections are different, please add both values when ordering. Example: MD1-AV-1/8-1/4
Please see page 238 for Series MD Accessories

CODING EXAMPLE

MD	1	-	AV	-	1/8
----	---	---	----	---	-----

MD	SERIES: MD	
1	SIZE: 1 = 42mm	1/8 CONNECTIONS (IN/OUT*): = no connection 1/8, 1/4, 3/8, 6, 8, 10
AV	SOFT START VALVE	

Series MD Take-off Blocks

Module with interchangeable cartridges: threaded (1/8, 1/4, 3/8) or integrated with super-rapid fitting for tube with \varnothing 6, 8 and 10 mm (4 outlets) Intermediate junction cartridge (2 outlets) Intermediate junction cartridge with non-return valve

Full Data Sheet and Dimensions at <https://store.camozzi.co.uk>



BL01



- ✓ Ex Stock
- ✎ UK Assembly
- ☎ Please Call Sales Office

Part Number	Availability	Connection
MD1-B00	✓	-
MD1-B00-1/8	✓	1/8
MD1-B00-1/4	✓	1/4
MD1-B00-3/8	✓	3/8
MD1-B00-6	✓	\varnothing 6
MD1-B00-8	✓	\varnothing 8
MD1-B00-10	✓	\varnothing 10

CODING EXAMPLE

MD	1	-	B	00	-	1/8
----	---	---	---	----	---	-----

MD	SERIES: MD	
1	SIZE: 1 = 42mm	00 DESIGN TYPE: 00 = without no return valve (standard) 02 = bidirectional derivation
B	TAKE-OFF BLOCK	1/8 CONNECTIONS (IN/OUT*): = no connection 1/8, 1/4, 3/8, 6, 8, 10

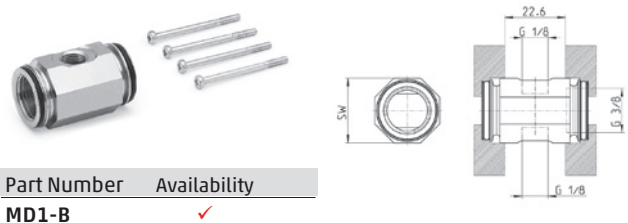

*If the input and output connections are different, please add both values when ordering. Example: MD1-B00-1/8-1/4
Please see page 238 for Series MD Accessories

Series MD FRL Assembled

Connections with interchangeable cartridges: threaded (1/8, 1/4, 3/8) or integrated with super-rapid fitting for tube with Ø 6, 8 and 10mm
Modular assembly

Full Data Sheet and Dimensions at <https://store.camozzi.co.uk>

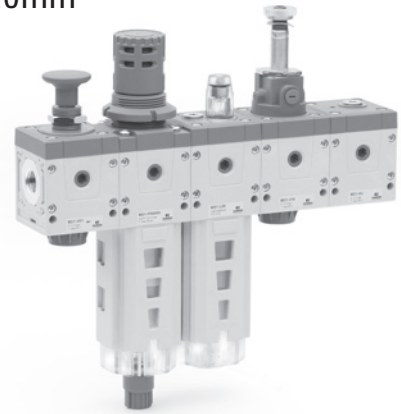

CODING EXAMPLE

MD	1	-	000014	-	1/4
-----------	----------	---	---------------	---	------------

MD	SERIES: MD	
1	SIZE: 1 = 42mm	1/4 CONNECTIONS (IN/OUT): = no connection 1/8, 1/4, 3/8, 6, 8, 10
000014	<p>GROUP COMPOSITION (25 micron):</p> <p>000014 = F000 + R000 + L00 000015 = FR0000 + L00 000016 = V01 + FR0000 + L00 000017 = V01 + FR0000 000018 = FR0000 + V16 + AV 000019 = FR0000 + L00 + V16 + AV 000020 = V01 + FR0000 + V16 + AV 000021 = V01 + FR0000 + L00 + V16 + AV + PRESS. NO 000022 = V01 + FR0000 + L00 + V16 + AV + PRESS. NC 000023 = V01 + FR0000 + V16 + AV + PRESS. NO 000024 = V01 + FR0000 + V16 + AV + PRESS. NC</p>	<p>GROUP COMPOSITION (5 micron):</p> <p>000025 = F100 + R000 + L00 000026 = FR1000 + L00 000027 = V01 + FR1000 + L00 000028 = V01 + FR1000 000029 = FR1000 + V16 + AV 000030 = FR1000 + L00 + V16 + AV 000031 = V01 + FR1000 + V16 + AV 000032 = V01 + FR1000 + L00 + V16 + AV + PRESS. NO 000033 = V01 + FR1000 + L00 + V16 + AV + PRESS. NC 000034 = V01 + FR1000 + V16 + AV + PRESS. NO 000035 = V01 + FR1000 + V16 + AV + PRESS. NC 000036 = F150 + FC050</p>

Please see page 238 for Series MD Accessories

UK Assembled Multipole Valve Islands

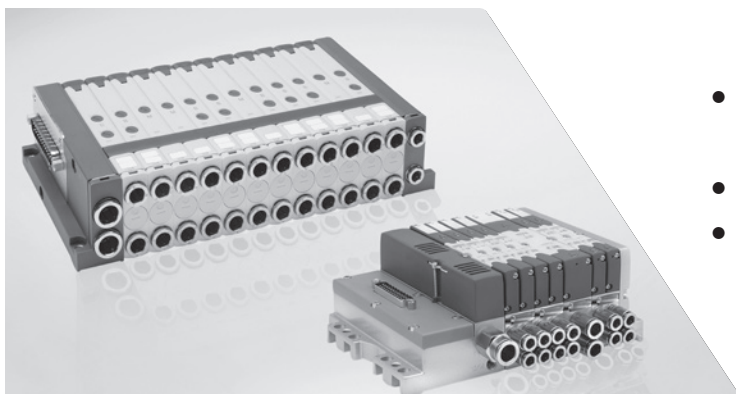

- Series HN
(37 Pin, 32 Coils or 25 Pin, 24 Coils)
- Series F (25 Pin, 24 Coils)
- Next Day Delivery

Composition of the assembled group 000014 and 000025

Components:
Filter
Regulator
Lubricator
Pressure Gauge
Bracket

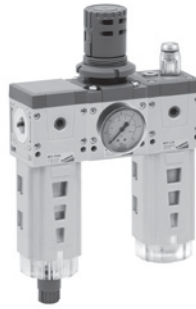

- ✓ Ex Stock
- ✎ UK Assembly
- ⓞ Please Call Sales Office

25 micron filtering element			5 micron filtering element		
Part Number	Availability	Connections	Part Number	Availability	Connections
MD1-000014-1/8	✎	1/8	MD1-000025-1/8	✎	1/8
MD1-000014-1/4	✎	1/4	MD1-000025-1/4	✎	1/4
MD1-000014-3/8	✎	3/8	MD1-000025-3/8	✎	3/8
MD1-000014-6	✎	6	MD1-000025-6	✎	6
MD1-000014-8	✎	8	MD1-000025-8	✎	8
MD1-000014-10	✎	10	MD1-000025-10	✎	10

Composition of the assembled group 000015 and 000026

Components:
Filter-regulator
Lubricator
Pressure Gauge
Bracket



- ✓ Ex Stock
- ✎ UK Assembly
- ⓞ Please Call Sales Office

25 micron filtering element			5 micron filtering element		
Part Number	Availability	Connections	Part Number	Availability	Connections
MD1-000015-1/8	✎	1/8	MD1-000026-1/8	✎	1/8
MD1-000015-1/4	✎	1/4	MD1-000026-1/4	✎	1/4
MD1-000015-3/8	✎	3/8	MD1-000026-3/8	✎	3/8
MD1-000015-6	✎	6	MD1-000026-6	✎	6
MD1-000015-8	✎	8	MD1-000026-8	✎	8
MD1-000015-10	✎	10	MD1-000026-10	✎	10

Composition of the assembled group 000016 and 000027

Components:
Lockable isolation 3/2 valve
Filter-regulator
Lubricator
Pressure Gauge
Bracket

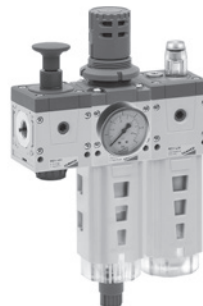

- ✓ Ex Stock
- ✎ UK Assembly
- ⓞ Please Call Sales Office

25 micron filtering element			5 micron filtering element		
Part Number	Availability	Connections	Part Number	Availability	Connections
MD1-000016-1/8	✎	1/8	MD1-000027-1/8	✎	1/8
MD1-000016-1/4	✎	1/4	MD1-000027-1/4	✎	1/4
MD1-000016-3/8	✎	3/8	MD1-000027-3/8	✎	3/8
MD1-000016-6	✎	6	MD1-000027-6	✎	6
MD1-000016-8	✎	8	MD1-000027-8	✎	8
MD1-000016-10	✎	10	MD1-000027-10	✎	10

Please see page 238 for Series MD Accessories

Composition of the assembled group 000017 and 000028

- Components:
Lockable isolation 3/2 valve
Filter-regulator
Pressure Gauge
Bracket



- ✓ Ex Stock
- ✎ UK Assembly
- ☎ Please Call Sales Office

25 micron filtering element		
Part Number	Availability	Connections
MD1-000017-1/8	✎	1/8
MD1-000017-1/4	✎	1/4
MD1-000017-3/8	✎	3/8
MD1-000017-6	✎	6
MD1-000017-8	✎	8
MD1-000017-10	✎	10

5 micron filtering element		
Part Number	Availability	Connections
MD1-000028-1/8	✎	1/8
MD1-000028-1/4	✎	1/4
MD1-000028-3/8	✎	3/8
MD1-000028-6	✎	6
MD1-000028-8	✎	8
MD1-000028-10	✎	10

Composition of the assembled group 000018 and 000029

- Components:
Filter-regulator
Isolation 3/2 valve
Soft start valve
Pressure Gauge
Bracket



- ✓ Ex Stock
- ✎ UK Assembly
- ☎ Please Call Sales Office

25 micron filtering element		
Part Number	Availability	Connections
MD1-000018-1/8	✎	1/8
MD1-000018-1/4	✎	1/4
MD1-000018-3/8	✎	3/8
MD1-000018-6	✎	6
MD1-000018-8	✎	8
MD1-000018-10	✎	10

5 micron filtering element		
Part Number	Availability	Connections
MD1-000029-1/8	✎	1/8
MD1-000029-1/4	✎	1/4
MD1-000029-3/8	✎	3/8
MD1-000029-6	✎	6
MD1-000029-8	✎	8
MD1-000029-10	✎	10

Composition of the assembled group 000019 and 000030

- Components:
Filter-regulator
Lubricator
Isolation 3/2 valve
Soft start valve
Pressure Gauge
Bracket

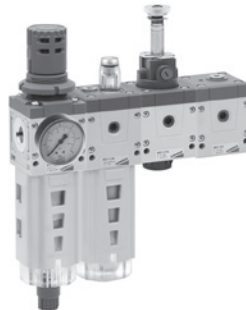

- ✓ Ex Stock
- ✎ UK Assembly
- ☎ Please Call Sales Office

25 micron filtering element		
Part Number	Availability	Connections
MD1-000019-1/8	✎	1/8
MD1-000019-1/4	✎	1/4
MD1-000019-3/8	✎	3/8
MD1-000019-6	✎	6
MD1-000019-8	✎	8
MD1-000019-10	✎	10

5 micron filtering element		
Part Number	Availability	Connections
MD1-000030-1/8	✎	1/8
MD1-000030-1/4	✎	1/4
MD1-000030-3/8	✎	3/8
MD1-000030-6	✎	6
MD1-000030-8	✎	8
MD1-000030-10	✎	10

Please see page 238 for Series MD Accessories

Series MD Accessories for FRL

- ✓ Ex Stock
- 🇬🇧 UK Assembly
- ☎ Please Call Sales Office

Threaded Cartridges MD1-A-...

The kit is supplied with:

- 2x nickel-plated threaded cartridges
- 4x special white zinc-plated screws Ø4.5 TC/RC



Part Number	Availability
MD1-A-1/8	✓
MD1-A-1/4	✓
MD1-A-3/8	✓

Integrated Cartridges with super-rapid fitting MD1-A-...

The kit is supplied with:

- 2x integrated nickel-plated cartridges with super-rapid fitting
- 4x special white zinc-plated screws Ø4.5 TC/RC



Part Number	Availability
MD1-A-6	✓
MD1-A-8	✓
MD1-A-10	✓

Intermediate Joining Cartridge MD1-C

The kit is supplied with:

- 1x intermediate joining cartridge
- 4x special white zinc-plated screws Ø4.5 TC/RC



Part Number	Availability
MD1-C	✓

Screws for wall mounting MD1-D

The kit is supplied with:

- 2x white zinc-plated screws M4x50



Part Number	Availability
MD1-D	✓

Mounting Bracket MD1-ST/1

The kit is supplied with:

- 1x zinc-plated bracket
- 2x white zinc-plated screws M4x50



Part Number	Availability
MD1-ST/1	✓

Mounting Bracket C114-ST

For regulators and filter-regulators (1/4-1/8)

The kit is supplied with:

- 1x zinc-plated steel bracket

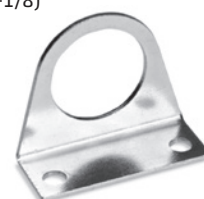

Part Number	Availability
C114-ST	✓

Mounting Bracket C114-ST/1

For regulators and filter-regulators (1/4-1/8)

The kit is supplied with:

- 1x zinc-plated steel bracket
- 2x white zinc-plated screws M4x50



Part Number	Availability
C114-ST/1	✓

Mounting Bracket C114-ST/2

For regulators and filter-regulators (1/4-1/8)

The kit is supplied with:

- 1x zinc-plated steel bracket



Part Number	Availability
C114-ST/2	✓

Series N Filter and Coalescing Filters

Connections: 1/8 and 1/4

with screw-on transparent bowl

Full Data Sheet and Dimensions at <https://store.camozzi.co.uk>

AIR TREATMENT



- ✓ Ex Stock
- 🔧 UK Assembly
- 📞 Please Call Sales Office

CODING EXAMPLE

N	2	04	-	F	0	0	-	
N	SERIES: N			0	FILTERING ELEMENT: 0 = 25µm (standard) 1 = 5µm B = 0.01µm CA = activated carbon (without drain, only closed bowl size 2)			
2	SIZE: 1 = small bowl (11cm ³) 2 = standard bowl (28cm ³)			0	DRAINING OF CONDENSATE: 0 = manual, semi-automatic 4 = depressurisation (normal cup only) 5 = depressurisation, protected (normal cup only) 8 = connection 1/8 exhaust, no drain see page 249			
04	CONNECTIONS: 08 = 1/8 04 = 1/4			BOWL MATERIAL: = transparent PA 12 (standard) TM = nickel-plated brass (only in the small size with semi-automatic manual drain or without drain)				
F	FILTER							



Semi Auto Drain	Availability	Symbol	1/8 Small Bowl	1/4 Small Bowl	1/8 Standard Bowl	1/4 Standard Bowl
25 micron	✓	FT02	N108 F00	N104 F00	N208 F00	N204 F00
5 micron	✓	FT02	N108 F10	N104 F10	N208 F10	N204 F10

Depressurisation Drain	Symbol	1/8 Standard Bowl	1/4 Standard Bowl
25 micron	✓ FT03	N208 F04	N204 F04
5 micron	✓ FT03	N208 F14	N204 F14

Depressurisation Drain Protected	Symbol	1/8 Standard Bowl	1/4 Standard Bowl
25 micron	✓ FT03	N208 F05	N204 F05
5 micron	✓ FT03	N208 F15	N204 F15

Connection 1/8	Symbol	1/8 Small Bowl	1/4 Small Bowl	1/8 Standard Bowl	1/4 Standard Bowl
25 micron	✓ FT01	N108 F08	N104 F08	N208 F08	N204 F08
5 micron	✓ FT01	N108 F18	N104 F18	N208 F18	N204 F18

Coalescing Filter 0.01 micron	Symbol	1/8 Small Bowl	1/4 Small Bowl	1/8 Standard Bowl	1/4 Standard Bowl
Semi Auto Drain	✓ FT01	N108 FB0	N104 FB0	N208 FB0	N204 FB0
Depressurisation Drain	✓ FT03			N208 FB4	N204 FB4
Depressurisation Drain Protected	✓ FT03			N208 FB5	N204 FB5
Connection 1/8	✓ FT01	N108 FB8	N104 FB8	N208 FB8	N204 FB8

Accessories	1/8	1/4	1/8	1/4
	2500 1/8	2500 1/4	2500 1/8	2500 1/4
	N204-ST	N204-ST	N204-ST	N204-ST

Please see page 241 for additional Series N accessories

Series N Pressure Regulators

Connections: 1/8, 1/4

Full Data Sheet and Dimensions at <https://store.camozzi.co.uk>

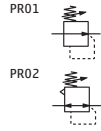

CODING EXAMPLE

N	12	04	-	R	T	0	-	■	-	●
---	----	----	---	---	---	---	---	---	---	---

N	SERIES: N	T	OPERATING PRESSURE: 0 = 0.5 - 10 bar (standard) 1 = 0 - 4 bar, 2 = 0 - 2 bar 7 = 0.5 - 7 bar, T = calibrated B = locked*
12	SIZE: 12	0	DESIGN TYPE: 0 = self-relieving 1 = non-relieving
04	CONNECTIONS: 08 = 1/8 04 = 1/4	R	REGULATOR

*NOTE: IF THE REGULATOR IS CALIBRATED OR LOCKED, AFTER THE DESIGN TYPE ADD THE INLET PRESSURE " " AND THE OUTLET PRESSURE " "
Example of a calibrated regulator with Inlet Pressure = 6.3 bar and Outlet Pressure = 4.5 bar
Complete part number: N1204-RT0-6.3-4.5

Self Relieving	Availability	Symbol	1/8	1/4	Non Relieving	Availability	Symbol	1/8	1/4
0.5 - 10 bar	✓	PR02	N1208 R00	N1204 R00	0.5 - 10 bar	✓	PR01	N1208 R01	N1204 R01
0 - 4 bar	✓	PR02	N1208 R10	N1204 R10	0 - 4 bar	✓	PR01	N1208 R11	N1204 R11
Accessories			1/8	1/4	1/8	1/4			
			2500 1/8	2500 1/4	2500 1/8	2500 1/4			
			C114-ST	C114-ST	C114-ST	C114-ST			

Series N Lubricator

Connections: 1/8, 1/4

with screw-on transparent bowl

Full Data Sheet and Dimensions at <https://store.camozzi.co.uk>



CODING EXAMPLE

N	2	04	-	L	00	-	
---	---	----	---	---	----	---	--

N	SERIES: N	L	LUBRICATOR
2	SIZE: 1 = small bowl (26cm ³) 2 = standard bowl (37cm ³)	00	DESIGN TYPE: 00 = atomized oil
04	CONNECTIONS: 08 = 1/8 04 = 1/4	BOWL MATERIAL: = transparent PA12 (standard) TM = nickel-plated brass (only in the small size)	

- ✓ Ex Stock
- 🔧 UK Assembly
- ☎ Please Call Sales Office

Availability	1/8	1/4	Availability	1/8	1/4	
✓	N108 L00	N104 L00	✓	N208 L00	N204 L00	
Accessories			1/8	1/4	1/8	1/4
			2500 1/8	2500 1/4	2500 1/8	2500 1/4

Series N Filter/Regulators

Full Data Sheet and Dimensions at <https://store.camozzi.co.uk>

AIR TREATMENT



CODING EXAMPLE

N	2	04	-	D	0	0	-	4	-
---	---	----	---	---	---	---	---	---	---

N	SERIES: N	0	DRAINING OF CONDENSATE: 0 = semi-automatic, manual drain with self-relieving 1 = semi-automatic, manual drain non-relieving 4 = depressurisation, self-relieving (with normal bowl only) 5 = depressurisation, protected (with normal bowl only) 8 = connection 1/8, with self-relieving
2	SIZE: 1 = small bowl (11cm ³) 2 = standard bowl (28cm ³)		
04	CONNECTIONS: 08 = 1/8 04 = 1/4		
D	D = FILTER/REGULATOR	4	OPERATING PRESSURE: = 0.5 - 10 bar (standard) 2 = 0 - 2 bar 4 = 0 - 4 bar 7 = 0.5 - 7 bar
0	FILTERING ELEMENT: 0 = 25µm (standard) 1 = 5µm		
BOWL MATERIAL: = transparent PA12 (standard) TM = nickel-plated brass (only in the small size with semi-automatic manual drain or without drain)			

- ✓ Ex Stock
- ✎ UK Assembly
- ☎ Please Call Sales Office

Semi Auto Drain

Self Relieving	Availability	Symbol	1/8 Small Bowl	1/4 Small Bowl	1/8 Standard Bowl	1/4 Standard Bowl
25 micron	✓	FR01	N108 D00	N104 D00	N208 D00	N204 D00
5 micron	✓	FR01	N108 D10	N104 D10	N208 D10	N204 D10

Non Relieving	Availability	Symbol	1/8 Small Bowl	1/4 Small Bowl	1/8 Standard Bowl	1/4 Standard Bowl
25 micron	✓	FR02	N108 D01	N104 D01	N208 D01	N204 D01
5 micron	✓	FR02	N108 D11	N104 D11	N208 D11	N204 D11

Accessories	1/8	1/4	1/8	1/4
	2500 1/8	2500 1/4	2500 1/8	2500 1/4

Series N Accessories for FRL

- ✓ Ex Stock
- ✎ UK Assembly
- ☎ Please Call Sales Office

Mounting Bracket Series N
F-L (for 1/8, 1/4).
Complete with: 2 screw M5x6



Part Number	Availability
N204-ST	✓

Mounting Bracket. Series MC-N-M
R-D (1/8 - 1/4)

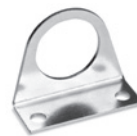

Part Number	Availability
C114-ST	✓

Mounting Bracket. Series MC-N-M
R-D (1/8 - 1/4)



Part Number	Availability
C114-ST/1	✓

Mounting Bracket. Series MC-N-M
R-D (1/8 - 1/4)



Part Number	Availability
C114-ST/2	✓

New models

Series CLR Micro Pressure Regulators

Connections: 1/8, 1/4

With banjo stem with or without relieving
Available with or without banjo



Technical Data
Type of Construction
 Piston regulator
Inlet Pressure
 2 to 10 bar
Outlet Pressure
 0.5 to 10 bar
Operating Temperature
 -5°C to +50°C
Materials
 Brass, technopolymer, NBR
Mountings
 In-line or panel mounting
 (in any position)
Special Requests
 For assistance, contact our technical office or your local Camozzi distributor.

- ✓ Ex Stock
- ✚ UK Assembly
- ☎ Please Call Sales Office

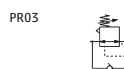

Full Data Sheet and Dimensions at <https://store.camozzi.co.uk>

CODING EXAMPLE

CL	R	1/8	-	01	-	4
-----------	----------	------------	----------	-----------	----------	----------

CL SERIES: CL	01 DESIGN TYPE: = with relieving 01 = without relieving
R REGULATOR	
1/8 CONNECTIONS: 1/8, 1/4	4 DIAMETER: = without banjo 4 = single technopolymer banjo with tube diameter Ø4 mm (only CLR 1/8) 6 = single technopolymer banjo with tube diameter Ø6 mm 8 = single technopolymer banjo with tube diameter Ø8 mm 1/8L = single metal banjo with thread G1/8 (only CLR 1/8) 1/8D = double metal banjo with double thread G1/8 (only CLR 1/8)

Micro pressure regulators with banjo

Part Number	Availability
CLR 1/8-4	✓
CLR 1/8-6	✓
CLR 1/8-8	✓
CLR 1/4-6	✓
CLR 1/4-8	✓

Micro pressure regulators without banjo

Part Number	Availability
CLR 1/8	✓
CLR 1/4	✓

Micro pressure regulators with double banjo

Part Number	Availability
CLR 1/8-1/8D	✓

Micro pressure regulators with banjo

Part Number	Availability
CLR 1/8-1/8D	✓

Flow Diagrams at 6 bar with ΔP1

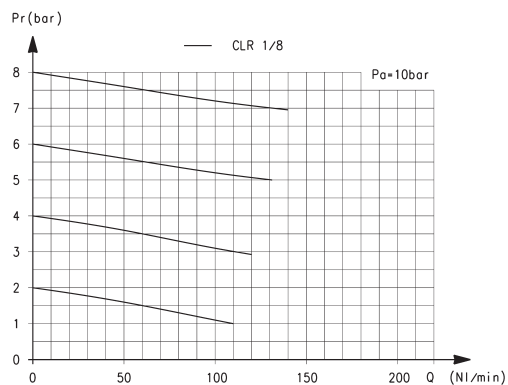
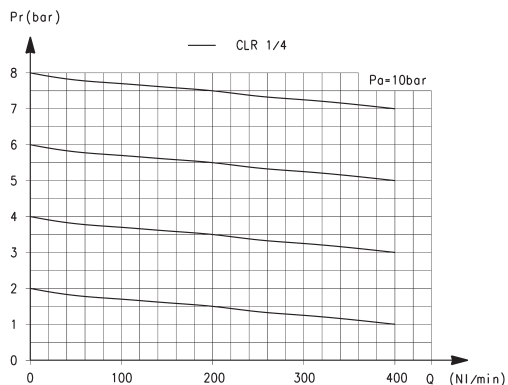

Pa = Inlet pressure (bar)
 Pr = Regulated pressure (bar)
 Q = Flow (NI/min)

CLR 1/4-6 = 209 NI/min
 CLR 1/4-8 = 310 NI/min

Pa = Inlet pressure (bar)
 Pr = Regulated pressure (bar)
 Q = Flow (NI/min)

CLR 1/8-4 = 90 NI/min
 CLR 1/8-6 = 120 NI/min
 CLR 1/8-8 = 120 NI/min

Series M Pressure Micro Regulators

Connections: 1/8, 1/4

Full Data Sheet and Dimensions at <https://store.camozzi.co.uk>

AIR TREATMENT



*High relief flow available on request

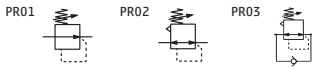

CODING EXAMPLE



M 0 04 - R T 0 2 - VS - ■ - ●

M	SERIES: M		
0	SIZE: 0	0	DESIGN TYPE: 0 = self-relieving 1 = non-relieving 5 = precise setting
04	CONNECTIONS: 08 = 1/8 04 = 1/4		
R	REGULATOR	2	PRESSURE GAUGE: = without pressure gauge 1 = with pressure gauge 0-2.5, with working pressure 0-2 bar 2 = with pressure gauge 0-6, with working pressure 0-4 bar 3 = with pressure gauge 0-10, with working pressure 0.5-7 bar 4 = with pressure gauge 0-12, with working pressure 0.5 - 10 bar
T	OPERATING PRESSURE: 0 = 0.5 - 10 bar (standard) 1 = 0 - 4 bar 2 = 0 - 2 bar 7 = 0.5 - 7 bar T = calibrated* B = locked*		
		VS	REGULATION TYPE: = without high relief flow (standard) VS = high relief flow
<p>*NOTE: IF THE REGULATOR IS CALIBRATE OR LOCKED, AFTER THE REGULATION TYPE ADD THE INLET PRESSURE "■" AND THE OUTLET PRESSURE "●"</p> <p>INLET PRESSURE: ■ = enter the SUPPLY pressure value</p> <p>OUTLET PRESSURE: ● = enter the OUTLET pressure value for the LOCKED regulator or the maximum value of the ADJUSTABLE pressure for the CALIBRATED regulator</p> <p>Example of a calibrated regulator with Inlet Pressure = 6.3 bar and Outlet Pressure = 4.5 bar</p>			

- ✓ Ex Stock
- 🇬🇧 UK Assembly
- ☎ Please Call Sales Office

Self Relieving	Availability	Symbol	1/8	1/4	Non Relieving	Availability	Symbol	1/8	1/4
0.5 - 10 bar	✓	PRO2	M008 R00	M004 R00	0.5 - 10 bar	✓	PRO1	M008 R01	M004 R01
0 - 4 bar	✓	PRO2	M008 R10	M004 R10	0 - 4 bar	✓	PRO1	M008 R11	N004 R11

Precise Setting	Availability	Symbol	1/8	1/4	Precise Setting	Availability	Symbol	1/8	1/4
0.5 - 10 bar	✓	PRO2	M008 R05	M004 R05	0 - 4 bar	✓	PRO1	M008 R15	M004 R15

Accessories	1/8	1/4	1/8	1/4
	S6510 6-1/8	S6510 6-1/4	S6510 6-1/8	S6510 6-1/4
	S6520 6-1/8	S6520 6-1/4	S6520 6-1/8	S6520 6-1/4
	C114-ST	C114-ST	C114-ST	C114-ST

Series T Pressure Micro Regulators

Connections: 1/8, 1/4

Full Data Sheet and Dimensions at <https://store.camozzi.co.uk>

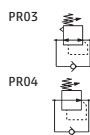

CODING EXAMPLE

T	1	08	-	R	0	0	2
T	SERIES: T			0	DESIGN TYPE: 0 = self-relieving 1 = non-relieving		
1	SIZE: 1						
08	CONNECTIONS: 08 = 1/8 04 = 1/4			2	PRESSURE GAUGE:** = without pressure gauge (standard) 1 = with pressure gauge 0-2.5, with working pressure 0-2 bar 2 = with pressure gauge 0-6, with working pressure 0-4 bar 3 = with pressure gauge 0-10, with working pressure 0.5-7 bar 4 = with pressure gauge 0-12, with working pressure 0.5-10 bar		
R	REGULATOR						
0	OPERATING PRESSURE: 0 = 0.5 - 10 bar 1 = 0 - 4 bar 2 = 0 - 2 bar 7 = 0 - 7 bar (standard)				** the pressure gauges are supplied disassembly pressure gauges mod. M043-P..		

- ✓ Ex Stock
- ✎ UK Assembly
- ☎ Please Call Sales Office

Self Relieving	Availability	Symbol	1/8	1/4	Non Relieving	Availability	Symbol	1/8	1/4
0.5 - 10 bar	✓	PR03	T108 R00	T104 R00	0.5 - 10 bar	✓	PR04	T108 R01	T104 R01
0 - 4 bar	✓	PR03	T108 R10	T104 R10	0 - 4 bar	✓	PR04	T108 R11	T104 R11
0 - 2 bar	✓	PR03	T108 R20	T104 R20	0 - 2 bar	✓	PR04	T108 R21	T104 R21
0 - 7 bar	✓	PR03	T108 R70	T104 R70	0 - 7 bar	✓	PR04	T108 R71	T104 R71

Accessories	1/8	1/4	1/8	1/4
	S6510 6-1/8	S6510 8-1/4	S6510 6-1/8	S6510 8-1/4
	S6520 6-1/8	S6520 8-1/4	S6520 6-1/8	S6520 8-1/4
	C114-ST	C114-ST	C114-ST	C114-ST

Series M and T Accessories for FRL

- ✓ Ex Stock
- ✎ UK Assembly
- ☎ Please Call Sales Office

Mounting Bracket. Series MC-N-M R-D (1/8 - 1/4)

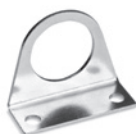

Part Number	Availability
C114-ST	✓

Mounting Bracket. Series MC-N-M R-D (1/8 - 1/4)



Part Number	Availability
C114-ST/1	✓

Mounting Bracket. Series MC-N-M R-D (1/8 - 1/4)



Part Number	Availability
C114-ST/2	✓

Series PR Precision Regulators with Manual Override

Size 1 Connection: 1/4

Size 2 Connections: 1/4, 3/8



CODING EXAMPLE

PR	1	04	-	M	07
----	---	----	---	---	----

PR	SERIES: PR	
1	SIZE: 1 = Size 1 2 = Size 2	M TYPE OF ADJUSTMENT: M = Manual
04	CONNECTIONS: 04 = 1/4 38 = 3/8 (size 2 only)	07 OPERATING PRESSURE: (1 bar = 14.5psi) 02 = 0.05 - 2 bar 04 = 0.05 - 4 bar 07 = 0.05 - 7 bar (standard) 00 = 0.05 - 10 bar

Series PM Adjustable-Diaphragm Pressure Switches

Series PM: adjustable-diaphragm pressure switches, with setting visual scale, with exchange contacts

Series TRP: electro-pneumatic transducers

Series 2950: pressure indicators, ports M5

Normally closed (NC) or open (NO).

Connections: 1/8.

Supplied with a rubber cap protection class IP54

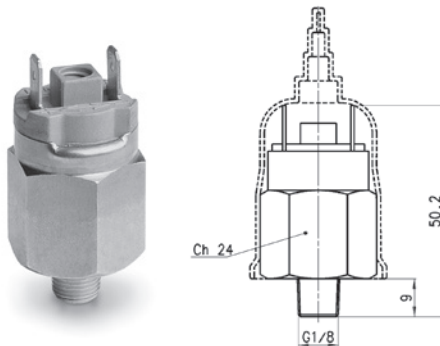

- ✓ Ex Stock
- ✎ UK Assembly
- ☎ Please Call Sales Office



Pressure Switch	Availability	Max. Voltage	Max Power	Service Type	Insulation Voltage	Symbol
PM11-NC	✓	48 V AC DC	24 VA	Heavy	500V	PMNC
PM11-NA	✓	48 V AC DC	24 VA	Heavy	500V	PMNA

NC = The pressure switch opens an electric contact when it reaches the fixed pressure.
NA = The pressure switch closes an electric contact when it reaches the fixed pressure.

Series PM Pressure Switch with Exchange Contacts

Normally closed or open
Connections: 1/4.
Protection class IP65
(with connector 124-830)

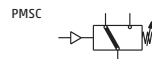

- ✓ Ex Stock
- ✎ UK Assembly
- ☎ Please Call Sales Office

Pressure Switch	Availability	Max. Voltage	Operating Temperature	Actuation Time	Setting Range	Max Hysteresis
PM11-SC	✓	250 V AC - 30 V DC	-25°C to +85°C	>0.1 ms	2-10 Bar	0.8 bar

SC = Contacts of exchange For electrical connector to suit PM11-SC, Please use KA042000B9

Series TRP Electro-Pneumatic Transducer

Normally closed or open



- ✓ Ex Stock
- ✎ UK Assembly
- ⌚ Please Call Sales Office

Part Number	Availability
TRP-8	⌚

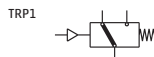

Series 2950 Pressure indicator

Connections: M5.



- ✓ Ex Stock
- ✎ UK Assembly
- ⌚ Please Call Sales Office

Part Number	Availability
2950 M5	✓



Series SWMN Electronic Vacuum/Pressure Switches in Mini Format

New

Connections: 1/8, M5 thread or Ø 4, 6 mm plug-in tube

Measuring range: 0 to -1 bar, 0 to 1 bar with analog output, 0 to -1 bar, 0 to 6 bar with digital PNP output



The Series SWMN vacuum/pressure switches can be installed directly at the measuring point or pressure/vacuum determination point in handling systems, thanks to its highly compact dimensions.

Its reduced weight (only 50 grams with a 2 meter cable) and robust construction allow its installation on applications with high accelerations.

The four types of connection enable a high flexibility and an easy installation inside machines or pneumatic cabinets.

For full technical data please visit <https://store.camozzi.co.uk>

CODING EXAMPLE

SWMN	-	AP	-	T	-	2
-------------	---	-----------	---	----------	---	----------

SWMN		SERIES: SWMN	
AP	OUTPUT SIGNAL: AV = analog output signal - vacuum AP = analog output signal - pressure NO = normally open NC = normally closed PN = PNP output - vacuum PP = PNP output - pressure	T	TYPE OF CONNECTION: T = Ø 6 tube U = Ø 4 tube G = G1/8 thread M = M5 thread
		2	ELECTRIC CONNECTION: 2 = cable of 2 meters M = M8 3 pin connector

Series SWDN Electronic Vacuum/Pressure Switches

With digital display
High precision, easy to use



APPLICATIONS:

- electronic vacuum/pressure switch for safety monitoring, optimization of cycle times or energy saving devices;
- it can be installed directly on the gripping point of a handling system;
- setting of the limit vacuum value and continuous vacuum control;
- perfectly suitable for customer needs.

ELECTRIC CONNECTION:

the device is available with hardwired cable of 2 meters or can be supplied with M8 connector. Accessories and extensions have to be ordered separately. Codes can be found at the end of this section.

CODING EXAMPLE

SWDN	-	V01	-	P3	-	2
-------------	---	------------	---	-----------	---	----------

SWDN SERIES: SWDN	
V01 SET PRESSURE RANGE: V01 = from -1 bar to 1 bar P10 = from 0 bar to 10 bar	P3 TYPE OF ELECTRIC CONNECTION: P3 = 2 PNP outputs + 1 analog output 1 - 5 V DC (this version is available with 5-pole cable only) P4 = 2 PNP outputs
2 ELECTRIC CONNECTION: 2 = cable of 2 meters M = M8 4 pin connector	

For full technical data please visit <https://store.camozzi.co.uk>

Series SWCN Electronic Vacuum/Pressure Switches

With digital display
High precision, easy to use



APPLICATIONS:

- electronic vacuum/pressure switch for safety monitoring, optimization of cycle times or energy saving devices;
- it can be installed directly on the gripping point of a handling system;
- setting of the limit vacuum value and continuous vacuum control;
- perfectly suitable for customer needs.

ELECTRIC CONNECTION:

the device is available with hardwired cable of 2 meters or can be supplied with M8 connector. Accessories and extensions have to be ordered separately. Codes can be found at the end of this section.

CODING EXAMPLE

SWCN	-	V01	-	P3	-	2
-------------	---	------------	---	-----------	---	----------

SWCN SERIES: SWCN	
V01 SET PRESSURE RANGE: V01 = from -1 bar to 1 bar P10 = from 0 bar to 10 bar	P3 TYPE OF ELECTRIC CONNECTION: P3 = 2 PNP outputs + 1 analog output 1 - 5 V DC (this version is available with 5-pole cable only) P4 = 2 PNP outputs
2 ELECTRIC CONNECTION: 2 = cable of 2 meters M = M8 3 pin connector	

For full technical data please visit <https://store.camozzi.co.uk>

Series GPB1 Pressure Switches

Compact pressure switch with plug-in or thread-in fitting, for non-corrosive and non-flammable gas

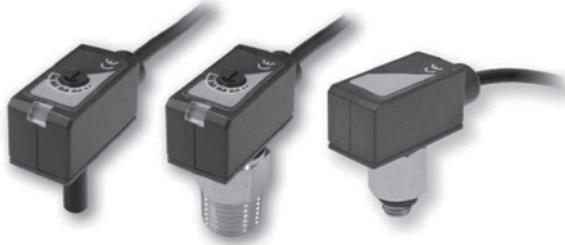

- ✓ Ex Stock
- ✂ UK Assembly
- ☎ Please Call Sales Office

Part Number	Availability
GPB1B5CM08	✓
GPB1C5CM08	✓

CODING EXAMPLE

GPB1	C	5	C	M08
GPB1	SERIES: GPB1	C		PRESSURE PORT: C = G1/8 - M5
C	PRESSURE RANGE: B = 0 to -101.3 kPa C = 0 to 1.0 MPa	M08		CONNECTION: M08 = M8
5	OUTPUT: 5 = PNP 6 = Analog. 1-5V			

For full technical data please visit <https://store.camozzi.co.uk>

Series GPB5 Pressure Switches

With hysteresis adjustable, IP40 for air, non-corrosive and non-flammable gas



- ✓ Ex Stock
- ✂ UK Assembly
- ☎ Please Call Sales Office

Part Number	Availability
GPB5C2CM08	✓
GPB5C3CC02	✓
GPB5C4CC02	✓
GPB5B2CM08	✓

CODING EXAMPLE

GPB5	C	2	C	M08
GPB5	SERIES: GPB5	C		PRESSURE PORT: C = 1/8 - M5
C	PRESSURE RANGE: B = 0 to -101.3 kPa C = 0 to 1.0 MPa	M08		CONNECTION: C02 = 2m M08 = M8
5	OUTPUT: 2 = 2 x PNP 3 = 1 x PNP + 1 x 1.5V 4 = 1 x PNP + 1 x 4-20 mA			

For full technical data please visit <https://store.camozzi.co.uk>

Series GPB5 Accessoires

GPB5S Vertical mounting brackets

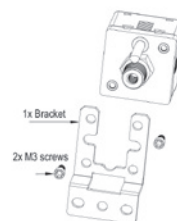

GPA5L Base mounting brackets

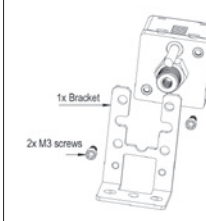

GPA5P Panel adapter

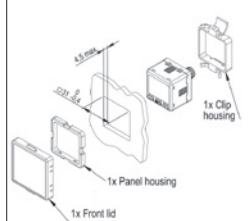

Dimension/Connection

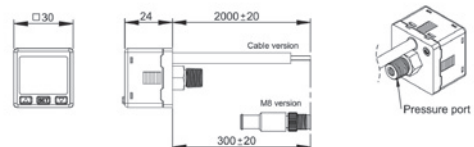

Pressure Gauges

Pressure gauges $\varnothing 43 - 53 - 63$ mm.
Other Pressure Gauges available on request

- ✓ Ex Stock
- ✎ UK Assembly
- ☎ Please Call Sales Office

Miniature Pressure Gauge

New



Part Number	Range
M015-P08	0 - 8 bar ✓

Pressure Gauges for Panel Mounting



Part Number	Connection	Range
M043-F04	1/8	0 - 4 bar ✓
M043-F06	1/8	0 - 6 bar ✓
M043-F12	1/8	0 - 12 bar ✓
M063-F12	1/4	0 - 12 bar ✓

Pressure Gauges with Radial Connection



Part Number	Connection	Range
M043-R06	1/8	0 - 6 bar ✓
M043-R12	1/8	0 - 12 bar ✓
M053-R12	1/8	0 - 12 bar ✓
M063-R12	1/4	0 - 12 bar ✓

Pressure Gauges with Rear connection



Part Number	Connection	Range
M043-P02.5	1/8	0 - 2.5 bar ✓
M043-P04	1/8	0 - 4 bar ✓
M043-P06	1/8	0 - 6 bar ✓
M043-P12	1/8	0 - 12 bar ✓
M053-P04	1/8	0 - 4 bar ✓
M053-P06	1/8	0 - 6 bar ✓
M053-P12	1/8	0 - 12 bar ✓
M063-P04	1/4	0 - 4 bar ✓
M063-P06	1/4	0 - 6 bar ✓
M063-P12	1/4	0 - 12 bar ✓

Built-in Pressure Gauge

New



Part Number	Range
MX3-R30/W-P	0 - 2.5 bar ✓
MX3-R31/W-P	0 - 6 bar ✓
MX3-R32/W-P	0 - 10 bar ✓
MX3-R33/W-P	0 - 12 bar ✓

For use with MX2-MX3 products

Series MD, MX, MC and N Functioning Condensate Drains

Semi-automatic manual drain Depressurisation drain, protected
Automatic drain
Depressurisation drain Connections: 1/8 (without drain)

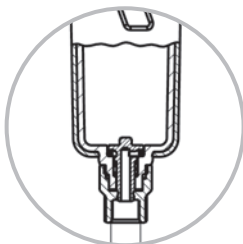

Semi-automatic - manual drain
Type 0 and 1

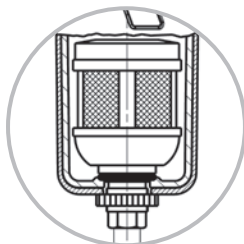

Automatic drain
Type 3

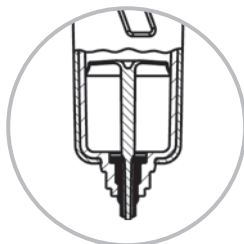

Depressurisation drain
Type 4

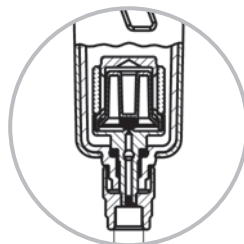

Depressurisation drain, protected
Type 5

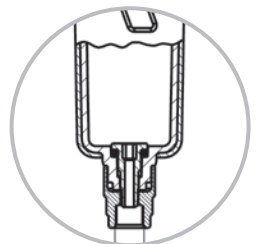

Connection 1/8 (without drain)
Type 8

Series PG Digital Pressure Gauges

Possibility of a direct mounting with rear or panel connection

Full Data Sheet and Dimensions at <https://store.camozzi.co.uk>

Series PG digital pressure gauges - battery-powered

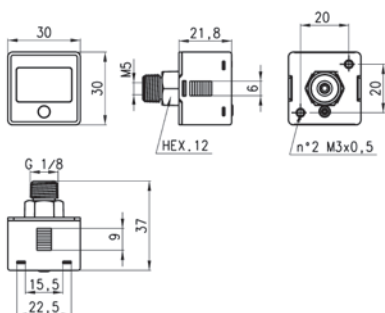

Series PG digital pressure gauges - with cable

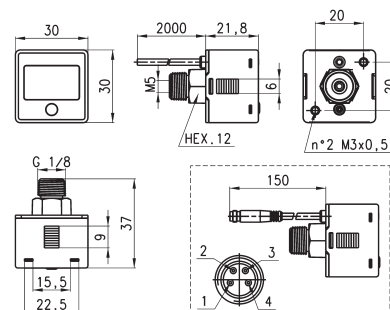

- ✓ Ex Stock
- ✂ UK Assembly
- ☎ Please Call Sales Office

Part Number	Availability
PG010-PB-1/8	☎
PG001-VB-1/8	☎
PG010-PB-1/4	☎
PG001-VB-1/4	☎

Part Number	Availability
PG010-PB-1/8-2	☎
PG001-VB-1/8-2	☎
PG010-PB-1/8-M	☎
PG001-VB-1/8-M	☎

CODING EXAMPLE

PG	010	-	P	B	-	1/8	-	2
PG	SERIES: PG		P	PRESSURE RANGE: P = Pressure V = Vacuum		1/8	PNEUMATIC CONNECTIONS: 1/8 = 1/8 BSPP; M5 1/4 = 1/4 BSPP; M5 (for battery-powered version only)	
010	BOTTOM SCALE: 010 = 10 bar 001 = -1 bar		B	LIGHTING: B = Back Light		2	ELECTRICAL CONNECTION (for version with cable only): 2 = with unshielded 2-pole cable of 2m M = with cable of 150mm and M8 4-pole connector	

Accessories

Mounting Bracket
Supplied with:
1x bracket type A
1x bracket type B
2x screws M3x6



Panel Mounting Adapter
Supplied with:
1x bracket type A
1x bracket type B

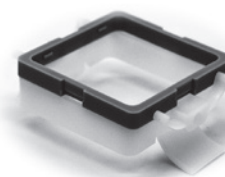

Part Number	Availability
PG-B	☎

Part Number	Availability
PG-F	☎

AIR TREATMENT BOX SETS REDUCE COSTS AND SAVE TIME

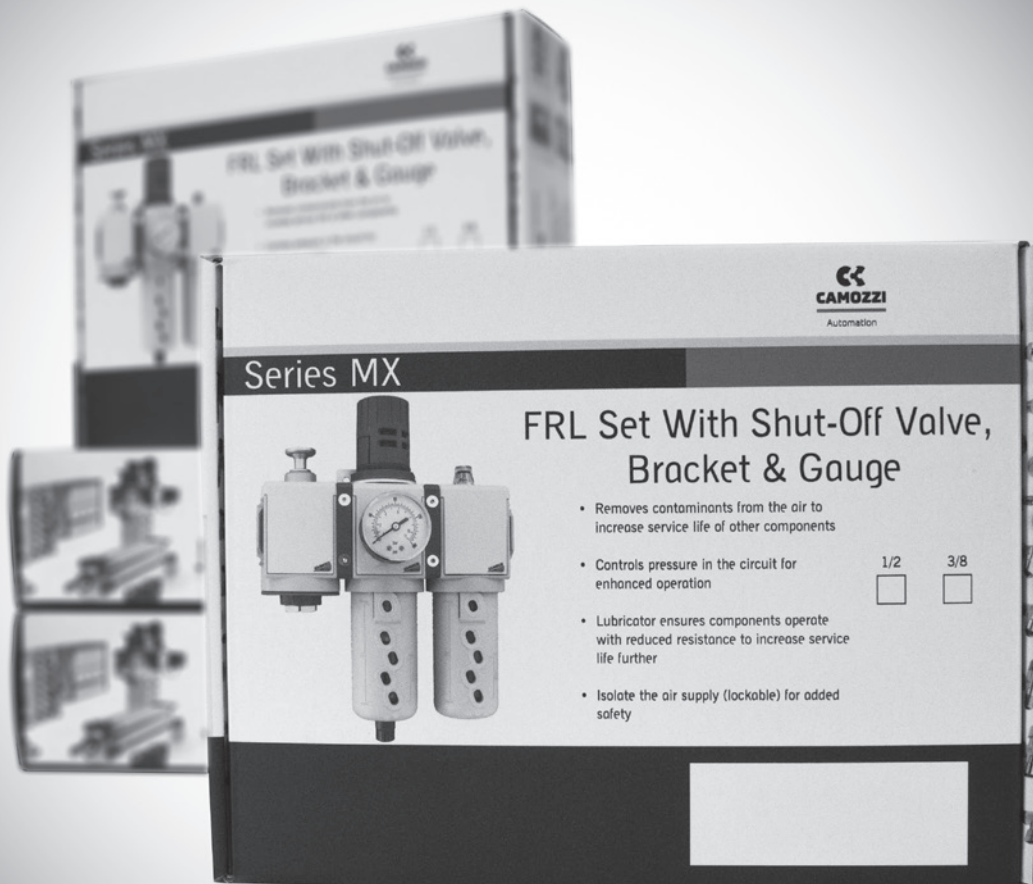

It's no secret that compressed air can be an expensive resource and therefore airline systems need to be protected from further, unnecessary costs. Without air treatment, compressors will push contaminants into airlines. The new box sets from Camozzi efficiently remove these contaminants to keep airline systems running smoothly.

Our pre-assembled air treatment units can be fitted straight from the box, thereby helping to reduce installation time further. Multiple ongoing maintenance tasks can also be completed with speed.

Camozzi's air treatment units are also packed full of safety features. The filter-regulator is tamper-proof as standard and both bowls employ locking systems to reduce any accident risk.

1/2 & 3/8

Removes Contaminants

Controls Pressure

Extends Component Service Life

Increased Safety

Pneumatic Connection

1 Super-Rapid Fittings

	Page
 <p>Series 6000 Brass Super-Rapid Fittings For Plastic Tubes</p>	254
 <p>Series 7000 Super-Rapid Compact Fittings in Technopolymer</p>	260
 <p>Series 8000 Brass Dual Seal Super-Rapid Fittings</p>	263
 <p>Series H8000 Nickel-Plated Dual Seal Super-Rapid Fitting</p>	264
 <p>Series X6000 Super-Rapid Fittings In Stainless Steel 316L</p>	265



2 Rapid Fittings

	Page
 <p>Series 1000 Brass Rapid Push-On Fittings For Plastic Tubes</p>	266

3 Compression Fittings

	Page
 <p>Series 1000 Brass Compression Fittings</p>	270



4 Fittings Accessories

	Page
 <p>Series S2000 Brass Pipe Fittings Sprint®</p>	271
 <p>Series 2000 Brass Pipe Fittings</p>	272

 <p>Brass Hose Tails and Connectors</p>	275
--	-----

 <p>Aluminium Distribution Manifold Blocks</p>	276
--	-----

5 Quick-Release Couplings

	Page
 <p>Series 5000 Quick-Release Couplings</p>	277
 <p>Series 5000L, 5000LT Quick-Release Couplings for the Conditioning of Moulds for Plastics</p>	278

6 Air Brake Fittings

 <p>Series 9000 C-Truck Air Brake Fittings</p>	279
---	-----

7 Tube Cutters and Accessories

	Page
 <p>Series PNZ, DRK</p>	283

Technical Data

Media
Push-in Compressed air (brass and technopolymer). Compressed air and water (stainless steel)
Dual Seal Compressed air and any fluids compatible with the materials specified requiring a leak tight seal
Push-on, Compression, Pipe Fittings and Quick Release Couplings Compressed air and other low pressure fluids
C-Truck Compressed air

Tube Options
Push-in Nylon 6, 11, 12, polyurethane, polyethylene and Hytrel polyester
Push-on As push-in + PVC braided
Dual Seal Nylon 6, 11, 12, polyurethane and Hytrel polyester
Compression Nylon 6, 11, 12 with insert 1320 and annealed copper
Quick Release Couplings Nylon, polyurethane, polyethylene, PVC and rubber hose
C-Truck Polyamide (D/d) 4/2, 6/4, 8/6, 10/8, 12/9, 15/12, 16/13 and 18/14

See individual product pages for operating pressures and temperatures.

Additional Options

Vacuum: All Camozzi fittings and Quick Release Couplings are suitable for vacuum applications. Check with Camozzi sales office for further information.

Viton O-rings: Available for most products on request

NPT versions: Available for most products on request

Special Requests

We offer a comprehensive design service to cater for all your special needs. If you cannot find what you need in our catalogue or you have a special request contact the Camozzi sales office with details of your enquiry.

Assembly Notes for Push-in Fittings

Tube ends should be cut square and be free from scoring or burrs.

The tube should be pushed through the collet and into the fitting until the tube end bottoms out.

To release tube, ensure there is no air present and push the collet ring towards the body of the fitting and withdraw the tube.

Materials
Push-in Body: Nickel-plated brass (Series 6000) Technopolymer (Series 7000) Stainless steel 316L (Series X6000)
Push-in Collets: Nickel-plated brass (Series 6000) Nickel-plated brass (Series 7000)
Collet and Body O-rings: NBR (Series 6000) NBR (Series 7000)
Thread Seal: PTFE, NBR, Nylon (Series 6000) NBR (Series 7000) FKM (Series X6000)
Push-on Body: Nickel-plated brass (Series 1000) Body O-rings: NBR Thread Seal: PTFE, Nylon, AL
Dual Seal Push-on Body and gripper: Nickel-plated brass Seals: NBR
Compression Nickel-plated brass
Pipe Fittings Body: Nickel-plated brass or 316 (CF8M) Stainless Steel Thread Seal: PTFE (Series S2000)
Quick-Release Couplings Body: Nickel-plated brass (hardened galvanised steel only for couplings with a '8' as the third number in the code) Seals: NBR
C-Truck Body and collet: Brass Locking nut: brass / zinc-plated steel Insert: brass / technopolymer Seals and protective cap: NBR

Assembly Notes for Compression Fittings

Tube ends should be cut square and concentric. Pass tube through tube nut and into olive.

Position olive so that it is square against the conical face of the body of the fitting.

Run nut onto thread and tighten carefully until olive "bites" onto surface of tube. Do not over tighten as this may result in tube being crushed and the flow being restricted.

The use of a tube insert is recommended for plastic tubes.

Assembly Notes for Push-on Fittings

Tube ends should be cut square and be free from scoring or burrs.

Slide nut over tube.

Push the tube onto the nipple until the end reaches the shoulder on the body of the fitting.

Screw nut onto thread until finger tight. For additional security, use spanner to tighten through a quarter turn. Do not over tighten.

Note:

Sprint fittings suitable for use in taper applications

NPT versions available for most products on request.

Series 6000 Brass Nickel Plated Super-Rapid Fittings For Plastic Tubes

Tube external diameters: 3, 4, 5, 6, 8, 10, 12, 14, 16 mm

Threaded connections: metric (M3, M5, M6, M7), BSP (1/8, 1/4, 3/8, 1/2, 3/4), BSPT (1/8, 1/4, 3/8, 1/2)

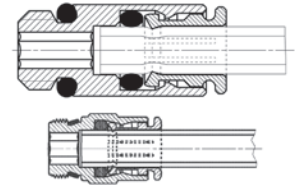

Operating pressure: min -0.9 bar - max 16 bar (see data for tubing used). Models with Self Retaining Device: min 0 bar - max 16 bar
 Operating temperature: Series 6000 Micro: -10°C - +80°C. Series 6000: -20°C - +80°C (see data for tubing used)

Connection and disconnection of the tube can be repeated several times and can be performed without the use of tools.

The extractable internal collet allows the sealing ring (O-ring) to be easily replaced if it is damaged or in case of wear of the rubber compound. Full data sheets and dimensions available at <https://store.camozzi.co.uk>

Sprint*



Male Connector	
S6510 4-1/8	✓
S6510 4-1/4	✓
S6510 5-1/8	✓
S6510 5-1/4	✓
S6510 6-1/8	✓
S6510 6-1/4	✓
S6510 6-3/8	✓
S6510 8-1/8	✓
S6510 8-1/4	✓
S6510 8-3/8	✓
S6510 8-1/2	✓
S6510 10-1/4	✓
S6510 10-3/8	✓
S6510 10-1/2	✓
S6510 12-1/4	✓
S6510 12-3/8	✓
S6510 12-1/2	✓
S6510 14-3/8	✓
S6510 14-1/2	✓
S6510 16-1/2	✓
S6510 16-3/4	✓

Sprint*



BSP Male Connector with Self Retaining Device	
S6510 4-1/8-LF	✓
S6510 6-1/8-LF	✓



BSP Male Connector	
6512 3-M3 ⁰	✓
6512 3-M5*	✓
6512 4-M7-M*	✓
6512 4-1/8-M*Y	✓
6512 6-M7-M*	✓
6512 6-1/8-M*Y	✓
6512 8-1/8-M*Y	✓
6512 10-1/4-M*	✓

⁰ = with mod. 2661 assembled
 * = with O-ring assembled
 *Y = with O-ring assembled
 It can be connected also to valve islands Series Y



Note: with O-Ring

BSP Male Connector	
6512 4-M5	✓
6512 4-M6	✓
6512 4-1/8	✓
6512 4-1/4	✓
6512 5-M5	✓
6512 6-M5	✓
6512 6-M6	✓
6512 6-1/8	✓
6512 6-1/4	✓
6512 8-1/8	✓
6512 8-1/4	✓
6512 8-3/8	✓
6512 10-1/4	✓
6512 10-3/8	✓
6512 10-1/2	✓
6512 12-1/4	✓
6512 12-3/8	✓
6512 12-1/2	✓
6512 14-3/8	✓
6512 14-1/2	✓
6512 16-1/2	✓

PNEUMATIC CONNECTION



BSP Female Connector	
6463 4-M5	✓
6463 4-1/8	✓
6463 5-1/8	✓
6463 6-1/8	✓
6463 6-1/4	✓
6463 8-1/8	✓
6463 8-1/4	✓
6463 10-1/4	✓



Swivel Male Elbow	
S6520 4-1/8	✓
S6520 4-1/4	✓
S6520 5-1/8	✓
S6520 5-1/4	✓
S6520 6-1/8	✓
S6520 6-1/4	✓
S6520 6-3/8	✓
S6520 8-1/8	✓
S6520 8-1/4	✓
S6520 8-3/8	✓
S6520 8-1/2	✓
S6520 10-1/4	✓
S6520 10-3/8	✓
S6520 10-1/2	✓
S6520 12-1/4	✓
S6520 12-3/8	✓
S6520 12-1/2	✓
S6520 14-3/8	✓
S6520 14-1/2	✓



BSP Swivel Male Elbow	
6522 3-M3 ⁰	✓
6522 3-M5*	✓

Swivel elbow
⁰ = with mod. 2661 assembled
 * = with O-ring assembled



Note: with O-Ring

BSP Swivel Male Elbow	
6522 4-M5	✓
6522 4-1/8	✓
6522 4-1/4	✓
6522 5-M5	✓
6522 6-M5	✓
6522 6-1/8	✓
6522 6-1/4	✓
6522 8-1/8	✓
6522 8-1/4	✓
6522 8-3/8	✓
6522 10-1/4	✓
6522 10-3/8	✓
6522 10-1/2	✓
6522 12-1/4	✓
6522 12-3/8	✓
6522 12-1/2	✓
6522 14-3/8	✓
6522 14-1/2	✓

Availability

- ✓ Ex Stock
- 🔧 UK Assembly
- 📞 Please Call Sales Office

Series 6000 Super-Rapid Fittings For Plastic Tubes

Availability

- ✓ Ex Stock
- 🔧 UK Assembly
- 📞 Please Call Sales Office

Sprint®



Fixed Male Elbow	
S6500 4-1/8	✓
S6500 4-1/4	✓
S6500 5-1/8	✓
S6500 5-1/4	✓
S6500 6-1/8	✓
S6500 6-1/4	✓
S6500 8-1/8	✓
S6500 8-1/4	✓
S6500 8-3/8	✓
S6500 10-1/4	✓
S6500 10-3/8	✓
S6500 12-1/4	✓
S6500 12-3/8	✓

Sprint®



Long Swivel Male Elbow	
6525 6 -1/8	✓
6525 6 -1/4	✓
6525 8 -1/8	✓
6525 8 -1/4	✓



BSP Adjustable Single Banjo	
6621 3 -M3	✓
6621 3 -M5	✓
Adjustable with mod. 2661 assembled	



BSP Fix Male Elbow	
6501 4 -M5	✓
With mod. 2661 assembled	

Sprint®



Swivel Male Tee	
S6430 4-1/8	✓
S6430 5-1/8	✓
S6430 5-1/4	✓
S6430 6-1/8	✓
S6430 6-1/4	✓
S6430 8-1/8	✓
S6430 8-1/4	✓
S6430 8-3/8	✓
S6430 10-1/4	✓
S6430 10-3/8	✓
S6430 10-1/2	✓
S6430 12-1/4	✓
S6430 12-3/8	✓
S6430 12-1/2	✓
S6430 14-1/2	✓



BSP Swivel Male Tee	
6432 3 -M3 ^o	✓
6432 3 -M5*	✓
^o = with mod. 2661 assembled	
* = with O-ring assembled	



BSP Swivel Male Tee	
6432 4 -M5	✓
6432 4 -1/8	✓
6432 5 -M5	✓
6432 6 -1/8	✓
6432 6 -1/4	✓
6432 8 -1/8	✓
6432 8 -1/4	✓
6432 8 -3/8	✓
6432 10-1/4	✓
6432 10-3/8	✓
6432 12-1/4	✓
6432 12-3/8	✓

Sprint®



Lateral Swivel Male Tee	
S6440 4-1/8	✓
S6440 5-1/8	✓
S6440 6-1/8	✓
S6440 6-1/4	✓
S6440 8-1/8	✓
S6440 8-1/4	✓
S6440 8-3/8	✓
S6440 10-1/4	✓
S6440 10-3/8	✓
S6440 12-3/8	✓
S6440 14-1/2	✓

Series 6000 Super-Rapid Fittings For Plastic Tubes

Availability

- ✓ Ex Stock
- 🔧 UK Assembly
- 📞 Please Call Sales Office



Lateral BSP Swivel Male Tee	
6442 3-M3 ^o	✓
6442 3-M5*	✓

^o = with mod. 2661 assembled
* = with O-ring assembled

Note:
with O-Ring

Lateral BSP Swivel Male Tee	
6442 4 -M5	✓
6442 4 -1/8	✓
6442 5 -M5	✓
6442 6 -1/8	✓
6442 6 -1/4	✓
6442 8 -1/8	✓
6442 8 -1/4	✓
6442 8 -3/8	✓
6442 10-1/4	✓
6442 10-3/8	✓
6442 12-1/4	✓
6442 12-3/8	✓

BSP Swivel Male Y	
6452 3 -M3 ^o	✓
6452 3 -M5*	✓

^o = with gasket
* = with O-ring

BSP Male Y	
6451 4 -M5*	✓
6451 6 -M5*	✓

Swivel Male Y	
S6450 4-1/8	✓
S6450 6-1/8	✓
S6450 8-1/8	✓
S6450 8-1/4	✓

* = non swivel model with gasket



Note:
with O-Ring

BSP Swivel Single Banjo	
6622 4 -M5	✓
6622 4 -1/8	✓
6622 6 -1/8	✓
6622 6 -1/4	✓
6622 8 -1/8	✓
6622 8 -1/4	✓
6622 10-1/4	✓

Note:
with O-Ring

BSP Swivel Double Banjo	
6632 4 -1/8	✓
6632 6 -1/8	✓
6632 6 -1/4	✓
6632 8 -1/8	✓
6632 8 -1/4	✓
6632 10-1/4	✓

Double Banjo	
6620 4 -M5 ^o	✓
6620 4-1/8*	✓
6620 6-1/8*	✓
6620 6-1/4*	✓
6620 8-1/8*	✓
6620 8-1/4*	✓

Banjo Bolts	
1631 01...	✓
1631 02...	✓
1631 03...	✓

01... = Single Banjo Stem
02... = Double Banjo Stem
03... = Triple Banjo Stem
See Page 268

Assembly with Mod.
^o = SCU, SVU, SCO...
* = 1631, 1635, SCU, SVU, SCO...
See Page 268

Series 6000 Super-Rapid Fittings For Plastic Tubes

Availability

- ✓ Ex Stock
- 🔧 UK Assembly
- 📞 Please Call Sales Office



Single Banjo	
6610 4 -M5°	✓
6610 4 -M6°	✓
6610 4-1/8*	✓
6610 5 -M5°	✓
6610 5 -M6°	✓
6610 5-1/8*	✓
6610 6 -M5°	✓
6610 6 -M6°	✓
6610 6-1/8*	✓
6610 6-1/4*	✓
6610 8-1/8*	✓
6610 8-1/4*	✓
6610 8-3/8*	✓
6610 10-1/4**	✓
6610 10-3/8**	✓
6610 12-1/2^	✓

Assembly with Mod.

- ° = 1631
- ° = SCU, SVU, SCO...
- * = 1631, 1635, SCU, SVU, SCO...
- ** = 1635, SCU, SVU, SCO...
- ^ = 1635

Sprint®



*Note:
with O-Ring

Male Adaptor	
6811 4 -M5*	✓
6811 4 -1/8	✓
6811 5 -1/8	✓
6811 5 -1/4	✓
6811 6 -1/8	✓
6811 6 -1/4	✓
6811 8 -1/8	✓
6811 8 -1/4	✓
6811 10-1/4	✓
6811 10-3/8	✓
6811 12-3/8	✓
6811 14-1/2	✓

Sprint®



45° Male Elbow	
S6110 6-1/8	✓
S6110 6-1/4	✓
S6110 8-1/8	✓
S6110 8-1/4	✓
S6110 8-3/8	✓
S6110 10-1/4	✓
S6110 10-3/8	✓
S6110 10-1/2	✓
S6110 12-1/4	✓
S6110 12-3/8	✓
S6110 12-1/2	✓



Bulkhead Connector	
6590 3	✓



Bulkhead Connector	
6590 4	✓
6590 5	✓
6590 6	✓
6590 8	✓
6590 10	✓
6590 12	✓
6590 14	✓



Union Connector	
6580 3	✓



Union Connector	
6580 4	✓
6580 5	✓
6580 6	✓
6580 8	✓
6580 10	✓
6580 12	✓
6580 14	✓
6580 16	✓



Reducer Union Connector	
6580 6-4	✓
6580 8-6	✓
6580 10-8	✓
6580 12-10	✓



BSP Female Bulkhead	
6593 6-1/8	✓
6593 6-1/4	✓
6593 8-1/8	✓
6593 8-1/4	✓
6593 10-3/8	✓



Elbow Connector	
6550 3	✓



Elbow Connector	
6550 4	✓
6550 5	✓
6550 6	✓
6550 8	✓
6550 10	✓
6550 12	✓
6550 14	✓



Tee Connector	
6540 3	✓

Series 6000 Super-Rapid Fittings For Plastic Tubes

Availability

- ✓ Ex Stock
- 🔧 UK Assembly
- 📞 Please Call Sales Office



Tee Connector		
6540	4	✓
6540	5	✓
6540	6	✓
6540	8	✓
6540	10	✓
6540	12	✓
6540	14	✓



Cross Junction		
6600	4	✓
6600	5	✓
6600	6	✓
6600	8	✓
6600	10	✓
6600	12	✓



Y Union		
6560	3	✓



Y Union		
6560	4	✓
6560	6	✓
6560	8	✓
6560	10	✓



Cartridge		
6700	3	✓



Press Fit Cartridge		
6700	4	✓
6700	5	✓
6700	6	✓
6700	8	✓
6700	10	✓



Female Plug		
6750	4	✓
6750	6	✓
6750	8	✓
6750	10	✓
6750	12	✓



Enlarger Junction		
6850	6-4	✓
6850	8-6	✓



Reducer Junction		
6800	3-4	✓



Reducer Junction		
6800	4-5	✓
6800	4-6	✓
6800	4-8	✓
6800	5-6	✓
6800	5-8	✓
6800	6-8	✓
6800	6-10	✓
6800	6-12	✓
6800	8-10	✓
6800	8-12	✓
6800	10-12	✓
6800	10-14	✓
6800	12-14	✓



Junction		
6950	4	✓
6950	6	✓
6950	8	✓
6950	10	✓
6950	12	✓
6950	14	✓



Junction Elbow		
6555	4-4	✓
6555	6-6	✓
6555	8-8	✓
6555	10-10	✓

Series 6000 Super-Rapid Fittings For Plastic Tubes

Availability

- ✓ Ex Stock
- 🔧 UK Assembly
- 📞 Please Call Sales Office



Protection Cap	
6708 4	✓
6708 5	✓
6708 6	✓
6708 8	✓
6708 10	✓
6708 12	✓
6708 14	✓

Colour: Black
Self-extinguishing material,
class V0



Plastic Male Plug	
6900 3	✓



Plastic Male Plug	
6900 4	✓
6900 5	✓
6900 6	✓
6900 8	✓
6900 10	✓
6900 12	✓
6900 14	✓



The set includes keys to disconnect tubes with diameters between 4 and 12mm

Part Number	
SP	✓



For Tubing
From page 342



For Banjo Bolts
See Page 268

UK Online Store



Request an account today

- Instantly check price and availability
- Download product datasheets
- Place orders whenever it suits you

<https://store.camozzi.co.uk>



Series 7000 Super-Rapid Compact Fittings in Technopolymer

Tube external diameters: 4, 6, 8, 10, 12, 16mm

Connections: metric (M5, M7), BSP (1/8, 1/4, 3/8, 1/2, 3/4)

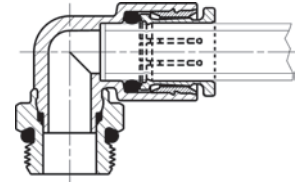

Operating pressure: min -0.9 bar - max 16 bar (see data for tubing used).

Models with Self Retaining Device: min 0 bar - max 16 bar

Operating temperature: -20°C - +60°C (see data for tubing used)

These models have been released in technopolymer, maintaining the same technical characteristics as the existing Camozzi fittings range.

Lightweight, adaptable and they allow for easy maintenance of the collet and the internal seal.

All materials, with the exception of the internal seals, can easily be recycled.

Full data sheets and dimensions available at <https://store.camozzi.co.uk>

Availability

- ✓ Ex Stock
- ✎ UK Assembly
- Ⓞ Please Call Sales Office



BSP Male Swivel Elbow	
7522 4-M5	✓
7522 4-M7	✓
7522 4-1/8	✓
7522 4-1/4	✓
7522 6-M5	✓
7522 6-M7	✓
7522 6-1/8	✓
7522 6-1/4	✓
7522 8-1/8	✓
7522 8-1/4	✓
7522 8-3/8	✓
7522 10-1/4	✓
7522 10-3/8	✓
7522 10-1/2	✓
7522 12-1/4	✓
7522 12-3/8	✓
7522 12-1/2	✓
7522 16-1/2	✓
7522 16-3/4	✓



Long BSP Swivel Elbow Self Retaining	
7522 4-1/8-LF	✓
7522 6-1/8-LF	✓



Long BSP Swivel Elbow	
7526 4-M7	✓
7526 4-1/8	✓
7526 6-M7	✓
7526 6-1/8	✓
7526 6-1/4	✓
7526 8-1/8	✓
7526 8-1/4	✓



Lateral BSP Swivel Male Tee	
7442 4-1/8	✓
7442 6-1/8	✓
7442 6-1/4	✓
7442 8-1/8	✓
7442 8-1/4	✓
7442 8-3/8	✓
7442 10-1/4	✓
7442 10-3/8	✓
7442 12-3/8	✓
7442 12-1/2	✓
7442 16-1/2*	✓
7442 16-3/4*	✓

*model without mounting holes



BSP Swivel Male Multi Tee Reducer	
7542 6-4-1/8	✓
7542 6-4-1/4	✓
7542 8-6-1/8	✓
7542 8-6-1/4	✓
7542 10-8-1/4	✓
7542 10-8-3/8	✓



BSP Swivel Male Tee	
7432 4-M5	✓
7432 4-1/8	✓
7432 6-M5	✓
7432 6-1/8	✓
7432 6-1/4	✓
7432 8-1/8	✓
7432 8-1/4	✓
7432 8-3/8	✓
7432 10-1/4	✓
7432 10-3/8	✓
7432 12-1/4	✓
7432 12-3/8	✓
7432 12-1/2	✓
7432 16-1/2	✓
7432 16-3/4	✓



BSP Swivel Male Y	
7562 4-1/8	✓
7562 6-1/8	✓
7562 6-1/4	✓
7562 8-1/8	✓
7562 8-1/4	✓
7562 10-1/4	✓
7562 10-3/8	✓



BSP Swivel Male Double Y	
7572 4-1/8	✓
7572 4-1/4	✓
7572 6-1/8	✓
7572 6-1/4	✓

Series 7000 Super-Rapid Compact Fittings in Technopolymer

Availability

- ✓ Ex Stock
- 🔧 UK Assembly
- 📞 Please Call Sales Office



BSP Swivel Single Banjo	
7622 4-1/8	✓
7622 6-1/8	✓
7622 6-1/4	✓
7622 8-1/8	✓
7622 8-1/4	✓
7622 10-1/4	✓
7622 10-3/8	✓
7622 12-3/8	✓



BSP Swivel Double Banjo	
7652 4-1/8	✓
7652 6-1/8	✓
7652 6-1/4	✓
7652 8-1/8	✓
7652 8-1/4	✓
7652 10-1/4	✓
7652 10-3/8	✓



Single Banjo	
7610 4-1/8	✓
7610 6-1/8	✓
7610 6-1/4	✓
7610 8-1/8	✓
7610 8-1/4	✓
7610 10-1/4	✓
7610 10-3/8	✓
7610 12-3/8	✓



Double Banjo	
7640 4-1/8	✓
7640 6-1/8	✓
7640 6-1/4	✓
7640 8-1/8	✓
7640 8-1/4	✓
7640 10-1/4	✓

Assembly with
Mod. 7632 02, 7632 03



Double Banjo Stem	
7632 02-1/8	✓
7632 02-1/4	✓
7632 02-3/8	✓

Assembly with adjustable fittings Mod. 7610, 7640



Triple Banjo Stem	
7632 03-1/8	✓
7632 03-1/4	✓

Assembly with adjustable fittings Mod. 7610, 7640



BSP Double Adjustable Single Banjo	
7612 02-4-1/8	✓
7612 02-6-1/8	✓
7612 02-6-1/4	✓
7612 02-8-1/8	✓
7612 02-8-1/4	✓
7612 02-10-1/4	✓
7612 02-10-3/8	✓
7612 02-12-3/8	✓



BSP Triple Adjustable Single Banjo	
7612 03-4-1/8	✓
7612 03-6-1/8	✓
7612 03-6-1/4	✓
7612 03-8-1/8	✓
7612 03-8-1/4	✓
7612 03-10-1/4	✓



BSP Double Adjustable Double Banjo	
7642 02-4-1/8	✓
7642 02-6-1/8	✓
7642 02-6-1/4	✓
7642 02-8-1/8	✓
7642 02-8-1/4	✓
7642 02-10-1/4	✓



BSP Triple Adjustable Double Banjo	
7642 03-4-1/8	✓
7642 03-6-1/8	✓
7642 03-6-1/4	✓
7642 03-8-1/8	✓
7642 03-8-1/4	✓
7642 03-10-1/4	✓



Reducer Junction	
7800 4-6	✓
7800 4-8	✓
7800 6-8	✓
7800 6-10	✓
7800 6-12	✓
7800 8-10	✓
7800 8-12	✓
7800 10-12	✓
7800 10-14	✓



Junction Elbow	
7555 4-4	✓
7555 6-6	✓
7555 8-8	✓
7555 10-10	✓
7555 12-12	✓

Series 7000 Super-Rapid Compact Fittings in Technopolymer

Availability

- ✓ Ex Stock
- 🔧 UK Assembly
- 📞 Please Call Sales Office



Union Connector	
7580 4	✓
7580 6	✓
7580 8	✓
7580 10	✓
7580 12	✓



Elbow Connector	
7550 4	✓
7550 6	✓
7550 8	✓
7550 10	✓
7550 12	✓
7550 16*	✓

* = model without mounting holes



Tee Connector	
7540 4	✓
7540 6	✓
7540 8	✓
7540 10	✓
7540 12	✓
7540 16*	✓

* = model without mounting holes



Multi Tee Reducer	
7545 6-4	✓
7545 8-6	✓
7545 10-8	✓



Y Connector Reducer	
7560 4	✓
7560 6	✓
7560 8	✓
7560 10	✓
7560 6-4	✓
7560 8-6	✓
7560 10-8	✓



Double Y Reducer	
7575 6-4	✓
7575 8-6	✓



Plastic Junction	
7950 4	✓
7950 6	✓
7950 8	✓
7950 10	✓
7950 12	✓



For Super-Rapid Fittings
See 254-259



For Tubing
From page 342

Series 8000 Brass Nickel Plated Dual Seal Push-In Fittings

Tube external diameters: 4 - 6 - 8 - 10 and 12mm

Connections: BSP (1/8, 1/4, 3/8, 1/2)

Operating pressure: min -0.9 bar to max 60 bar (see data for tubing used)

Operating temperature: -20°C - +80°C

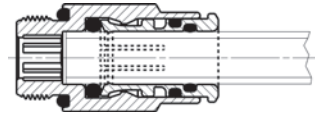

The Camozzi range of dual seal super rapid push in fittings are designed to assist with the assembly of high pressure fluid systems up to 60 bar.

For technical specifications and assembly notes see page 253

Full data sheets and dimensions available at <https://store.camozzi.co.uk>

Availability

- ✓ Ex Stock
- 🔧 UK Assembly
- 📞 Please Call Sales Office

PNEUMATIC CONNECTION



Note:
with O-Ring

BSP Male Connector	
8512 4 -1/8	📞
8512 6 -1/8	📞
8512 6 -1/4	📞
8512 8 -1/8	📞
8512 8 -1/4	📞
8512 10-1/4	📞
8512 10-3/8	📞
8512 12-3/8	📞
8512 12-1/2	📞



Note:
with O-Ring

BSP Swivel Male Elbow	
8522 4 -1/8	📞
8522 6 -1/8	📞
8522 6 -1/4	📞
8522 8 -1/8	📞
8522 8 -1/4	📞
8522 10-1/4	📞
8522 10-3/8	📞
8522 12-3/8	📞
8522 12-1/2	📞



Note:
with O-Ring

BSP Swivel Male Tee	
8432 4 -1/8	📞
8432 6 -1/8	📞
8432 8 -1/8	📞
8432 8 -1/4	📞



Union Connector	
8580 4	📞
8580 6	📞
8580 8	📞



Elbow Connector	
8550 4	📞
8550 6	📞
8550 8	📞



Tee Connector	
8540 4	📞
8540 6	📞
8540 8	📞



For Tubing
From page 342

Series H8000 Brass Nickel Plated Dual Seal Super-Rapid Fittings

Tube external diameters: 4 - 6 - 8 - 10 - 12mm

Fitting threads: BSP (1/8, 1/4, 3/8, 1/2)

Working pressure: min -0.9 bar to max 60 bar

Operating temperature: With FKM seals (standard): -15°C - +200°C (dry air)

With EPDM (upon request): -40°C - 110°C

With NBR seals (upon request): -20°C - 80°C

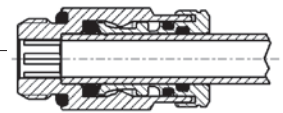

Series H8000 fittings are designed to be used in particularly dirty and dusty working environments. The patented system with double tightening on the tube guarantees a highly reliable connection and avoids any risk of leakage. Full data sheets and dimensions available at <https://store.camozzi.co.uk>

Availability

- ✓ Ex Stock
- 🔧 UK Assembly
- 📞 Please Call Sales Office



BSP Male Connector	
H8512 4-1/8-V	🕒
H8512 6-1/8-V	🕒
H8512 6-1/4-V	🕒
H8512 8-1/8-V	🕒
H8512 8-1/4-V	🕒
H8512 8-3/8-V	🕒
H8512 10-1/8-V	🕒
H8512 10-1/4-V	🕒
H8512 10-3/8-V	🕒
H8512 10-1/2-V	🕒
H8512 12-1/4-V	🕒
H8512 12-3/8-V	🕒
H8512 12-1/2-V	🕒



BSP Swivel Male Elbow	
H8522 4-1/8-V	🕒
H8522 6-1/8-V	🕒
H8522 6-1/4-V	🕒
H8522 8-1/8-V	🕒
H8522 8-1/4-V	🕒
H8522 8-3/8-V	🕒
H8522 10-1/8-V	🕒
H8522 10-1/4-V	🕒
H8522 10-3/8-V	🕒
H8522 10-1/2-V	🕒
H8522 12-1/4-V	🕒
H8522 12-3/8-V	🕒
H8522 12-1/2-V	🕒



Union Connector	
H8580 4-V	🕒
H8580 6-V	🕒
H8580 8-V	🕒
H8580 10-V	🕒
H8580 12-V	🕒



Union Connector	
H8540 4-V	🕒
H8540 6-V	🕒
H8540 8-V	🕒
H8540 10-V	🕒
H8540 12-V	🕒



Elbow Connector	
H8550 4-V	🕒
H8550 6-V	🕒
H8550 8-V	🕒
H8550 10-V	🕒
H8550 12-V	🕒

Series X6000 Super-Rapid Fittings in 316L Stainless Steel

Tube external diameters: 4, 6, 8, 10, 12mm

Fittings threads: BSP (1/8, 1/4, 3/8, 1/2)

BSPT (1/8, 1/4, 3/8, 1/2)

Operating pressure: max 18 bar (see data for tubing used)

Operating temperature: -15°C - +150°C (see data for tubing used)

Series X6000 fittings in Stainless Steel 316L allow the connection of fluids even in aggressive environments.

They are suitable for applications in the pneumatics, fluids, chemical, medical, food and packaging industries.

Full data sheets and dimensions available at <https://store.camozzi.co.uk>

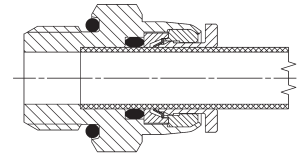

PNEUMATIC CONNECTION

Availability

- ✓ Ex Stock
- ✎ UK Assembly
- 📞 Please Call Sales Office



BSPT Male Connector	
X6510 4-1/8	☉
X6510 4-1/4	☉
X6510 6-1/8	☉
X6510 6-1/4	☉
X6510 8-1/8	☉
X6510 8-1/4	☉
X6510 10 -1/4	☉
X6510 10 -3/8	☉
X6510 10 -1/2	☉
X6510 12 -1/4	☉
X6510 12 -3/8	☉
X6510 12 -1/2	☉

BSP Male Connector	
X6512 4-1/8	☉
X6512 4-1/4	☉
X6512 6-1/8	☉
X6512 6-1/4	☉
X6512 8-1/8	☉
X6512 8-1/4	☉
X6512 10-1/4	☉
X6512 10-3/8	☉
X6512 10-1/2	☉
X6512 12-1/4	☉
X6512 12-3/8	☉
X6512 12-1/2	☉

BSPT Fix Elbow	
X6500 4-1/8	☉
X6500 6-1/8	☉
X6500 6-1/4	☉
X6500 8-1/8	☉
X6500 8-1/4	☉
X6500 10-1/4	☉
X6500 10-3/8	☉
X6500 12-1/4	☉
X6500 12-3/8	☉

BSPT Swivel Male Elbow	
X6520 4-1/8	☉
X6520 4-1/4	☉
X6520 6-1/8	☉
X6520 6-1/4	☉
X6520 8-1/8	☉
X6520 8-1/4	☉
X6520 10-1/4	☉
X6520 10-3/8	☉
X6520 12-1/4	☉
X6520 12-3/8	☉
X6520 12-1/2	☉



BSPT Swivel Male Tee	
X6430 4-1/8	☉
X6430 4-1/4	☉
X6430 6-1/8	☉
X6430 6-1/4	☉
X6430 8-1/8	☉
X6430 8-1/4	☉
X6430 10 -1/4	☉
X6430 10 -3/8	☉
X6430 12 -1/4	☉
X6430 12 -3/8	☉
X6430 12 -1/2	☉

BSP Swivel Male Elbow	
X6522 4-1/8	☉
X6522 4-1/4	☉
X6522 6-1/8	☉
X6522 6-1/4	☉
X6522 8-1/8	☉
X6522 8-1/4	☉
X6522 10 -1/4	☉
X6522 10 -3/8	☉
X6522 12 -1/4	☉
X6522 12 -3/8	☉
X6522 12 -1/2	☉

BSP Swivel Male Tee	
X6432 4-1/8	☉
X6432 4-1/4	☉
X6432 6-1/8	☉
X6432 6-1/4	☉
X6432 8-1/8	☉
X6432 8-1/4	☉
X6432 10 -1/4	☉
X6432 10 -3/8	☉
X6432 12 -1/4	☉
X6432 12 -3/8	☉
X6432 12 -1/2	☉

Union Connector	
X6580 4	☉
X6580 6	☉
X6580 8	☉
X6580 10	☉
X6580 12	☉

Series X6000 Super-rapid Fittings

Availability

- ✓ Ex Stock
- 🔧 UK Assembly
- 📞 Please Call Sales Office



Elbow Connector	
X6550 4	📞
X6550 6	📞
X6550 8	📞
X6550 10	📞
X6550 12	📞

Tee Connector	
X6540 4	📞
X6540 6	📞
X6540 8	📞
X6540 10	📞
X6540 12	📞

Bulkhead Connector	
X6590 4	📞
X6590 6	📞
X6590 8	📞
X6590 10	📞
X6590 12	📞

Reducer Tube/Stem	
X6800 4-6	📞
X6800 4-8	📞
X6800 6-8	📞
X6800 6-10	📞
X6800 6-12	📞
X6800 8-10	📞
X6800 8-12	📞
X6800 10-12	📞

Series 1000 Brass Nickel Plated Rapid Push-On Fittings For Plastic Tubes

Tube external diameters: 5/3, 6/4, 8/6, 10/8, 12/10, 15/12.5mm
 Connections: metric (M5, M6, M12x1, M12x1.25), BSP (1/8, 1/4, 3/8, 1/2), BSPT (1/8, 1/4, 3/8, 1/2)

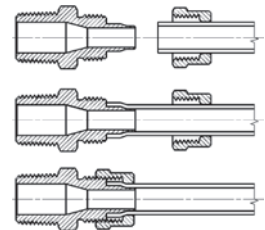

Operating pressure: the nominal pressure of the fittings is always higher than the pressure of the tube.
 Operating temperature: -20°C - +80°C (see data for tubing used).

The Camozzi range of rapid push-on fittings are designed to assist with the assembly of fluid power components and systems.

For technical specifications and assembly notes see page 253

Full data sheets and dimensions available at <https://store.camozzi.co.uk>

Availability

- ✓ Ex Stock
- 🔧 UK Assembly
- 📞 Please Call Sales Office



Sprint*



BSPT Male Connector	
1510 5/3-1/8	✓
1510 6/4-1/8	✓
1510 6/4-1/4	✓
1510 6/4-3/8	✓
1510 6/4-1/2	✓
1510 6/4-M12x1.25	✓
1510 8/6-1/8	✓
1510 8/6-1/4	✓
1510 8/6-3/8	✓
1510 8/6-1/2	✓
1510 10/8-1/8	✓
1510 10/8-1/4	✓
1510 10/8-3/8	✓
1510 10/8-1/2	✓
1510 12/10-3/8	✓
1510 12/10-1/2	✓
1510 15/12.5-1/2	✓

Male Connector	
1511 5/3-M5*	✓
1511 5/3-M6*	✓
1511 5/3-1/8	✓
1511 6/4-M5*	✓
1511 6/4-M6*	✓
1511 6/4-1/8	✓
1511 6/4-1/4	✓
1511 6/4-3/8	✓
1511 8/6-1/8	✓
1511 8/6-1/4	✓
1511 8/6-3/8	✓
1511 10/8-1/8	✓
1511 10/8-1/4	✓
1511 10/8-3/8	✓
1511 10/8-1/2	✓
1511 12/10-3/8	✓
1511 12/10-1/2	✓
1511 15/12.5-1/2	✓

* With O-Ring assembled

Series 1000 Rapid Push-On Fittings For Plastic Tubes

Availability

- ✓ Ex Stock
- 🔧 UK Assembly
- 📞 Please Call Sales Office

Sprint®



Swivel Male Connector	
1560 6/4-1/8	✓
1560 6/4-1/4	✓
1560 8/6-1/8	✓
1560 8/6-1/4	✓
1560 10/8-1/4	✓
1560 10/8-3/8	✓
1560 12/10-3/8	✓



BSP Female Connector	
1463 5/3-1/8	✓
1463 6/4-1/8	✓
1463 6/4-1/4	✓
1463 6/4-3/8	✓
1463 8/6-1/8	✓
1463 8/6-1/4	✓
1463 8/6-3/8	✓
1463 10/8-1/8	✓
1463 10/8-1/4	✓
1463 10/8-3/8	✓
1463 10/8-1/2	✓
1463 12/10-3/8	✓

Sprint®



Swivel Male Elbow	
1541 6/4-1/8	✓
1541 6/4-1/4	✓
1541 8/6-1/8	✓
1541 8/6-1/4	✓
1541 10/8-1/4	✓



Fixed BSPT Male Elbow	
1500 5/3-1/8	✓
1500 6/4-1/8	✓
1500 6/4-1/4	✓
1500 6/4-3/8	✓
1500 6/4-M12x1.25	✓
1500 8/6-1/8	✓
1500 8/6-1/4	✓
1500 8/6-3/8	✓
1500 8/6-1/2	✓
1500 10/8-1/8	✓
1500 10/8-1/4	✓
1500 10/8-3/8	✓
1500 10/8-1/2	✓
1500 12/10-3/8	✓
1500 12/10-1/2	✓
1500 15/12.5-1/2	✓



Note: with 2661 Nylon Ring

Fixed BSP Male Elbow	
1501 5/3-M5	✓

Sprint®



BSP Female Elbow	
1493 6/4-1/8	✓
1493 6/4-1/4	✓
1493 8/6-1/8	✓
1493 8/6-1/4	✓
1493 10/8-1/4	✓
1493 12/10-3/8	✓



Swivel Male Tee	
1431 6/4-1/8	✓
1431 6/4-1/4	✓
1431 8/6-1/8	✓
1431 8/6-1/4	✓
1431 10/8-1/4	✓



BSPT Fixed Male Tee	
1410 5/3-1/8	✓
1410 6/4-1/8	✓
1410 6/4-1/4	✓
1410 8/6-1/8	✓
1410 8/6-1/4	✓
1410 10/8-1/8	✓
1410 10/8-1/4	✓
1410 10/8-3/8	✓
1410 10/8-1/2	✓
1410 12/10-3/8	✓
1410 12/10-1/2	✓
1410 15/12.5-1/2	✓



Lateral BSPT Male Tee	
1420 5/3-1/8	✓
1420 6/4-1/8	✓
1420 6/4-1/4	✓
1420 8/6-1/8	✓
1420 8/6-1/4	✓
1420 10/8-1/8	✓
1420 10/8-1/4	✓

Series 1000 Rapid Push-On Fittings For Plastic Tubes



Note: with 2661 Nylon Ring

BSP Single Adjustable Banjo	
1521 5/3-M5	✓
1521 5/3-1/8	✓
1521 6/4-M5	✓
1521 6/4-1/8	✓
1521 6/4-1/4	✓
1521 6/4-3/8	✓
1521 8/6-1/8	✓
1521 8/6-1/4	✓
1521 8/6-3/8	✓



Note: with 2661 Nylon Ring

Single Adjustable Long Banjo	
1525 6/4-1/8	✓
1525 6/4-1/4	✓
1525 6/4-3/8	✓
1525 8/6-1/8	✓
1525 8/6-1/4	✓
1525 8/6-3/8	✓
1525 10/8-1/8	✓
1525 10/8-1/4	✓
1525 10/8-3/8	✓
1525 10/8-1/2	✓
1525 12/10-3/8	✓
1525 12/10-1/2	✓
1525 15/12.5-1/2	✓



Single Banjo	
1610 5/3-M5°	✓
1610 5/3-M6°	✓
1610 5/3-1/8*	✓
1610 6/4-M5°	✓
1610 6/4-M6°	✓
1610 6/4-1/8*	✓
1610 6/4-1/4*	✓
1610 6/4-3/8*	✓
1610 8/6-1/8*	✓
1610 8/6-1/4*	✓
1610 8/6-3/8*	✓
1610 10/8-1/8**	✓
1610 10/8-1/4**	✓
1610 10/8-3/8**	✓
1610 10/8-1/2^	✓
1610 12/10-3/8*	✓
1610 12/10-1/2^	✓
1610 15/12.5-1/2^	✓

Assembly with Mod.

- ° = 1631, 1635
- ° = SCU, SVU, SCO...
- * = 1631, 1635, SCU, SVU, SCO...
- ** = 1635, SCU, SVU, SCO...
- ^ = 1635

Availability

- ✓ Ex Stock
- ✎ UK Assembly
- ☎ Please Call Sales Office



Double Banjo	
1620 6/4-M5°	✓
1620 6/4-1/8*	✓
1620 6/4-1/4*	✓
1620 8/6-1/8*	✓
1620 8/6-1/4*	✓

Assembly with Mod.
 ° = 1631, 1635
 * = 1631, 1635, SCU, SVU, SCO...



Assembled with adjustable fittings Mod. 6610, 6620, 1610, 1620, 1170, 2023

Single Banjo Stem	
1631 01-M5 - Zinc plated steel	
1631 01-1/8	✓
1631 01-1/4	✓
1631 01-3/8	✓
1631 01-1/2	✓



Assembled with adjustable fittings Mod. 6610, 6620, 1610, 1620, 1170, 2023

Double Banjo Stem	
1631 02-1/8	✓
1631 02-1/4	✓
1631 02-3/8	✓



Double Long banjo fittings Mod. 6610, 6620, 1610, 1620, 1170, 2023

Double Long Banjo Stem	
1635 02-1/8	✓
1635 02-1/4	✓
1635 02-3/8	✓
1635 02-1/2	✓



Assembled with adjustable fittings Mod. 6610, 6620, 1610, 1620, 1170, 2023

Triple Banjo Stem	
1631 03-1/8	✓
1631 03-1/4	✓
1631 03-3/8	✓



Assembled with adjustable fittings Mod. 6610, 6620, 1610, 1620, 1170, 2023

* = Models that can be assembled with 1/4 banjo fittings

Single Long Banjo Stem	
1635 01-1/8	✓
1635 01-1/4	✓
1635 01-3/8	✓
1635 01-1/2	✓
1635 01-M12x1.25*	✓
1635 01-M12x1.5*	✓

Series 1000 Rapid Push-On Fittings For Plastic Tubes

Availability

- ✓ Ex Stock
- 🔧 UK Assembly
- 📞 Please Call Sales Office



Union Connector	
1580 5/3	✓
1580 6/4	✓
1580 8/6-6/4	✓
1580 8/6	✓
1580 10/8-6/4	✓
1580 10/8	✓
1580 12/10	✓
1580 15/12.5	✓



Bulkhead Union	
1590 5/3	✓
1590 6/4-5/3	✓
1590 6/4	✓
1590 8/6-6/4	✓
1590 8/6	✓
1590 10/8	✓
1590 12/10	✓



Elbow Connector	
1550 6/4	✓
1550 8/6	✓
1550 10/8	✓
1550 12/10	✓
1550 15/12.5	✓



Tee Connector	
1540 5/3	✓
1540 6/4	✓
1540 8/6-6/4	✓
1540 8/6	✓
1540 10/8-6/4	✓
1540 10/8-8/6	✓
1540 10/8	✓
1540 12/10	✓
1540 15/12.5	✓



Cross Connector	
1600 6/4	✓
1600 8/6	✓



Adaptor with Junction	
1470 6/4-6	✓
1470 8/6-8	✓



Aluminium Washer	
2651 1/8	✓
2651 1/4	✓
2651 3/8	✓
2651 1/2	✓
2651 1	✓



Plastic Washer	
2665 1/8	✓
2665 1/4	✓
2665 3/8	✓
2665 1/2	✓



Blocking Nut	
1703 5/3-M7x0.75	✓
1703 6/4-M8x0.75	✓
1703 6/4-M10x1	✓
1703 8/6-M12x1	✓
1703 10/8-M14x1	✓
1703 12/10-M16x1	✓
1703 15/12.5-M20x1	✓



Blocking Nut with Anti Kink Metal Spring	
1723 6/4-M10x1	✓
1723 8/6-M12x1	✓
1723 10/8-M14x1	✓
1723 12/10-M16x1	✓
1723 15/12.5-M20x1	✓



Plastic Washer	
2661 M3	✓
2661 M5	✓
2661 M6	✓
2661 1/8	✓
2661 1/4	✓
2661 3/8	✓
2661 1/2	✓



Plastic Washer	
2669 1/8	✓
2669 1/4	✓
2669 3/8	✓
2669 1/2	✓

Series 1000 Brass Nickel Plated Compression Fittings

Tube OD 4 - 6 - 8 - 10 - 12mm

Connections: BSP (1/8, 1/4) BSPT (1/8, 1/4, 3/8, 1/2)

Operating pressure: max 40 bar (see data for tubing used)

Operating temperature: (see data for tubing used)

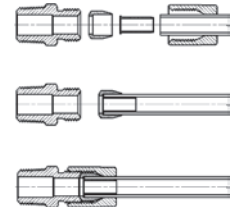

The Camozzi range of compression fittings are designed to assist with the assembly of fluid power components and systems. For technical specifications and assembly notes see 253 Full data sheets and dimensions available at <https://store.camozzi.co.uk>

Availability

- ✓ Ex Stock
- 🔧 UK Assembly
- 📞 Please Call Sales Office



* with bi-conical olive

BSPT Male Connector	
1050 4 -1/8	✓
1050 6 -1/8	✓
1050 6 -1/4	✓
1050 8 -1/8	✓
1050 8 -1/4	✓
1050 8 -3/8	✓
1050 10-1/4	✓
1050 10-3/8	✓
1050 10-1/2	✓
1050 12-1/4*	✓
1050 12-3/8*	✓
1050 12-1/2*	✓



BSP Female Connector	
1063 4 -1/8	✓
1063 6 -1/8	✓
1063 6 -1/4	✓
1063 8 -1/8	✓
1063 8 -1/4	✓



BSPT Fixed Male Elbow	
1020 4 -1/8	✓
1020 6 -1/8	✓
1020 6 -1/4	✓
1020 8 -1/8	✓
1020 8 -1/4	✓
1020 8 -3/8	✓
1020 10-1/4	✓
1020 10-3/8	✓
1020 10-1/2	✓
1020 12-1/4	✓
1020 12-3/8	✓
1020 12-1/2	✓



BSP Female Elbow	
1093 4 -1/8	✓
1093 6 -1/8	✓
1093 6 -1/4	✓
1093 8 -1/8	✓
1093 8 -1/4	✓



BSPT Fixed Male Tee	
1000 4 -1/8	✓
1000 6 -1/8	✓
1000 8 -1/4	✓
1000 10-1/4	✓



Lateral BSPT Fixed Male Tee	
1010 4 -1/8	✓
1010 6 -1/8	✓
1010 8 -1/4	✓
1010 10-1/4	✓



Union Connector	
1230 4	✓
1230 6	✓
1230 8	✓
1230 10	✓
1230 12	✓



Bulkhead Connector	
1250 4	✓
1250 6	✓
1250 8	✓
1250 10	✓



Elbow Connector	
1220 4	✓
1220 6	✓
1220 8	✓
1220 10	✓
1220 12	✓



Tee Connector	
1210 4	✓
1210 6	✓
1210 8	✓
1210 10	✓
1210 12	✓



Single Banjo	
1170 6-1/8*	✓
1170 6-1/4*	✓
1170 8-1/8°	✓

Assembly with Mod.
 * = 1631, 1635, SCU, SVU, SCO...
 ° = 1635, SCU, SVU, SCO...



Blocking Nut	
1303 4 -1/8	✓
1303 6 -1/8	✓
1303 8 -1/4	✓
1303 10-3/8	✓
1303 12-M18x1.5	✓

Compression Fittings

Availability

- ✓ Ex Stock
- 🔧 UK Assembly
- 📞 Please Call Sales Office



Olive	
1310 4	✓
1310 6	✓
1310 8	✓
1310 10	✓
1310 12-M18*	✓



Insert	
1320 4	✓
1320 6	✓
1320 8	✓
1320 10	✓

*biconical

Series S2000 Brass Nickel Plated Pipe Fittings Sprint®

Connections: BSP (1/8, 1/4, 3/8, 1/2) BSPT (1/8, 1/4, 3/8, 1/2)
 Operating pressure: 80 bar
 Operating temperature: -40°C - +120°C

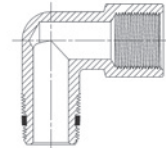

The more popular versions of the Camozzi Pipe Fittings are now available with the unique Camozzi Sprint® sealing system.

For technical specifications and assembly notes see page 253.
 Full data sheets and dimensions available at <https://store.camozzi.co.uk>

Availability

- ✓ Ex Stock
- 🔧 UK Assembly
- 📞 Please Call Sales Office

Sprint®



BSPT Nipple	
S2500 1/8	✓
S2500 1/4	✓
S2500 3/8	✓
S2500 1/2	✓

Sprint®



BSPT Reducing	
S2510 1/8-1/4	✓
S2510 1/8-3/8	✓
S2510 1/4-3/8	✓
S2510 1/4-1/2	✓
S2510 3/8-1/2	✓

Sprint®



BSPT Male Reducing Extension	
S2520 1/8-1/8	✓
S2520 1/8-1/4	✓
S2520 1/8-3/8	✓
S2520 1/4-1/4	✓
S2520 1/4-3/8	✓
S2520 1/4-1/2	✓
S2520 3/8-3/8	✓
S2520 3/8-1/2	✓
S2520 1/2-1/2	✓

Sprint®



BSPT Reducing Nipple	
S2530 1/4-1/8	✓
S2530 3/8-1/8	✓
S2530 1/2-1/8	✓
S2530 3/8-1/4	✓
S2530 1/2-1/4	✓
S2530 1/2-3/8	✓

Sprint®



BSPT Swivel Male Reduction	
2541 1/8-1/8	✓
2541 1/4-1/4	✓
2541 3/8-3/8	✓

Sprint®



BSPT Male Elbow	
S2010 1/8	✓
S2010 1/4	✓
S2010 3/8	✓
S2010 1/2	✓

Sprint®



Male Female Elbow	
S2020 1/8-1/8	✓
S2020 1/4-1/4	✓
S2020 3/8-3/8	✓
S2020 1/2-1/2	✓

Sprint®



M.M.F. Tee	
S2050 1/8-1/8	✓
S2050 1/4-1/4	✓
S2050 3/8-3/8	✓
S2050 1/2-1/2	✓

Pipe Fitting Sprint®

Availability

- ✓ Ex Stock
- 🔧 UK Assembly
- 📞 Please Call Sales Office

Sprint®



F.M.F. Tee	
S2060 1/8-1/8	✓
S2060 1/4-1/4	✓
S2060 3/8-3/8	✓
S2060 1/2-1/2	✓

Sprint®



M.F.F. Tee	
S2070 1/8-1/8	✓
S2070 1/4-1/4	✓
S2070 3/8-3/8	✓
S2070 1/2-1/2	✓

Sprint®



Male Tee	
S2080 1/8	✓
S2080 1/4	✓
S2080 3/8	✓
S2080 1/2	✓

Sprint®



M.F.M. Tee	
S2090 1/8-1/8	✓
S2090 1/4-1/4	✓
S2090 3/8-3/8	✓
S2090 1/2-1/2	✓

Sprint®



BSP Male Plug	
S2610 1/8	✓
S2610 1/4	✓
S2610 3/8	✓
S2610 1/2	✓



BSP Male Plug	
2612 M5	✓
2612 M7	✓
2612 1/8	✓
2612 1/4	✓
2612 3/8	✓
2612 1/2	✓

Sprint®



BSPT Male Plug Tapper	
S2615 1/8	✓
S2615 1/4	✓
S2615 3/8	✓



For Tubing
from page 342

Series 2000 Brass Nickel Plated Pipe Fittings

Connections: Metric (M5) BSP (1/8, 1/4, 3/8, 1/2, 3/4 and 1)
BSPT (1/8, 1/4, 3/8, 1/2, 3/4, 1)
Operating pressure: 80 bar
Operating temperature: -40°C - +120°C

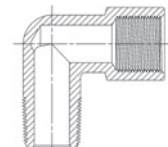

The Camozzi range of Pipe Fittings and hose tails are designed to assist with the assembly of fluid power components and systems.
For technical specifications and assembly notes see page 253.
Full data sheets and dimensions available at <https://store.camozzi.co.uk>

Availability

- ✓ Ex Stock
- 🔧 UK Assembly
- 📞 Please Call Sales Office



BSPT Nipple	
2500 1/8	✓
2500 1/4	✓
2500 3/8	✓
2500 1/2	✓
2500 3/4	✓
2500 1	✓



BSP Nipple	
2501 M5	✓
2501 1/8	✓
2501 1/4	✓
2501 3/8	✓
2501 1/2	✓



BSPT Reducing Nipple	
2510 1/8-1/4	✓
2510 1/8-3/8	✓
2510 1/4-3/8	✓
2510 1/4-1/2	✓
2510 3/8-1/2	✓
2510 1/2-3/4	✓



BSP Reducing Nipple	
2511 M5-1/8	✓
2511 1/8-1/4	✓
2511 1/8-3/8	✓
2511 1/4-3/8	✓
2511 1/4-1/2	✓
2511 3/8-1/2	✓

Series 2000 Brass Pipe Fittings

Availability

- ✓ Ex Stock
- 🔧 UK Assembly
- 📞 Please Call Sales Office



BSP Male Reducing Extension	
2520 1/8-1/8	✓
2520 1/8-1/4	✓
2520 1/8-3/8	✓
2520 1/4-1/4	✓
2520 1/4-3/8	✓
2520 1/4-1/2	✓
2520 3/8-3/8	✓
2520 3/8-1/2	✓
2520 1/2-1/2	✓



BSP Reducing Extension	
2521 M5-1/8	✓
2521 1/8-1/8	✓
2521 1/8-1/4	✓
2521 1/8-3/8	✓
2521 1/4-1/4	✓
2521 1/4-3/8	✓
2521 1/4-1/2	✓
2521 3/8-3/8	✓
2521 3/8-1/2	✓
2521 1/2-1/2	✓



BSP Male Extension	
2525 1/8-16	✓
2525 1/8-36	✓
2525 1/4-27	✓
2525 1/4-43	✓



BSPT Reducing	
2530 1/4-1/8	✓
2530 3/8-1/8	✓
2530 1/2-1/8	✓
2530 3/8-1/4	✓
2530 1/2-1/4	✓
2530 1/2-3/8	✓
2530 3/4-3/8	✓
2530 3/4-1/2	✓
2530 1-1/2	✓



BSP Reducing	
2531 1/8-M5*	✓
2531 1/4-1/8*	✓
2531 3/8-1/8	✓
2531 3/8-1/4*	✓
2531 1/2-1/8	✓
2531 1/2-1/4	✓
2531 1/2-3/8*	✓

*Models with through thread



Sleeve	
2543 M5	✓
2543 1/8	✓
2543 1/4	✓
2543 3/8	✓
2543 1/2	✓



Reducing Sleeve	
2553 M5-1/8	✓
2553 1/8-1/4	✓
2553 1/8-3/8	✓
2553 1/8-1/2	✓
2553 1/4-3/8	✓
2553 1/4-1/2	✓
2553 3/8-1/2	✓



BSP Male Plug	
2611 M5	✓
2611 1/8	✓
2611 1/4	✓
2611 3/8	✓
2611 1/2	✓
2611 1	✓



BSPT Male Plug	
2610 3/4	✓



Metric-BSP Male Hose Adaptor	
2601 2 -M5	✓
2601 4.5-M5	✓
2601 7 -1/8	✓
2601 7 -1/4	✓
2601 8 -1/8	✓
2601 9 -1/8	✓
2601 9 -1/4	✓
2601 9 -3/8	✓
2601 12-1/4	✓
2601 12-3/8	✓
2601 12-1/2	✓
2601 17-3/8	✓
2601 17-1/2	✓



BSP Male Elbow	
2010 1/8	✓
2010 1/4	✓
2010 3/8	✓
2010 1/2	✓
2010 3/4	✓
2010 1	✓



BSPT Female Elbow	
2013 1/8	✓
2013 1/4	✓
2013 3/8	✓
2013 1/2	✓



BSP Female Plug	
2613 1/8	✓
2613 1/4	✓
2613 3/8	✓
2613 1/2	✓

See page 275 for more hose tails

Series 2000 Brass Pipe Fittings

Availability

- ✓ Ex Stock
- 🔧 UK Assembly
- 📞 Please Call Sales Office



Male Female Elbow	
2021 M5-M5 ^o	✓
2020 1/8-1/8*	✓
2020 1/4-1/4*	✓
2020 3/8-3/8*	✓
2020 1/2-1/2*	✓
2020 3/4-3/4*	✓
2020 1-1*	✓

^o = BSP Male Female Elbow
* = BSPT Male Female Elbow



BSPT M.M.F. Tee	
2050 1/8-1/8	✓
2050 1/4-1/4	✓
2050 3/8-3/8	✓
2050 1/2-1/2	✓



BSPT F.M.F. Tee	
2060 1/8-1/8	✓
2060 1/4-1/4	✓
2060 3/8-3/8	✓
2060 1/2-1/2	✓



BSPT M.F.F. Tee	
2070 1/8-1/8	✓
2070 1/4-1/4	✓
2070 3/8-3/8	✓
2070 1/2-1/2	✓



BSPT Male Tee	
2080 1/8	✓
2080 1/4	✓
2080 3/8	✓
2080 1/2	✓
2080 3/4	✓
2080 1	✓



BSPT M.F.M. Tee	
2090 1/8-1/8	✓
2090 1/4-1/4	✓
2090 3/8-3/8	✓
2090 1/2-1/2	✓
2090 3/4-3/4	✓
2090 1	✓



BSP Female Tee	
2003 1/8	✓
2003 1/4	✓
2003 3/8	✓
2003 1/2	✓



BSPT Y.F.M.F.	
2040 1/8-1/8	✓
2040 1/4-1/4	✓
2040 3/8-3/8	✓
2040 1/2-1/2	✓



BSP Female Y	
2043 1/8	✓
2043 1/4	✓
2043 3/8	✓
2043 1/2	✓



BSP Female Cross	
2033 1/8	✓
2033 1/4	✓
2033 3/8	✓



Single Thread Banjo	
2023 M5-M5 ^o	✓
2023 M5-M6 ^o	✓
2023 1/8-1/8*	✓
2023 1/4-1/4 ^Λ	✓
2023 3/8-3/8 ^Λ	✓

Assembly with Mod.
 ● = 1631
 o = SCU, SVU, SCO...
 * = 1631, 1635, SCU, SVU, SCO...
 Λ = 1635, SCU, SVU, SCO...



Bulkhead Fitting Parallel	
2593 M16-1/8	✓
2593 M20-1/4	✓
2593 M26-3/8	✓
2593 M28-1/2	✓



Hexagon Locking Nut - BSPP	
1253 1/8	✓
1253 1/4	✓
1253 3/8	✓
1253 1/2	✓



Hexagon Locking Nut - Metric	
1593 M12x1	✓
1593 M20x1.5	✓



For Aluminium Manifold Blocks
See page 276

Brass Hose Tails and Connectors

Connections: 1/8 - 3/16 - 1/4 - 5/16 - 3/8 - 1/2 - 3/4 - 1
Brass hose tails and connectors.

Availability

- ✓ Ex Stock
- ✎ UK Assembly
- ⊗ Please Call Sales Office



Male Hose Connector	Taper Thread	Hose ID (mm)	Length (mm)
2700 2/2	⊗ 1/8 BSPT	1/8" (3)	30
2700 2/3	⊗ 1/8 BSPT	3/16" (5)	40
2700 2/4	⊗ 1/8 BSPT	1/4" (6)	40
2700 2/5	⊗ 1/8 BSPT	5/16" (8)	40
2700 2/6	⊗ 1/8 BSPT	3/8" (10)	42
2700 2/8	⊗ 1/8 BSPT	1/2" (12)	42
2700 4/2	⊗ 1/4 BSPT	1/8" (3)	34
2700 4/3	⊗ 1/4 BSPT	3/16" (5)	42
2700 4/4	⊗ 1/4 BSPT	1/4" (6)	42
2700 4/5	⊗ 1/4 BSPT	5/16" (8)	42
2700 4/6	⊗ 1/4 BSPT	3/8" (10)	42
2700 4/8	⊗ 1/4 BSPT	1/2" (12)	44
2700 4/10	⊗ 1/4 BSPT	5/8" (16)	44
2700 4/12	⊗ 1/4 BSPT	3/4" (18)	44
2700 6/3	⊗ 3/8 BSPT	3/16" (5)	39
2700 6/4	⊗ 3/8 BSPT	1/4" (6)	44
2700 6/5	⊗ 3/8 BSPT	5/16" (8)	44
2700 6/6	⊗ 3/8 BSPT	3/8" (10)	56
2700 6/8	⊗ 3/8 BSPT	1/2" (12)	56
2700 6/10	⊗ 3/8 BSPT	5/8" (16)	57
2700 6/12	⊗ 3/8 BSPT	3/4" (19)	59
2700 8/3	⊗ 1/2 BSPT	3/16" (5)	43
2700 8/4	⊗ 1/2 BSPT	1/4" (6)	43
2700 8/5	⊗ 1/2 BSPT	5/16" (8)	43
2700 8/6	⊗ 1/2 BSPT	3/8" (10)	60
2700 8/8	⊗ 1/2 BSPT	1/2" (12)	60
2700 8/10	⊗ 1/2 BSPT	5/8" (16)	60
2700 8/12	⊗ 1/2 BSPT	3/4" (19)	60
2700 8/16	⊗ 1/2 BSPT	1" (25)	60
2700 12/4	⊗ 3/4 BSPT	1/4" (6)	48
2700 12/5	⊗ 3/4 BSPT	5/16" (8)	48
2700 12/6	⊗ 3/4 BSPT	3/8" (10)	48
2700 12/8	⊗ 3/4 BSPT	1/2" (12)	63
2700 12/10	⊗ 3/4 BSPT	5/8" (16)	63
2700 12/12	⊗ 3/4 BSPT	3/4" (19)	63
2700 12/16	⊗ 3/4 BSPT	1" (25)	63

Hose Repair Connector	Hose ID (mm)	x	Hose ID (mm)
2780 3/3	⊗ 3/16" (5)	x	3/16" (5)
2780 4/4	⊗ 1/4" (6)	x	1/4" (6)
2780 5/5	⊗ 5/16" (8)	x	5/16" (8)
2780 6/4	⊗ 3/8" (10)	x	1/4" (6)
2780 6/6	⊗ 3/8" (10)	x	3/8" (10)
2780 8/6	⊗ 1/2" (10)	x	3/8" (10)
2780 8/8	⊗ 1/2" (12)	x	1/2" (12)
2780 10/10	⊗ 5/8" (16)	x	5/8" (16)
2780 12/8	⊗ 3/4" (19)	x	1/2" (12)
2780 12/12	⊗ 3/4" (19)	x	3/4" (19)
2780 16/12	⊗ 1" (25)	x	3/4" (19)
2780 16/16	⊗ 1" (25)	x	1" (25)



Hose Repair Connector "Y"	Hose ID
2760 04	⊗ 1/4"
2760 05	⊗ 5/16"
2760 06	⊗ 3/8"
2760 08	⊗ 1/2"

Hose Repair Connector "T"	Hose ID
2740 03	⊗ 3/16"
2740 04	⊗ 1/4"
2740 05	⊗ 5/16"
2740 06	⊗ 3/8"
2740 08	⊗ 1/2"



Worm Drive Clips - Mild Steel		Min ID	Max ID
WDC-1	⊗	9	12
WDC-2	⊗	11	16
WDC-3	⊗	13	20
WDC-4	⊗	14	22
WDC-5	⊗	17	25
WDC-6	⊗	22	30
WDC-7	⊗	25	35
WDC-8	⊗	30	40

Aluminium Distribution Manifold Blocks

Connections: 1/4 - 1/8 - 3/8 - 1/2

Aluminium manifold blocks to assist with the assembly of fluid power components and systems.

Other sizes and connections of manifolds can be supplied on request.

Availability

- ✓ Ex Stock
- ✎ UK Assembly
- ⌚ Please Call Sales Office

Aluminium Single-Sided Manifold



1/4" Inlet x 1/8" Outlet		No of Outlets
3053 1/4-3L-1/8	⌚	3
3053 1/4-4L-1/8	⌚	4
3053 1/4-5L-1/8	⌚	5
3053 1/4-6L-1/8	⌚	6

3/8" Inlet x 1/4" Outlet		No of Outlets
3053 3/8-3L-1/4	⌚	3
3053 3/8-4L-1/4	⌚	4
3053 3/8-5L-1/4	⌚	5
3053 3/8-6L-1/4	⌚	6

1/2" Inlet x 3/8" Outlet		No of Outlets
3053 1/2-3L-3/8	⌚	3
3053 1/2-4L-3/8	⌚	4
3053 1/2-5L-3/8	⌚	5
3053 1/2-6L-3/8	⌚	6

Aluminium Double-Sided Manifold



1/4" Inlet x 1/8" Outlet		No of Outlets
3043 1/4-3D-1/8	⌚	3+3
3043 1/4-4D-1/8	⌚	4+4
3043 1/4-5D-1/8	⌚	5+5
3043 1/4-6D-1/8	⌚	6+6

3/8" Inlet x 1/4" Outlet		No of Outlets
3043 3/8-3D-1/4	⌚	3+3
3043 3/8-4D-1/4	⌚	4+4
3043 3/8-5D-1/4	⌚	5+5
3043 3/8-6D-1/4	⌚	6+6

1/2" Inlet x 3/8" Outlet		No of Outlets
3043 1/2-3D-3/8	⌚	3+3
3043 1/2-4D-3/8	⌚	4+4
3043 1/2-5D-3/8	⌚	5+5
3043 1/2-6D-3/8	⌚	6+6

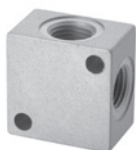

Aluminium Distribution Block		
3033 1/8	✓	1/8
3033 1/4	✓	1/4
3033 3/8	✓	3/8
3033 1/2	✓	1/2



For Cylinders
From page 3

Series 5000 Quick-Release Couplings

Nominal diameters: \varnothing 5 - 7 mm. Plastic tubes 6/4, 8/6, 10/8;
Rubber hoses 6x14 - 8x17 - 10x19 - 13x23
Connections: 1/8, 1/4, 3/8, 1/2

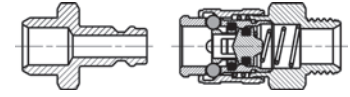

Availability

- ✓ Ex Stock
- ✦ UK Assembly
- ⊗ Please Call Sales Office

Operating pressure: min -0.99 bar - max 12 bar
Operating temperature: 0°C - +80°C (with dry air -20°C)

The Camozzi range of quick release couplings are designed to assist with the assembly of fluid power components and systems. For technical specifications see page 253.
Full data sheets and dimensions available at <https://store.camozzi.co.uk>

PNEUMATIC CONNECTION



BSP Male Quick Coupling	
5051 1/8	✓
5051 1/4	✓
5081 1/4	✓
5081 3/8	✓
5081 1/2	✓



BSP Male Quick Coupling Bulkhead	
5052 1/8	✓
5052 1/4	✓
5082 1/4	✓



BSP Female Quick Coupling	
5053 1/8	✓
5053 1/4	✓
5083 1/4	✓
5083 3/8	✓
5083 1/2	✓



Quick Coupling Push-on	
5054 6/4	✓
5054 8/6	✓
5084 8/6	✓
5084 10/8	✓



Quick Coupling Bulkhead Push-on	
5055 6/4	✓
5055 8/6	✓



Quick Coupling Hose Adapter	
5056 06	✓
5056 09	✓
5086 09	✓
5086 12	✓



Quick Coupling Hose Connector	
5057 6x14	✓
5087 6x14	✓
5087 8x17	✓
5087 10x19	✓
5087 13x23	✓



Quick Coupling with Anti Kink Spring	
5058 6/4	✓
5058 8/6	✓
5088 8/6	✓
5088 10/8	✓



Male Connector	
5150 1/8	✓
5150 1/4	✓
5180 1/4	✓
5180 3/8	✓
5180 1/2	✓



Female Connector	
5350 1/8	✓
5350 1/4	✓
5380 1/4	✓
5380 3/8	✓
5380 1/2	✓



Push-on Connector	
5450 6/4	✓
5450 8/6	✓
5480 8/6	✓
5480 10/8	✓



Connector with Barb	
5650 06	✓
5650 09	✓
5680 06	✓
5680 09	✓
5680 12	✓

Series 5000 Camozzi Quick-Release Couplings

Availability

- ✓ Ex Stock
- 🔧 UK Assembly
- 📞 Please Call Sales Office



Hose Connector	
5750 6x14	✓
5780 6x14	✓
5780 8x17	✓
5780 13x23	✓

Connector with Anti Kink Spring	
5850 6/4	✓
5850 8/6	✓
5880 8/6	✓
5880 10/8	✓

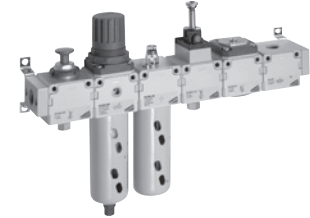

For FRL
From page 199

Series 5000L and 5000LT Quick-Release Couplings for the Conditioning of Moulds for Plastics

Nominal diameters: \varnothing 5 - 7 mm.
Couplings Threads: 1/8, 1/4, 3/8

- ✓ Ex Stock
- 🔧 UK Assembly
- 📞 Please Call Sales Office

Operating pressure: min -0.99 bar - max 12 bar
Operating temperature: -15°C - +140°C (200°C with oil)

The Series 5000L and 5000T couplings have been designed to connect tubes for water, air or oil, used within plastic injection and die casting moulds.

Full data sheets and dimensions available at <https://store.camozzi.co.uk>



BSP Female Quick Coupling	
5053L 1/8	📞
5053L 1/4	📞
5053LT 1/8	📞
5053LT 1/4	📞

BSP Female Quick Coupling	
5083L 1/4	📞
5083L 3/8	📞
5083LT 1/4	📞
5083LT 3/8	📞

Male Connector	
5150L 1/8	📞
5150L 1/4	📞
5180L 1/4	📞
5180L 3/8	📞

Series 9000 C-Truck Air Brake Fittings

Tube external diameters: 4, 6, 8, 10, 12, 15, 16 and 18mm.

Operating pressure: 0 - 16 bar

Operating temperature: -50°C - +100°C (see data for tubing used)

Availability

- ✓ Ex Stock
- ✂ UK Assembly
- 📞 Please Call Sales Office

Series C-Truck fittings have been designed for use in the pneumatic braking systems on commercial vehicles and are certified to TUV standards. The range has been designed so that assembly of the tube and fitting is made easy. All fittings are supplied preassembled and are therefore ready to use.

PNEUMATIC CONNECTION



Male Stud	Tube	Thread
9512 6-M10x1	✓ 6/4	M10x1
9512 6-M12x1.5R	✓ 6/4	M12x1.5
9512 6-M14x1.5R	✓ 6/4	M14x1.5
9512 6-M16x1.5R	✓ 6/4	M16x1.5
9512 8-M10x1	✓ 8/6	M10x1
9512 8-M12x1.5R	✓ 8/6	M12x1.5
9512 8-M14x1.5R	✓ 8/6	M14x1.5
9512 8-M16x1.5R	✓ 8/6	M16x1.5
9512 8-M22x1.5R	✓ 8/6	M22x1.5
9512 10-7 M12x1.5R	✓ 10/7	M12x1.5
9512 10-7 M16x1.5R	✓ 10/7	M16x1.5
9512 10-7 M22x1.5R	✓ 10/7	M22x1.5
9512 10-M12x1.5R	✓ 10/8	M12x1.5
9512 10-M16x1.5R	✓ 10/8	M16x1.5
9512 10-M22x1.5R	✓ 10/8	M22x1.5
9512 12-M12x1.5R	✓ 12/9	M12x1.5
9512 12-M14x1.5R	✓ 12/9	M14x1.5
9512 12-M16x1.5R	✓ 12/9	M16x1.5
9512 12-M22x1.5R	✓ 12/9	M22x1.5
9512 15-M16x1.5R	✓ 15/11	M16x1.5
9512 15-M22x1.5R	✓ 15/11	M22x1.5
9512 16/12-M16x1.5R	✓ 16/12	M16x1.5
9512 16-M22x1.5R	✓ 18/14	M22x1.5
9512 18-M22x1.5R	✓ 18/14	M22x1.5

Service Fitting	Tube	Thread
D6512 4-M10x1*	✓ 4/2	M10x1

* = supplied without insert



Male Stud	Tube	Thread
9510 6-02	✓ 6/4	1/8 NPTF
9510 05-02	✓ 8/6	1/8 NPTF



Female Stud	Tube	Thread
9463 6-M10x1	✓ 6/4	M10x1
9463 6-M12x1.5	✓ 6/4	M10x1
9463 6-M16x1.5	✓ 6/4	M16x1.5

Elbow	Tube	Thread
9502 6-M10x1R	✓ 6/4	M10x1
9502 6-M12x1.5R	✓ 6/4	M12x1.5
9502 6-M16x1.5R	✓ 6/4	M16x1.5
9502 6-M22x1.5R	✓ 6/4	M22x1.5
9502 8-M10x1R	✓ 8/6	M10x1
9502 8-M12x1.5R	✓ 8/6	M12x1.5
9502 8-M14x1.5R	✓ 8/6	M14x1.5
9502 8-M16x1.5R	✓ 8/6	M16x1.5
9502 8-M22x1.5R	✓ 8/6	M22x1.5
9502 10/7-M16x1.5R	✓ 10/7	M16x1.5
9502 10/7-M22x1.5R	✓ 10/7	M22x1.5
9502 10-M12x1.5R	✓ 10/8	M12x1.5
9502 10-M16x1.5R	✓ 10/8	M16x1.5
9502 10-M22x1.5R	✓ 10/8	M22x1.5
9502 12-M12x1.5R	✓ 12/9	M12x1.5
9502 12-M16x1.5R	✓ 12/9	M16x1.5
9502 12-M22x1.5R	✓ 12/9	M22x1.5
9502 15-M16x1.5R	✓ 15/11	M16x1.5
9502 15-M22x1.5R	✓ 15/11	M22x1.5
9502 16-12 M22x1.5R	✓ 16/12	M22x1.5
9502 16-M22x1.5R	✓ 16/12	M22x1.5
9502 18-M22x1.5R	✓ 18/14	M22x1.5

Series 9000 C-Truck Air Brake Fittings

Availability

- ✓ Ex Stock
- ✎ UK Assembly
- 📞 Please Call Sales Office



Fixed Male Elbow	Tube	Thread
9500 6-02	✓ 6/4	1/8 NPTF
9500 12-06	✓ 12/9	3/8 NPTF



Elbow	Tube
9550 6	✓ 6/4
9550 8	✓ 8/6
9550 10	✓ 10/8
9550 12	✓ 12/9
9550 10/7	✓ 10/7

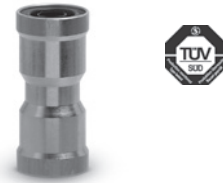

Tube to Tube Connector	Tube
9580 6	✓ 6/4
9580 8	✓ 8/6
9580 10-7	✓ 10/7
9580 10	✓ 10/8
9580 12	✓ 12/9
9580 15-11	✓ 15/11
9580 16-12	✓ 16/12
9580 18	✓ 18/14



Swivel Branch Tee	Tube	Thread
9412 6-M10x1R	✓ 6/4	M10x1
9412 6-M12x1.5R	✓ 6/4	M12x1.5
9412 6-M22x1.5R	✓ 6/4	M12x1.5
9412 8-M16x1.5R	✓ 8/6	M12x1.5
9412 8-M12x1.5R	✓ 8/6	M16x1.5
9412 8-M18x1.5R	✓ 8/6	M22x1.5
9412 8-M22x1.5R	✓ 8/6	M22x1.5
9412 10-M12x1.5R	✓ 10/8	M12x1.5
9412 10-M16x1.5R	✓ 10/8	M16x1.5
9412 12-M22x1.5R	✓ 12/9	M22x1.5
9412 15/11-M22x1.5R	✓ 15/11	M22x1.5
9412 15-M16x1.5R	✓ 15/12	M16x1.5



Swivel Run Tee	Tube	Thread
9422 6-M10x1R	✓ 6/4	M10x1
9422 6-M12-1.5R	✓ 6/4	M12x1.5
9422 8-M16x1.5R	✓ 8/6	M16x1.5
9422 8-M22x1.5R	✓ 8/6	M22x1.5
9422 10-M16x1.5R	✓ 10/8	M16x1.5
9422 10-M22x1.5R	✓ 10/8	M22x1.5
9422 12-M16x1.5R	✓ 12/9	M16x1.5
9422 12-M22x1.5R	✓ 12/9	M22x1.5



Bulkhead	Tube	Thread
9590 12-M18x1.5	✓ 12/9	M18x1.5
9590 12-M18x1.5S04	✓ 12/9	M18x1.5



Branch Tee	Tube	Thread
9410 6-02	✓ 6/4	1/8 NPTF
9410 05-02	✓ 8/6	1/8 NPTF



Bulkhead	Tube A	Tube B	Thread
9592 8-8-M18x1	✓ 8/6	8/6	M18x1
9592 12-8-M18x1	✓ 12/8	8/6	M18x1

Series 9000 C-Truck Air Brake Fittings

Availability

- ✓ Ex Stock
- 🔧 UK Assembly
- 📞 Please Call Sales Office



Equal Tube Tee		Tube
9540 6	✓	6/4
9540 8	✓	8/6
9540 10	✓	10/8
9540 12	✓	12/9
9540 15	✓	15/11
9540 8-8-6	✓	8/6
9540 12-12-8	✓	12/9



Y Fitting		Tube
9450 8-M16x1.5R	✓	8/6
9450 12-M22x1.5R	✓	12/9



Elbow		Tube
9402 12-M22x1.5R	✓	12/9



Bulkhead Adaptor		Thread A	Thread B
D2512 M22x1.5-M16x1.5R	✓	M22x1.5	M16x1.5
D2502 M22x1.5R-M22x1.5R	✓	M22x1.5	M22x1.5



Male Female Tee		Female Thread	Male Thread
D2072 M16x1.5-M16x1.5R	✓	M16x1.5	M16x1.5
D2072 M16x1.5-M22x1.5R	✓	M16x1.5	M22x1.5
D2072 M22x1.5-M22x1.5R	✓	M22x1.5	M22x1.5



Male Female Elbow		Male Thread	Female Thread
D2022 M16x1.5-M16x1.5R	✓	M16x1.5	M16x1.5
D2022 M16x1.5-M22x1.5R	✓	M22x1.5	M16x1.5
D2022 M22x1.5-M22x1.5R	✓	M22x1.5	M22x1.5

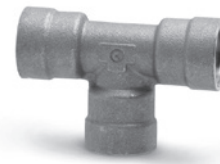

Equal Female Tee		Thread
D2003 M16x1.5	✓	M16x1.5
D2003 M22x1.5	✓	M22x1.5



Male Female Tee		Female Thread	Male Thread
D2062 M16x1.5-M12x1.5R	✓	M16x1.5	M12x1.5
D2062 M16x1.5-M16x1.5R	✓	M16x1.5	M16x1.5
D2062 M16x1.5-M22x1.5R	✓	M16x1.5	M22x1.5
D2062 M22x1.5-M22x1.5R	✓	M22x1.5	M22x1.5



Equal Female Tee		Thread
D2003 M16x1.5-S01	✓	M16x1.5

Series 9000 C-Truck Air Brake Fittings

Availability

- ✓ Ex Stock
- 🔧 UK Assembly
- 📞 Please Call Sales Office



Male - Female Cross	Male Thread	Female Thread
D2032 M16x1.5-M16x1.5R ✓	M16x1.5	M16x1.5



Hose Tail	Tube	Thread
D2602 10-M16x1.5-L=30 ✓	11	M16x1.5
D2602 11.5-M16x1.5-L=35 ✓	12.5	M16x1.5
D2602 12-M16x1.5R ✓	12.5	M16x1.5
D2602 12-M22x1.5R ✓	12.5	M22x1.5
D2602 13-M16x1.5-S01 ✓	15	M16x1.5



Male Female Elbow	Male Thread	Female Thread
D2077 M16x1.5-M16x1.5-S01R ✓	M16x1.5	M16x1.5
D2077 M16x1.5-M22x1.5-S01R ✓	M16x1.5	M22x1.5



Blanking Plug	Thread
D2612 M12x1.5R ✓	M12x1.5
D2612 M16x1.5R ✓	M16x1.5
D2612 M22x1.5R ✓	M22x1.5



Fitting	Thread
D3043 M16X1.5-2D-M16X1.5-S01 ✓	M16x1.5



Test Point	Thread A	Thread B
VPC2 M16x1.5R-M16x1.5 ✓	M16x1.5	M16x1.5
VPC2 M22x1.5R-M16x1.5 ✓	M22x1.5	M16x1.5



Bleed Point	Thread
VDC2 M22x1.5R ✓	M22x1.5



Tyre Inflator Valve	Thread
V604 M22x1.5R ✓	M22x1.5

Series 9000 C-Truck Air Brake Fittings

Availability

- ✓ Ex Stock
- ✂ UK Assembly
- 📞 Please Call Sales Office



Tube Cutters	
PNZ-12	✓
PNZ-25	✓



Tube Cutters	
PNZP-12	✓



Disconnection Key		Tube
DRK 6	✓	6
DRK 8	✓	8
DRK 10	✓	10
DRK 12	✓	12
DRK 15	✓	15
DRK 16	✓	16
DRK 18	✓	18



For Tubing
From page 342

Electric Actuation

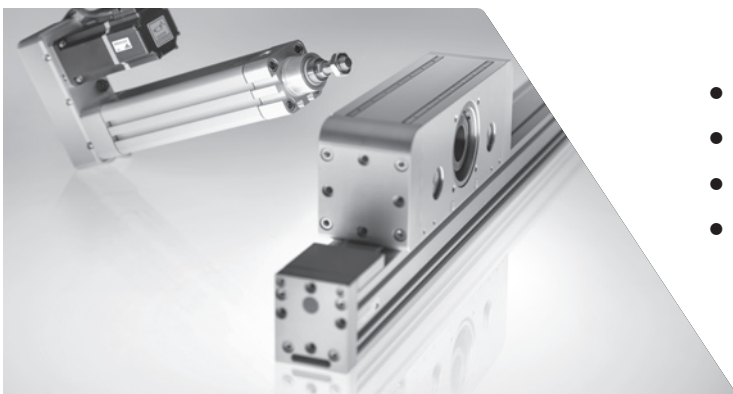

- Electromechanical cylinders
- Electromechanical Axes
- Drives
- Motors

Ball Valves and Non Return Valves

1 Brass Two-Way Ball Valves (Premium)

	Page
 Mini Ball Valves	285
 Brass Ball Valves - Gas/WRAS Approved	286



2 Stainless Steel Two-Way Ball Valves

	Page
 Economy Stainless Steel Ball Valves - Two-Piece Design	287



3 Stainless Steel Three-Way Ball Valves

	Page
 Stainless Steel Ball Valves Three-Piece Design	288

4 Direct Mount Ball Valves (for actuation)

	Page
 Brass Ball Valves - with ISO Pad	289
 Stainless Steel Ball Valves - with ISO Pad	290

5 Exhausting Brass Ball Valves

	Page
 Brass Ball Valves - Exhausting - with Locking Handle	291
 Lockable Safety Ball Valve	292

6 Brass Three-Way Ball Valves

	Page
 Brass Ball Valves Three-Way - with ISO 5211 Pad	293

7 Non-Return Valves

	Page
 Non-Return Valves	294

Mini Ball Valves

Connections: 1/8, 1/4, 3/8, 1/2

Our range of Mini Ball Valves offers a wide variety of choices for the design engineer.

Part Number: 3830*
Lever - Female/Female

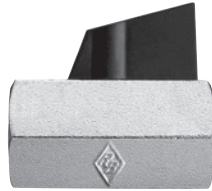

3830

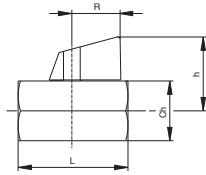

Part Number: 3831*
Lever - Male/Female

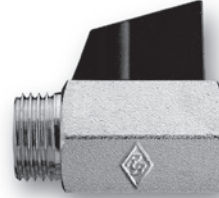

3831

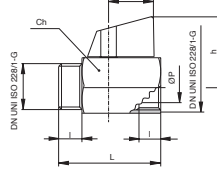

Part Number: 3730*
Lever - Female/Female

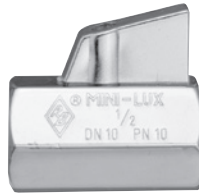

3730

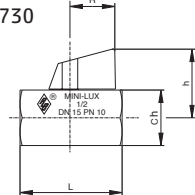

Part Number: 3731*
Lever - Male/Female



3731

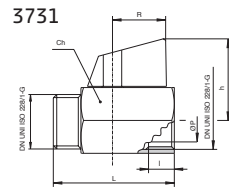

Part Number: 3860*
Screwdriver - Female/Female



3860

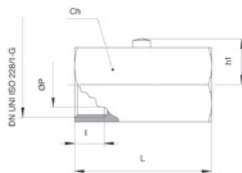

Part Number: 3861*
Screwdriver - Male/Female

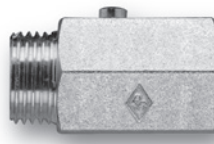

3861

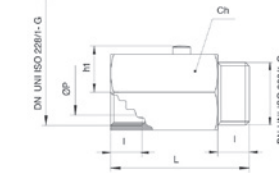

Technical Data

Media

Most non-corrosive liquids and gases including air, water and fuels

Operating Pressure

10 bar (147 p.s.i.)

Operating Temperature

-20°C to +90°C (detail of valves for higher temperatures available on request)

Flow Rate

Flow rates stated in Kv: Flow coefficient in m³/h at differential pressure of 100kPa

Threads

UNI ISO 228/1

Materials

Body: Brass, chrome plated, types 3730 and 3731 polished chrome plated

Handle: Plastic, types 3830 and 3831 black, types 3730 and 3731 plastic chromed

Ball: Brass, chrome plated

Main Seal: PTFE

Stem Seal: NBR. Viton on request

Actuation Details

90° rotation of lever

We recommend that the valve is used in either the fully open or fully closed position. In addition, the valve should be actuated at least twice a year

Additional Options

NPT screwed end connections (M/F and F/F)

Viton stem seal for higher temperatures

Special Requests

For assistance, contact our technical office or your local Camozzi distributor.

- ✓ Ex Stock
- 🔧 UK Assembly
- ☎ Please Call Sales Office

Dimensions (mm)		DN	ØP	I	L	h	h1	Ch	R	Kv	PN
*1/8	✓	6	8	8	41	29	13.8	21	20.5	4.3	10
*1/4	✓	8	8	10	41	29	13.8	21	20.5	4.3	10
*3/8	✓	10	8	10	41	29	13.8	21	20.5	2.7	10
*1/2	✓	15	10	11	46	31	15.8	25	20.5	5.4	10

Brass Ball Valves - Gas/WRAS Approved

Connections: 1/4, 3/8, 1/2, 3/4, 1, 1 1/4, 1 1/2, 2, 2 1/2, 3, 4

Our range of Brass Ball Valves offering a cost saving solution suitable for many applications.

Part Number: 1600*

Aluminium Handle - Female/Female. WRAS Approved

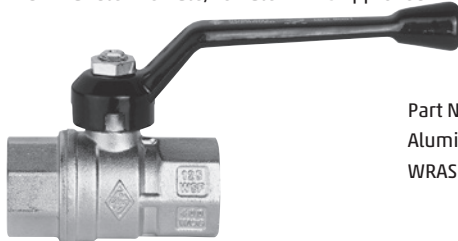

Part Number: 1620* (1/4 - 1 only)

Aluminium Butterfly Handle - Female/Female.

WRAS Approved

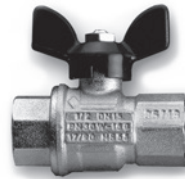

Part Number: 1610*

Steel with Black Plastic Coated Handle - Female/Female.

WRAS Approved

Part Number: 6273*

Steel with Yellow Plastic Coated Handle - Female/Female

Gas approved to BSEN331 1998

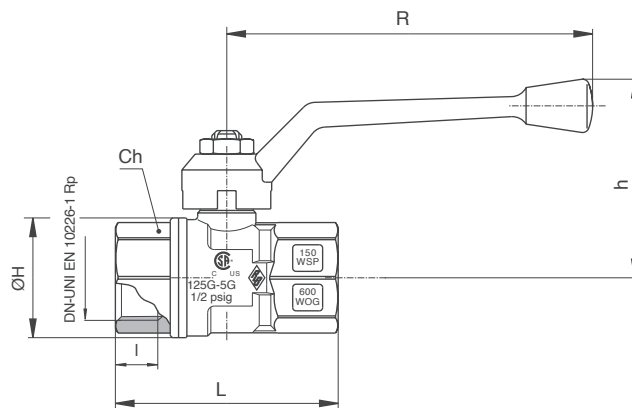

Technical Data

Media

Most non-corrosive liquids and gases including air, water, solvents and fuels.

6273 range gas approved to BSEN331 1998 (MOP 5 Bar -20 to +60°C)

Operating Pressure

Nominal working pressure (PN) in bar. (see chart)

Operating Temperature

-20°C to +160°C

Flow Rates

Flow rates stated in Kv: Flow coefficient in m³/h at differential pressure of 100kPa

Threads

Female-Female UNI ISO 7/1

Materials

Body: Nickel plated brass

Ball: Chromed brass

Seals: PTFE

Stem Seals: NBR

Lever Handle: Steel black enamelled

'T' Handle: Aluminium black enamelled

Actuation

90° rotation of the lever.

We recommend that the valve is used in either the fully open or fully closed position. In addition, the valve should be actuated at least twice a year

Additional Options

Female/Female NPT

Male/Female Threads



Extension Stem



Special Requests

For assistance, contact our technical office or your local Camozzi distributor.

✓ Ex Stock

✎ UK Assembly

☎ Please Call Sales Office

Dimensions (mm) and Pressures

		DN	l	Ch	ØH	L	h	R	Kv	PN
*1/4	✓	8	11	20	23	51.5	47.5	95	5.4	64
*3/8	✓	10	11.4	20	23	51.5	47.5	95	6	64
*1/2	✓	15	15	25	30	59	48.5	95	16.3	30
*3/4	✓	20	16.3	31	36	67	59.5	110	29.5	30
*1	✓	25	19.1	38	43.5	81.5	62	110	43	30
*1 1/4	✓	32	21.4	48	53	94	76	160	89	25
*1 1/2	✓	40	21.4	54	65	102.5	81.5	160	230	25
*2	✓	50	25.7	67	80	123	99.5	170	265	25
*2 1/2	✓	65	30.2	90	111	152	129	205	540	25
*3	✓	80	33.3	105	136	177	140	205	873	25
*4	✓	100	39.3	130	166	214	160	260	1390	25

Economy Stainless Steel Ball Valves - Two-Piece Design

Connections: 1/4, 3/8, 1/2, 3/4, 1, 1 1/4, 1 1/2, 2

2-piece Stainless Steel Quarter Turn Ball Valve with all wetted parts Stainless Steel AISI316. Other metal parts in Stainless Steel AISI304. Available with NPT Threads.

Part Number: 704000*

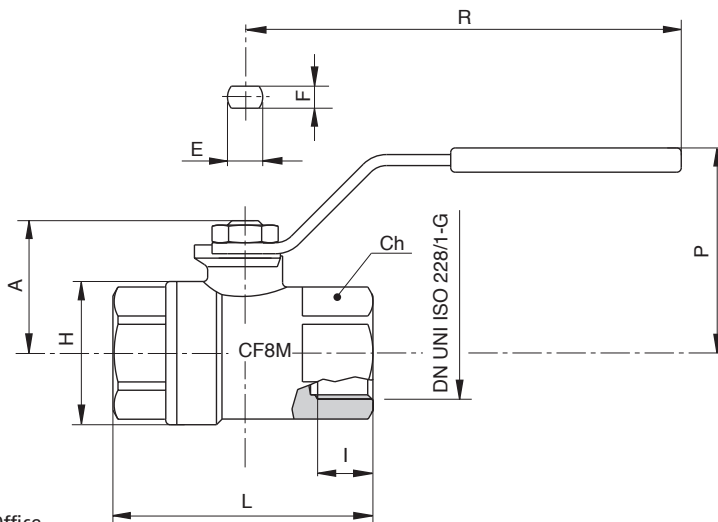
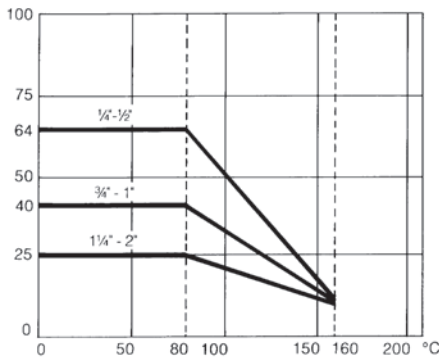
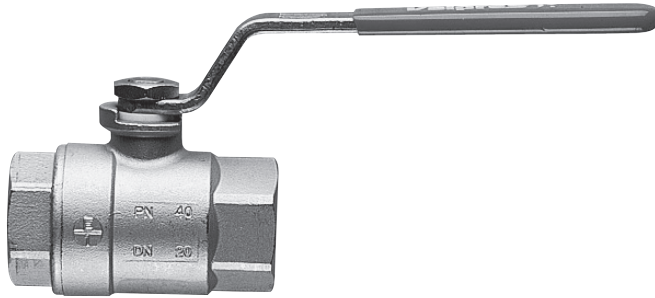

- ✓ Ex Stock
- ✂ UK Assembly
- ☎ Please Call Sales Office

Dimensions (mm) and Pressures

	Size	DN	A	H	L	R	Ch	I	E	F	P	Kv	PN	Kg
*02	✓ 1/4	8	28	30	53.5	110	ES.22	10	8	5	44	5.5	64	0.22
*03	✓ 3/8	10	28	30	53.5	110	ES.22	10	8	5	44	8.5	64	0.20
*04	✓ 1/2	15	30.5	32.5	60	110	ES.27	13	8	5	47	19.2	64	0.25
*05	✓ 3/4	20	37	40	70	131	ES.32	14	10	7	54	35.0	40	0.45
*06	✓ 1	25	41	49	79	131	OT.41	17	10	7	58	64.5	40	0.85
*07	✓ 1 1/4	32	50	62	91	174	OT.50	19	12	8	70	103.8	25	1.20
*08	✓ 1 1/2	40	57	75	103	174	OT.55	19.5	12	8	76	174.0	25	1.80
*10	✓ 2	50	66	95	124	174	OT.70	22.5	12	8	86	301.3	25	2.70

Technical Data

Media

Any application with media suitable to material of construction

Operating Pressure

Nominal working pressure (PN) in

BAR -

See chart

Vacuum: Maximum 10⁻³ torr.

Operating Temperature

-20°C to +160°C

Flow Rates

Flow rates stated in Kv: Flow coefficient in m³/h at differential pressure of 100kPa

Threads

ISO 228/1

Materials

Body: CF8M Stainless Steel

Ball: CF8M Stainless Steel

Seals: PTFE

Handle: Stainless Steel AISI430 with plastic grip

Actuation

90° rotation of lever

We recommend that the valve is used in either the fully open or fully closed position. In addition, the valve should be actuated at least twice a year

Additional Options

700023 - Female/Female NPT



Also available in Carbon Steel 705000

Special Requests

For assistance, contact our technical office.

Stainless Steel Ball Valves Three-Piece Design



Connections: 1/4, 3/8, 1/2, 3/4, 1, 1 1/4, 1 1/2, 2, 2 1/2, 3, 4

Full bore Valves for quarter turn on-off control of most non-corrosive and some corrosive liquids and gases compatible with the technical data below. Socket weld and butt weld types available.

Part Number: 710000* - Female/Female
711000* - Socket Weld
712000* - Butt Weld

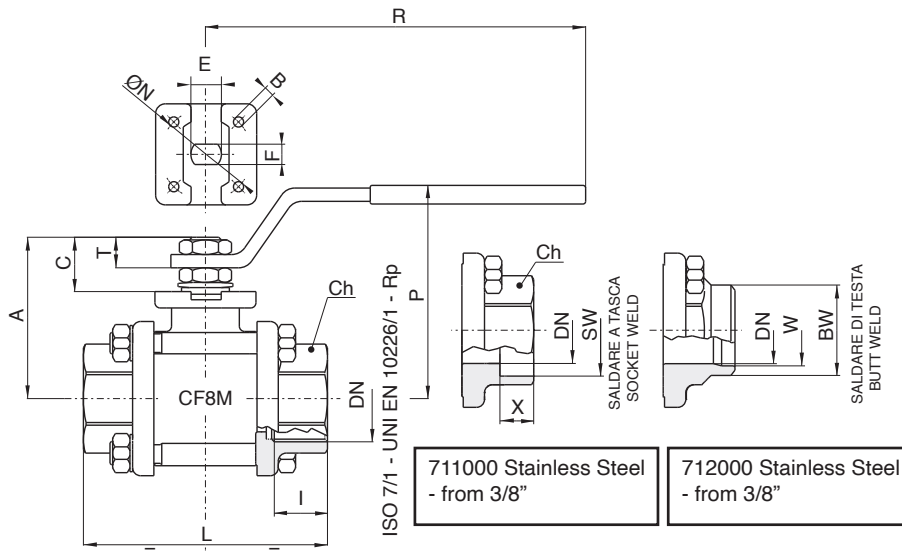
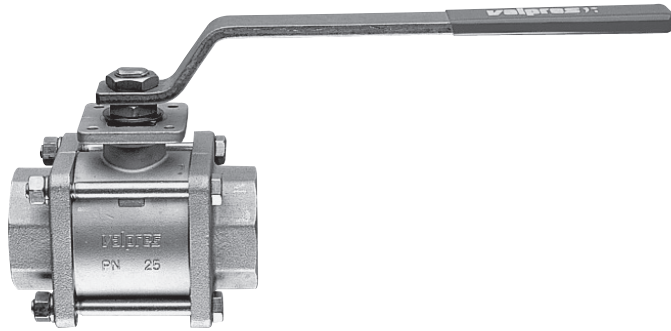

- ✓ Ex Stock
- ✎ UK Assembly
- ☎ Please Call Sales Office

Dimensions (mm)																					
	Size	DN	SW	X	BW	W	I	L	Ch	R	P	A	C	T	E	F	N	B	Kv	PN	Kg
*02	✓ 1/4	8	-	-	-	-	11	57	OT.22	110	50	35	13.5	9	8	5	-	-	5.5	64	0.28
*03	✓ 3/8	10	18.2	9.5	17.1	12.48	11.4	57	OT.22	110	50	35	13.5	9	8	5	-	-	8.5	64	0.27
*04	✓ 1/2	15	22.4	9.5	21.3	15.76	15	65	OT.27	131	64	47	15	10	10	7	36	6	19.2	64	0.50
*05	✓ 3/4	20	27.7	11.1	26.7	20.96	16.3	76	OT.32	131	68	52	16	10	10	7	42	5.5	35.0	40	0.70
*06	✓ 1	25	34.5	12.7	33.4	26.64	19.1	92	OT.41	174	79	60	19.5	12.5	12	8	42	6	64.5	40	1.20
*07	✓ 1 1/4	32	43.2	14.3	42.2	35.08	21.4	106.5	OT.50	174	83	64	19.5	12.5	12	8	42	5.5	103.8	25	1.70
*08	✓ 1 1/2	40	49.5	15.9	48.3	40.94	21.4	116	OT.55	250	100	79	24	16.5	16	10	50	6.5	174.0	25	2.50
*10	✓ 2	50	62	17.5	60.3	52.48	25.7	136	OT.70	250	107	86	24	16.5	16	10	50	6.5	301.3	25	3.90
*12	✓ 2 1/2	65	76.5	20	73	62.68	30.2	153.5	Ø90	321	126	103	28	18	20	14	70	M8	545.7	16	8.15
*14	✓ 3	80	89.5	20	88.9	77.92	33.3	180	Ø105	321	137	114	28	18	20	14	70	M8	872.5	16	12.80
*18	✓ 4	100	115	20	114.3	102.26	39.3	217	Ø130	381	156	137	34.5	22	24	18	102	M10	1363.3	16	21.50

Technical Data
Media
 Any application with media suitable to material of construction
Operating Pressure
 Nominal working pressure (PN) in BAR - See chart
 Vacuum: Maximum 10⁻³ torr.
Operating Temperature
 -20°C to +160°C
Flow Rates
 Flow rates stated in Kv: Flow coefficient in m³/h at differential pressure of 100kPa
Threads/Connections
 710000 - Female/Female ISO 7/1
 711000 - Socket Weld
 712000 - Butt Weld
Material
 Body, Spindle: CF8M Stainless Steel
 Ball: AISI316-CF8M Stainless Steel
 Seals: PTFE (Weld end valves 15% glass reinforced)
 90° Cam, Lever: Stainless Steel AISI430
 Stem O Ring: Viton
 Other metal Parts: Stainless Steel AISI303, 305
Actuation
 90° rotation of lever
 We recommend that the valve is used in either the fully open or fully closed position. In addition, the valve should be actuated at least twice a year
Additional Options
 710001 - Female/Female NPT B.1.20.1
 710009 - Female/Female PTFE Cavity Filled Seat
 710168 - Female/Female Gas Antistatic Device
V Ball Option

Special Requests
 For assistance, contact our technical office

BALL VALVES AND NON RETURN VALVES

Brass Ball Valves - with ISO Pad

Connections: 1/4, 3/8, 1/2, 3/4, 1, 1 1/4, 1 1/2, 2, 2 1/2, 3, 4

Full bore brass ball valves with ISO 5211 mounting pad for direct mounting of pneumatic/electric actuators for on-off applications of most non-corrosive media. Body seals energised with Viton 'O' rings.

Only for actuation - no lever available

Part Number: 2500* ISO

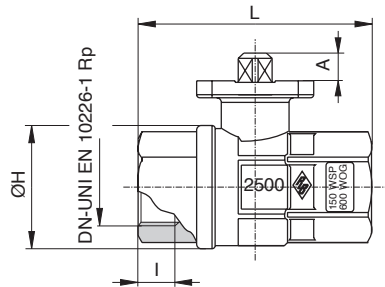
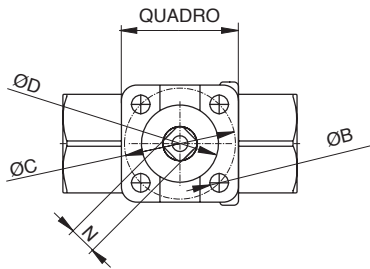
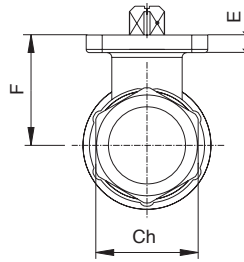
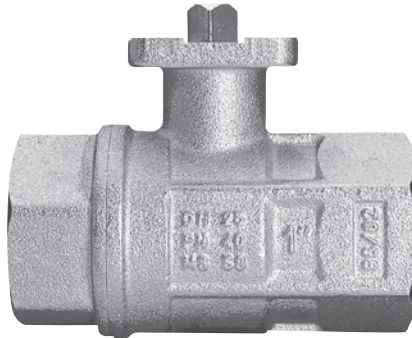

Technical Data

Media

Most non-corrosive liquids and gases including air, water, solvents, fuels and propane

Operating Pressure

Nominal working pressure (PN) in BAR - See chart

Operating Temperature

-20°C to +160°C

Flow Rates

Flow rates stated in Kv: Flow coefficient in m³/h at differential pressure of 100kPa

Threads

UNI ISO 7/1

Materials

Body: Brass, nickel plated
Ball: Brass, chrome plated
Seals: PTFE with Viton 'O' Ring
Size: 1/4" to 4" UNI ISO 7/1

Actuation Details

Refer to chart for torque and pad details

Additional Options

NPTF - Series 250N



Available with spring return (dead mans) lever.



Available with Pneumatic Actuators



Available with Electric Actuators

Special Requests

For assistance, contact our technical office or your local Camozzi distributor.

- ✓ Ex Stock
- 🔧 UK Assembly
- ☎ Please Call Sales Office

Dimensions (mm) and Pressures

	DN	Quadro	I	Ch	ØH	L	ISO 5211					E	F	N	Kv	PN	Kg
							A	ØB	ØC	ØD	S						
*1/4	✓ 8	38	11	27	33.5	67	9	6	36	25	2	5.5	32.5	9	5.4	40	0.37
*3/8	✓ 10	38	11.4	27	33.5	67	9	6	36	25	2	5.5	32.5	9	6	40	0.35
*1/2	✓ 15	38	15	27	33.5	67	9	6	36	25	2	5.5	32.5	9	16.3	40	0.31
*3/4	✓ 20	38	16.3	32	40	76	9	6	36	25	2	5.5	34.5	9	29.5	40	0.40
*1	✓ 25	38	19.1	41	49	90	9	6	36	25	3	6	45.5	9	43	40	0.75
*1 1/4	✓ 32	38	21.4	50	58.5	102	9	6	36	25	3	6	59	9	89	40	1.05
*1 1/2	✓ 40	50	21.4	55	73	114	11	7	50	35	3	10	64	11	230	40	1.73
*2	✓ 50	50	25.7	70	91.5	138	11	7	50	35	3	8	73.2	11	265	40	2.98
*2 1/2	✓ 65	70	30.2	90	114.5	165	15	9	70	55	3	9	88.5	14	540	25	4.20
*3	✓ 80	70	33.3	105	136	188	15	9	70	55	3	9	98	14	873	16	6.28
*4	✓ 100	70	39.3	130	166	225	17.5	9	70	55	3	8.5	116.5	17	1390	16	10.25

Stainless Steel Ball Valves - with ISO Pad

ATEX

Connections: 1/2, 3/4, 1, 1 1/4, 1 1/2, 2, 3

Full bore stainless steel ball valves with ISO 5211 mounting pad for direct mounting of pneumatic/electric actuators for on-off applications of most non-corrosive media. Body seals energised with Viton 'O' rings.

Part Number: 703000*

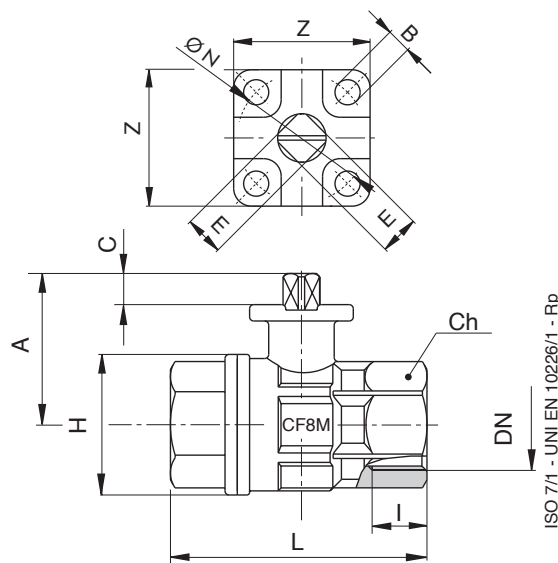
**Technical Data****Media**

Any application with media suitable to stainless steel (materials of construction)

Operating Pressure

Nominal working pressure (PN) in BAR - See chart

Operating Temperature

-20°C to +160°C

Flow Rates

Flow rates stated in Kv: Flow coefficient in m³/h at differential pressure of 100kPa

Threads

ISO 7/1 RP

Materials

Body: CF8M

Ball: AISI 316

Seals: PTFE with Viton 'O' Ring

Stem: AISI 316

Size: 1/4 to 2 UNI ISO 7/1

Actuation Details

Refer to chart for torque and pad details

Additional Options

NPTF - Series 700076



Available with spring return (dead mans) lever.



Available with Pneumatic Actuators



Available with Electric Actuators

Special Requests

For assistance, contact our technical office or your local Camozzi distributor.

✓ Ex Stock

🇬🇧 UK Assembly

☎ Please Call Sales Office

Dimensions (mm) and Pressures

	Threads	DN	I	L	H	Ch	A	C	E	ØN	B	Z	Kv	PN	Kg
*04	✓ 1/2	15	15	67	34.5	ES.27	41.5	9	9	36	6	38	19.2	64	0.30
*05	✓ 3/4	20	16.3	78	42	ES.32	43.5	9	9	36	6	38	35	64	0.40
*06	✓ 1	25	19.1	90	51.5	ES.41	53.5	9	9	36	6	38	64.5	64	0.70
*07	✓ 1 1/4	32	21.4	100	64.5	OT.50	57	9	9	36	6	38	103.8	64	1.04
*08	✓ 1 1/2	40	21.4	112	77	OT.55	74	11	11	50	7	50	174	64	1.68
*10	✓ 2	50	25.7	135	97	OT.70	83.3	11	11	50	7	50	301.3	64	2.95
*14	✓ 3	80	33.3	180	145	105	120	17.5	17	70	9	64	872.5	25	9.50

New version

Brass Ball Valves - Exhausting - with Locking Handle

Connections: 1/4, 3/8, 1/2, 3/4, 1

For use as an on-off valve for pneumatic systems.

In the off position, downstream air is exhausted to atmosphere through a small vent hole in the valve body. In this way the danger of pressurised air remaining in the system after shut-off can be eliminated.

Part Number: 5110*

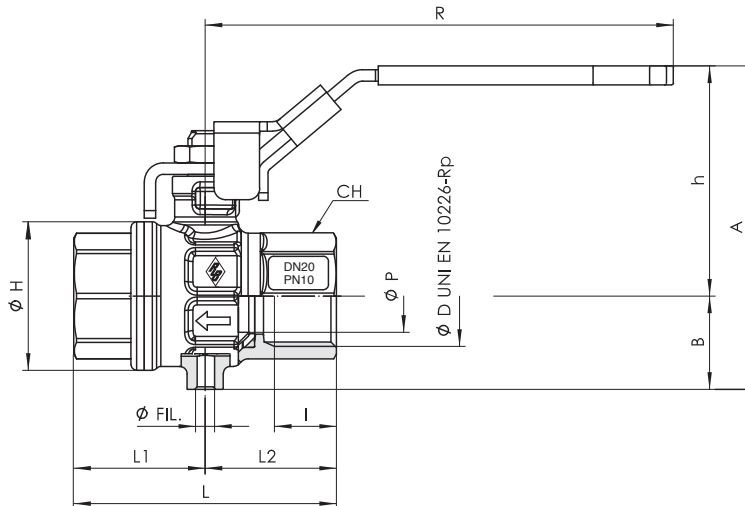
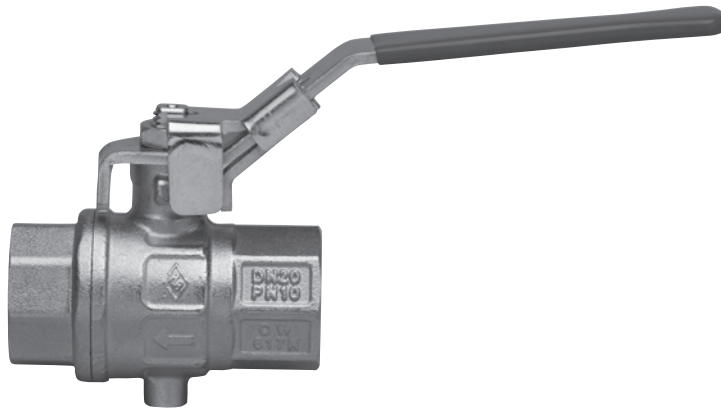

Technical Data

Media

Compressed Air

Operating Pressure

10 bar

Operating Temperature

-10°C to +100°C

Flow Rates

Flow rates stated in Kv: Flow coefficient in m³/h at differential pressure of 100kPa

Threads

UNI ISO 7/1

Materials

Body: Brass, nickel plated

Ball: Brass, hard chrome

Seals: PTFE

Handle: Steel zinc plated, red plastic coated

Direction flow: As indicated by arrow

Connections: 1/4 to 1 UNI ISO 7/1

Flow coefficient m³/h - see Kv column of dimensions

Actuation Details

As per 1700 valve

Additional Options

Lockable handle

Special Requests

For assistance, contact our technical office or your local Camozzi distributor.

✓ Ex Stock

🔧 UK Assembly

☎ Please Call Sales Office

Dimensions (mm) and Pressures

	DN	ØP	A	B	h	ØH	I	L	L1	L2	R	Ch	ØFil	Kv	PN	Kg
*1/4 ✓	8	10	61.5	15.5	46	23	11	51.5	27.5	24	96	20	M5	5.4	10	0.18
*3/8 ✓	10	10	61.5	15.5	46	23	11.4	51.5	27.5	24	96	20	M5	6	10	0.16
*1/2 ✓	15	14	69.7	20	49.7	33	15	62	31	31	96	25	M5	15.7	10	0.24
*3/4 ✓	20	19	85	24.5	60.5	39	16.3	69	34.5	34.5	123	31	M5	28	10	0.40
*1 ✓	25	24	94.3	29	65.3	49	19.1	83	41.5	41.5	123	38	M5	41.5	10	0.61

Lockable Safety Ball Valve

Connections: 1/4, 3/8, 1/2, 1

Our lockable safety ball valve is for use as an on-off valve for pneumatic systems. In off position, vent hole in valve body allows air to be exhausted. In the off position, downstream air is exhausted to atmosphere through a small vent hole in the valve body. Locking feature allows maintenance and setting activities to be carried out safely on the system and prevents air supply being reactivated inadvertently.

Part Number: S93*



Technical Data

Media

For use as an on-off valve for pneumatic systems

Operating Pressure

0 to 16 bar

Operating Temperature

-20°C to +90°C

Threads

UNI ISO 7/1

Materials

Body: Brass, nickel plated

Ball: Brass, hard chrome

Seals: PTFE

Handle: Steel zinc plated, blue plastic coated

Direction flow: As indicated by arrow

Special Requests

For assistance, contact our technical office or your local Camozzi distributor.

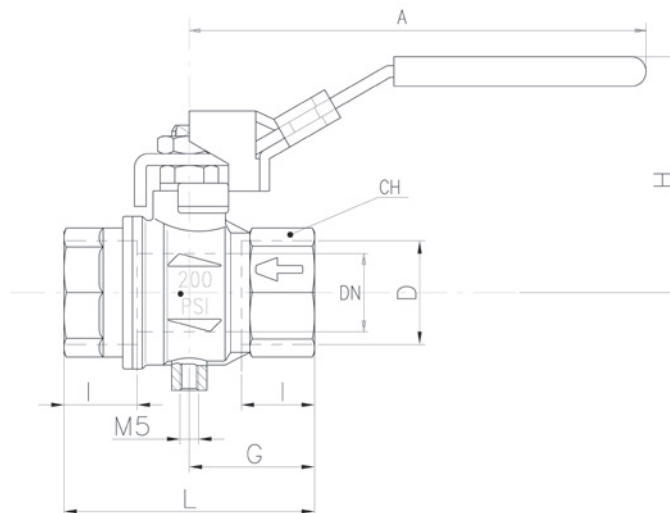

✓ Ex Stock

✦ UK Assembly

ⓞ Please Call Sales Office

	D(inch)	DN(mm)	J(mm)	L(mm)	G(mm)	A(mm)	H(mm)	AF(mm)
*B00 ✓	1/4	8	12	45	22.5	96	47.5	20
*C00 ✓	3/8	9.5	12	45	22.5	96	47.5	20
*D00 ✓	1/2	15	15.5	59	29.5	96	52	25
*F00 ✓	1	24	21	81	40.5	117	63.5	40

Brass Ball Valves Three-Way - with ISO 5211 Pad

Connections: 1/4, 3/8, 1/2, 3/4, 1, 1 1/4, 1 1/2, 2

Full bore, 3-way L-port or T-port ball valves for control of air, water, oil and some solvents and fuels. On site selection of desired flowpath by simple lever positioning system (see chart below). ISO Pad for direct mounting of actuator.

Part Number: 3500* (T-port), 3600 (L-Port)

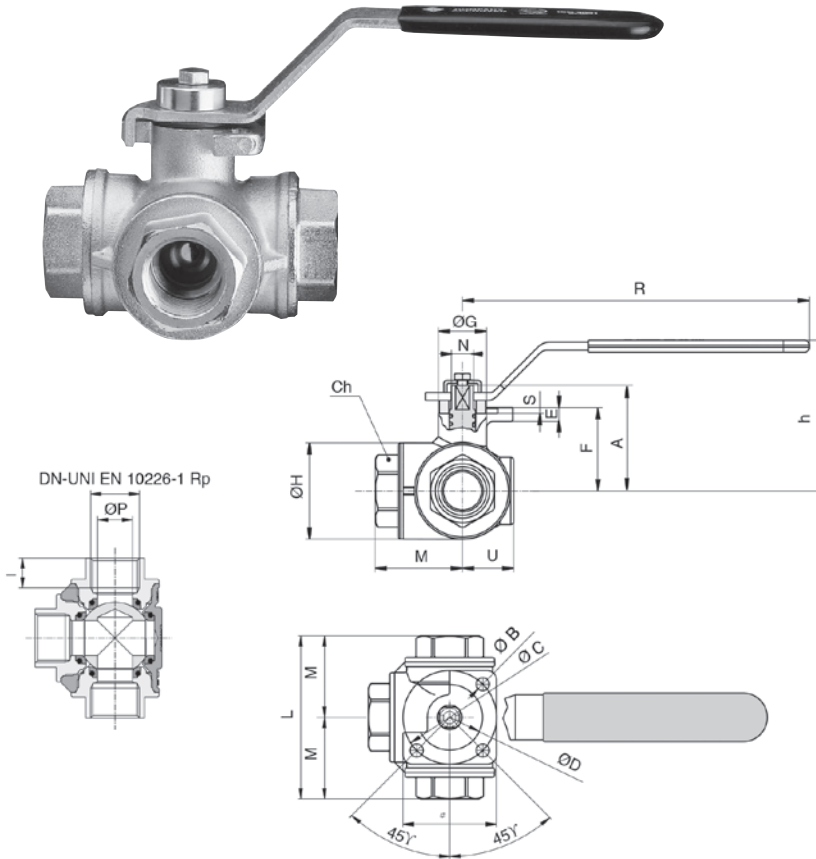

Technical Data

Media

Most non-corrosive liquids and gases including air, water, solvents, fuels and propane.

Operating Pressure

Nominal working pressure (PN) in BAR - See chart

Operating Temperature

-20°C to +160°C

Flow Rates

Flow rates stated in Kv: Flow coefficient in m³/h at differential pressure of 100kPa

Threads

UNI ISO 7/1

Materials

Body: Brass, Nickel-plated
Balls: Brass, hard chromed
Seal: PTFE and VITON
Lever: Steel, plastic coated black

Actuation Details

90° rotation of lever. We recommend that the valve is used in either the fully open or fully closed position. In addition, the valve should be actuated at least twice a year

Additional Options

NPTF - NPT

Special Requests

For assistance, contact our technical office or your local Camozzi distributor.

- ✓ Ex Stock
- 🔧 UK Assembly
- 📞 Please Call Sales Office

Dimensions (mm) and Pressures							ISO 5211																
Size	DN	ØP	I	Ch	ØH	L	A	ØB	ØD	ØC	E	F	Quadro	ØG	M	N	S	U	h	R	Kv	PN	Kg
*1/4	✓ 8	11	11	22	34	67	9	6	25	36 F03	5	30.5	38	22	33.5	9	2	19.5	62	120	2.8	30	0.55
*3/8	✓ 10	11	11.4	22	34	67	9	6	25	36 F03	5	30.5	38	22	33.5	9	2	19.5	62	120	3	30	0.52
*1/2	✓ 15	14	15	27	39	77	9	6	25	36 F03	5	32.5	38	22	38.5	9	2	22	64	120	3.9	30	0.65
*3/4	✓ 20	19	16.3	32	48	87	11	7	35	50 F05	7	41.5	50	24	43.5	11	3	24.5	75	170	7.9	30	1.10
*1	✓ 25	24.2	19.1	41	60	105	11	7	35	50 F05	7	47	50	24	52.5	11	3	30	80.5	170	13	16	1.83
*1 1/4	✓ 32	30	21.4	50	72	122.5	11	7	35	50 F05	7	59.5	50	32	61.2	11	3	38	93	170	20.7	10	2.75
*1 1/2	✓ 40	38	21.4	55	86	138.5	15	9	55	70 F07	8	74	70	37	69.2	14	3	44.5	111	230	38.7	10	4.57
*2	✓ 50	49.5	25.7	70	111	166	15	9	55	70 F07	8	85	70	37	83	14	3	56	122	230	54	10	8.37

Flow Path Variations

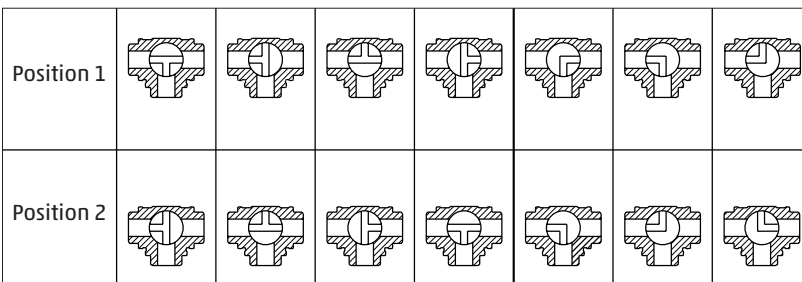

The flow paths are indicated by the markings on the spindle

Non-Return Valves

Connections: 3/8, 1/2, 3/4, 1, 1 1/4, 1 1/2, 2, 2 1/2, 3, 4
Brass & Stainless Steel

Suitable for a wide range of fluids.

Part Number: 100000* - Brass Valves

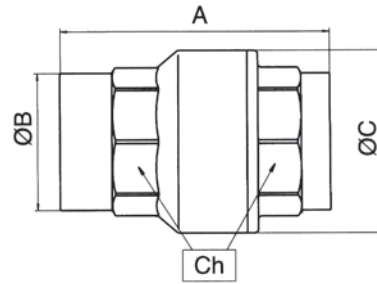
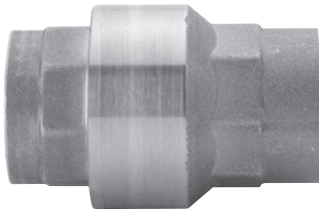

- ✓ Ex Stock
- ✎ UK Assembly
- ☎ Please Call Sales Office

Dimensions (mm) and Pressures

	DN	A	B	C	CH	Kv	PN	kg
*03 ✓	3/8	10	47	21.5	26.5	22	3.9	0.09
*04 ✓	1/2	15	59	25	34.5	25	5.2	0.14
*05 ✓	3/4	20	65	30.5	42	31	9.4	0.21
*06 ✓	1	25	75	37.5	49	38	14.5	0.32
*07 ✓	1 1/4	32	83	47.5	61	48	23.5	0.53
*08 ✓	1 1/2	40	89	53.5	73	54	33.5	0.75
*10 ✓	2	50	101.5	68	88	67	52	1.13
*12 ✓	2 1/2	65	121	82	111.5	83	84.3	2.00
*14 ✓	3	80	136	97.5	133	98	135.4	3.12
*18 ✓	4	100	158	127	163	128	193.2	5.64

Technical Data

Media

Suitable for air lines and generally for fluids compatible with materials used e.g. air, gas, oil, water etc.
(NOT RECOMMENDED FOR USE DIRECTLY ON OR ADJACENT TO COMPRESSORS)

Opening Pressure

20 - 25 millibar

Operating Pressure

3/8 to 3/4 - 40 bar
1 to 1 1/4 - 25 bar
1 1/2 to 2 - 16 bar
2 1/2 to 3 - 12 bar
4 - 10 bar

Operating Temperature

-20°C to +100°C

Materials

Body: Brass
Seals: NBR

Installation

In rigid pipework

Position

As indicators

Special Requests

For assistance, contact our technical office or your local Camozzi distributor.

Part Number: CRO* - Stainless Steel

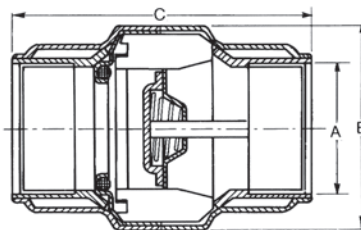

- ✓ Ex Stock
- ✎ UK Assembly
- ☎ Please Call Sales Office

Dimensions (mm) and Pressures

	A	B	C	PN	Weight (gm)
*1/2 ✓	38	64	16	95	
*3/4 ✓	45	72	16	142	
*1 ✓	53	88	16	197	
*1 1/4 ✓	62	99	16	320	
*1 1/2 ✓	78	117	16	400	
*2 ✓	85	115	16	676	
*2 1/2 ✓	106	127	16	1075	
*3 ✓	128	140	16	1630	
*4 ✓	163	167	16	2770	

Technical Data

Media

Suitable for a wide range of fluids including hard hot water, hydrocarbons, corrosive and abrasive liquids

Opening Pressure

0.03 BAR

Operating Pressure

Nominal working pressure (PN) in bar - see chart
Not suitable for Vacuum

Operating Temperature

-20°C to +150°C
(on request PTFE Seal -20°C to +200°C)

Materials

Metal parts: Stainless steel AISI 304, (316 stainless steel on request)
Seal: Viton

Special Requests

For assistance, contact our technical office or your local Camozzi distributor.

CAMOZZI AUTOMATION **MORE THAN JUST PNEUMATICS**

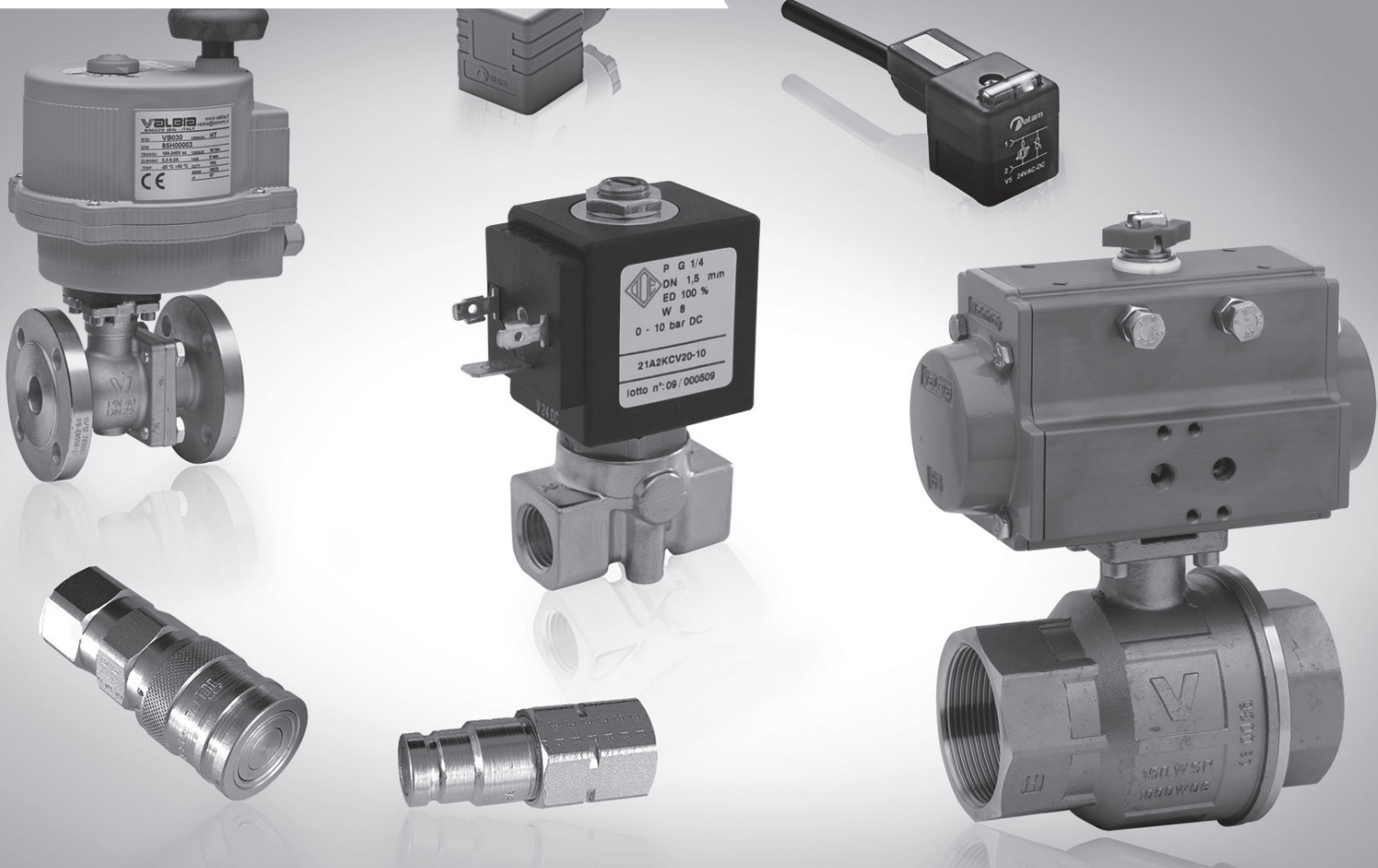

One Stop Fluid Power Shop

A complete range of fluid power products is available through the Camozzi sales office.

Camozzi supplies so much more than just pneumatics, proven by the fact that we've even changed our name to Camozzi Automation!

If you're looking to find an alternative product, why not try our rapid cross reference service. Just give us the part number you require an equivalent to and we'll save you time and find an alternative for you.



Camozzi Automation
A Camozzi Group Company

Pneumatic Solutions
Process Valves & Actuators
Hydraulic Components
Electrical DIN Connectors
Industrial Solenoid Valves

Camozzi Automation Ltd
The Fluid Power Centre
Watling Street, Nuneaton
Warwickshire, CV11 6BQ
024 7637 4114
askus@camozzi.co.uk
www.camozzi.co.uk
store.camozzi.co.uk

Process Valves and Actuation



1 Butterfly Valves

	Page
 Butterfly Valves Manual	297
 Butterfly Valves - Actuated	298







2 Actuated Two-Way Ball Valves

	Page
 Pneumatically Actuated Two-Way Brass Ball Valves	299
 Electrically Actuated Two-Way Brass Ball Valves	300
 Pneumatically Actuated Two-Way Stainless Steel Ball Valves	301
 Electrically Actuated Two-Way Stainless Steel Ball Valves	302

3 Actuated Three-Way Ball Valves

	Page
 Pneumatically Actuated Three-Way Brass Ball Valves	303
 Electrically Actuated Three-Way Brass Ball Valves	304

4 Industrial Solenoid Valves

	Page
 Solenoid Valves - Direct Acting	305
 Solenoid Valves - Servo Assisted	308
 Solenoid Valves - Coupled Diaphragm	310
 Automatic Drain Valve	311
 Solenoid Valves - Direct Acting Normally Closed Stainless Steel	312
 Solenoid Valves - Coupled Diaphragm Normally Closed Stainless Steel	313

5 Accessories

	Page
 Series NA NAMUR Valves	314

Butterfly Valves - Manual

Wafer Types 600104 & 600105

Wafer Butterfly Valve to suit PN16 and ANSI 150 flanges with Handle and Body made of Cast Iron. The Butterfly Valve series Eurofly Wafer and Lug have been manufactured to meet the industrial applications of water treatment, fire-fighting and plumbing plants. They can be used for all the applications where fluid regulation is required. The Seat construction is made with a rigid plastic ring covered with thick EPDM or Buna or Viton coating, depending on the media. This system offers a soft and reliable closure, a long cycling life and low torque. Due to the seat geometry it is particularly easy to replace.

Part Number: 600104* Cast Iron Disc / EPDM seat
600105* Stainless Steel Disc / EPDM seat



Also available with limit switch box

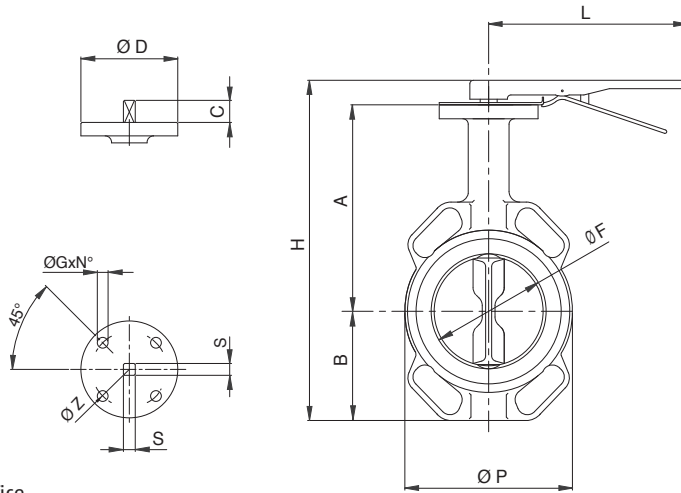

Technical Data

Media

Any application with media suitable to materials of construction

Maximum Operating Pressure

16 BAR

Operating Temperature

-10°C to +120°C EPDM

Flange Rating

PN16 / ANSI 150

Materials

Body: Cast Iron

Disc: 600105: Stainless Steel
600104: Cast Iron

Stem: Stainless Steel 416

Liner: EPDM

Lever: EN GJL 250

Special Requests

For assistance, contact our technical office or your local Camozzi distributor.

Additional Options



Available with Pneumatic or Electric Actuators



With limit switch box



Gearbox Operator

- ✓ Ex Stock
- 🔧 UK Assembly
- ☎ Please Call Sales Office

Dimensions (mm)																		
Size	DN	H	A	B	L	ØF	ØP	ØR	E	ØD	C	ØG	N°	ØZ	S	Kv	PN	Kg
*07	✓ 32	190	112	58	162	35	85	56	33	90	22	7/10	4	50/70	11	51.0	PN16 - ANSI 150	2.04
*08	✓ 40	204	112	70	162	41	95	68	33	90	22	7/10	4	50/70	11	68.0	PN16 - ANSI 150	2.30
*10	✓ 50	236.1	142.7	71.4	267	52.25	100	73.3	43	90	22	7/10	4	50/70	11	99.0	PN16 - ANSI 150	3.24
*12	✓ 65	255.2	155.4	77.8	267	64.05	120	86	46	90	22	7/10	4	50/70	11	169.0	PN16 - ANSI 150	3.88
*14	✓ 80	272.8	161.8	89	267	78.65	127	100.9	46	90	22	7/10	4	50/70	11	260.0	PN16 - ANSI 150	4.18
*18	✓ 100	302	178	102	267	104.15	161	132	52	90	22	10	4	70	14	516.0	PN16 - ANSI 150	5.36
*19	✓ 125	335.5	190.2	123	267	123.35	190	156	56	90	22	10	4	70	14	879.0	PN16 - ANSI 150	7.10
*20	✓ 150	365.2	205.2	138	267	155.85	215	185.4	56	90	22	10	4	70	14	1358.0	PN16 - ANSI 150	8.28
*21	✓ 200	439.5	237	168	358	202.55	268	235.2	60	150	34.5	12	4	102	17	2697.0	PN16 - ANSI 150	13.70
*77	✓ 250	509.8	268.3	207	358	250.55	325	289.4	68	150	34.5	12	4	102	22	4592.0	PN16 - ANSI 150	21.82
*78	✓ 300	586.5	308.5	243.5	358	301.65	375	341.2	78	150	34.5	14	4	125	27	7095.0	PN16 - ANSI 150	32.09
*97	✓ 350**	-	386	259	-	341.7	436	-	78	175	65	18	4	140	Ø28	10249	16	54.50
*98	✓ 400**	-	400	309	-	397.5	488	-	102	175	75	18	4	140	Ø38	14094	16	87.00
*	✓ 450**	-	422	327	-	448.4	536	-	114	175	75	18	4	140	Ø37.9	18666	16	101.50
*	✓ 500**	-	480	361	-	499	593	-	127	210	90	23	4	165	Ø45	24001	16	149.00
*	✓ 600**	-	562	459	-	600.1	820	-	151	210	100	23	4	165	Ø55.6	37080	16	240.00

DN32-40 valves only available with Stainless Steel Disc.

Butterfly Valves - Actuated

Actuated 'Wafer' Type Cast Iron

Cast Iron 'Wafer' Pattern Butterfly Valve with Cast Iron and Stainless Steel Disc options, fitted with Pneumatic Actuator. For Valve details refer to types 600104 and 600105 on page 297.

Part Number: 8P009700*
 8P010100*
 8P009800*
 8P010200*

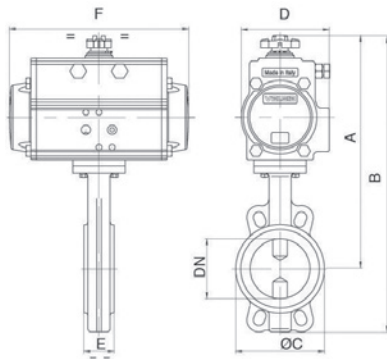

Technical Data

Media

Any application with media suitable to materials of construction

Maximum Operating Pressure

16 BAR

Flange Rating

PN16 / ANSI 150

Materials

For valve details refer to page 297

Additional Options

Limit switch boxes for open/closed position indication.
 Actuation fitting conditions.
 Fluid H₂O +20°C Actuation 6 bar.
 NAMUR solenoid valve.
 Actuator sizing conditions are based on Water service at 16 Bar g with a minimum air supply pressure of 5.5 Bar g

Special Requests

For assistance, contact our technical office or your local Camozzi distributor.

- ✓ Ex Stock
- 🔧 UK Assembly
- 📞 Please Call Sales Office

Valve Mounted on Double Acting Actuator.

Types 8P009700* } EN GJS 400 Disc
 EPDM Liner
 8P010100* } CF8M Disc
 EPDM Liner

Dimensions (mm)										
Size	DN	PN	A	B	ØC	D	E	F	ACT	
*07	32	16	224	282	85	71	33	141	DA52	
*08	40	16	224	294	95	71	33	141	DA52	
*10	50	16	255	326	100	71	43	141	DA52	
*12	65	16	267	345	120	71	46	141	DA52	
*14	80	16	281	370	127	81	46	164	DA63	
*18	100	16	315	417	161	95	52	210	DA75	
*19	125	16	341	464	190	106	56	241	DA85	
*20	150	16	355	493	215	106	56	241	DA85	
*21	200	16	434	602	268	137	60	333	DA115	
*77	250	16	482	689	325	148	68	372	DA125	
*78	300	16	541	784	375	164	78	435	DA140	

Valve Mounted on Single Acting Actuator.

Types 8P009800* } GGG 40 Disc
 EPDM Liner
 8P010200* } CF8M Disc
 EPDM Liner

Dimensions (mm)										
Size	DN	PN	A	B	ØC	D	E	F	ACT	
*07	32	16	231	290	85	81	33	164	SR63	
*08	40	16	235	305	95	81	33	164	SR63	
*10	50	16	266	338	100	81	43	164	SR63	
*12	65	16	279	357	120	81	46	164	SR63	
*14	80	16	312	401	127	106	46	241	SR85	
*18	100	16	328	430	161	106	52	241	SR85	
*19	125	16	354	477	190	123	56	275	SR100	
*20	150	16	398	536	215	137	56	333	SR115	
21	200	16	493	661	268	186	60	500	SR160	
77	250	16	524	731	325	186	68	500	SR160	
78	300	16	697	940	375	217	78	579	SR200	

Valve design may vary from type shown

DN32-40 valves only available with Stainless Steel Disc.



Also available in Lugged Pattern

Pneumatically Actuated Two-Way Brass Ball Valves

Full bore 2-way brass ball valve, (type 2500 page 289), with direct mount pneumatic actuator.

Not suitable for use with solvents.

Part Number: 8P007900* - Double Acting
8P008100* - Single Acting

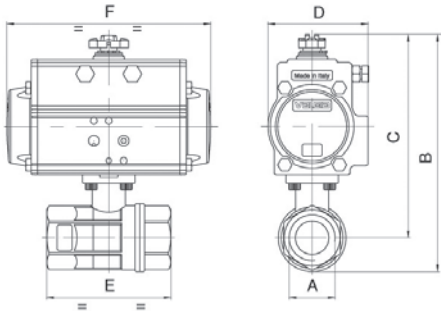

Technical Data

Media

Most non-corrosive liquids and gases including air, water, fuels and propane

Operating Pressure

Nominal working pressure (PN) in bar - see chart

Flow Rates

Flow rates stated in 2500 data sheet

Threads

DN - UNI EN 10226-1 Rp

Materials

Body: Brass, nickel plated
Ball: Brass, chrome plated
Seals: PTFE with Viton and EPDM 'O' Ring

Additional Options

Valve with NPTF thread.
Limit switch boxes for open/closed position indication.
Actuator sizing conditions are based on Water service at 16 Bar g with a minimum air supply pressure of 5.5 Bar

Special Requests

For assistance, contact our technical office or your local Camozzi distributor.

- ✓ Ex Stock
- 🔧 UK Assembly
- ☎ Please Call Sales Office

Valve Mounted on Double Acting Actuator. Types 8P007900

Dimensions (mm)										
Size	Thread	DN	PN	A	B	C	D	E	F	ACT
*02	1/4	8	40	1/4	115	98	45	67	110	DA32
*03	3/8	10	40	3/8	115	98	45	67	110	DA32
*04	1/2	15	40	1/2	115	98	45	67	110	DA32
*05	3/4	20	40	3/4	120	100	45	76	110	DA32
*06	1	25	40	1	135	111	45	90	110	DA32
*07	1 1/4	32	40	1 1/4	144	114	45	102	110	DA32
*08	1 1/2	40	40	1 1/2	203	166	71	114	141	DA52
*10	2	50	40	2	221	175	71	138	141	DA52
*12	2 1/2	65	25	2 1/2	259	202	81	165	164	DA63
*14	3	80	16	3	279	211	81	188	164	DA63
*18	4	100	16	4	345	262	106	225	241	DA85

Valve Mounted on Single Acting Actuator. Types 8P008100

Dimensions (mm)										
Size	Thread	DN	PN	A	B	C	D	E	F	ACT
*02	1/4	8	40	1/4	151	134	71	67	141	SR52
*03	3/8	10	40	3/8	151	134	71	67	141	SR52
*04	1/2	15	40	1/2	151	134	71	67	141	SR52
*05	3/4	20	40	3/4	156	136	71	76	141	SR52
*06	1	25	40	1	172	147	71	90	141	SR52
*07	1 1/4	32	40	1 1/4	180	151	71	102	141	SR52
*08	1 1/2	40	40	1 1/2	214	177	81	114	164	SR63
*10	2	50	40	2	232	186	81	138	164	SR63
*12	2 1/2	65	25	2 1/2	291	234	106	165	241	SR85
*14	3	80	16	3	311	243	106	188	241	SR85
*18	4	100	16	4	358	275	123	225	275	SR100



NAMUR solenoid valves



Limit switch box

Electrically Actuated Two-Way Brass Ball Valves

2-way full bore ball valve, (type 2500 page 289), threaded F/F with electric actuator, not suitable for use with solvents.

Part Number: 8E014***

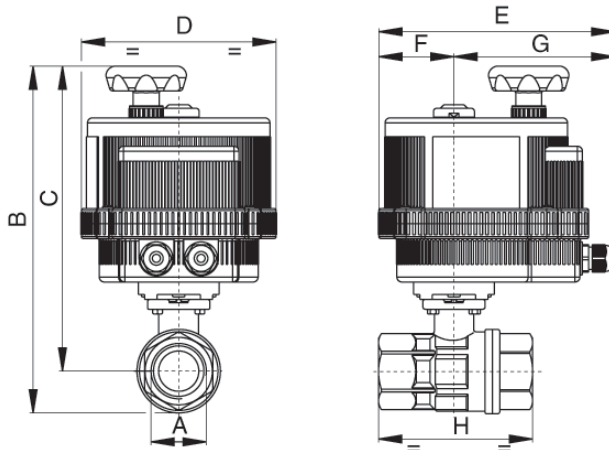

Technical Data

Media

Most non-corrosive liquids and gases including air, water, fuels and propane

Operating Pressure

Nominal working pressure (PN) in bar - see chart

Flow Rates

Flow rates stated in 2500 data sheet

Threads

DN - UNI EN 10226-1 Rp

Materials

Body: Brass, nickel plated
Ball: Brass, chrome plated
Seals: PTFE with Viton and EPDM 'O' Ring

Additional Options

Modulating options:

4 - 20mA or 0 - 10v

Battery Block for safety operation

Modulating complete with Battery Block for safety operation

Special Requests

For assistance, contact our technical office or your local Camozzi distributor.

- ✓ Ex Stock
- 🔧 UK Assembly
- 📞 Please Call Sales Office

Voltage Supply Order Code			
For Mod. VB015	12V AC/DC **001	24V AC/DC **002	100-240V AC **004
For Mod. VB030-350	12V DC **001		

Dimensions (mm)											
Size	Thread	DN	PN	B	C	D	E	F	G	H	Elect. ACT
*02	1/4	8	40	192	175	123	164	43	121	67	VB 015
*03	3/8	10	40	192	175	123	164	43	121	67	VB 015
*04	1/2	15	40	192	175	123	164	43	121	67	VB 015
*05	3/4	20	40	197	177	123	164	43	121	76	VB 015
*06	1	25	40	213	188	123	164	43	121	90	VB 015
*07	1 1/4	32	40	221	191	123	164	43	121	102	VB 015
*08	1 1/2	40	40	289	252	157	191	61	130	114	VB 030
*10	2	50	40	308	262	157	191	61	130	138	VB 030
*12	2 1/2	65	25	360	303	185	215	68	147	165	VB 060
*14	3	80	16	382	314	185	215	68	147	188	VB 060
*18	4	100	16	435	352	211	237	84	153	225	VB 110

See full catalogue or catalogue.camozzi.com for all dimensions.
For technical advice contact our sales office or your local Camozzi distributor.

Pneumatically Actuated Two-Way Stainless Steel Ball Valve

Full bore 2-way Stainless Steel Ball Valve (Type 703000 Page 290) with Direct Mount Pneumatic Actuator.

Part Number: 8P000300* - Double Acting
8P000400* - Single Acting

PROCESS VALVES AND ACTUATION

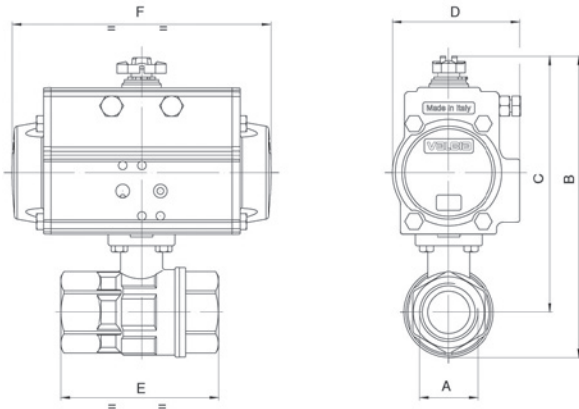
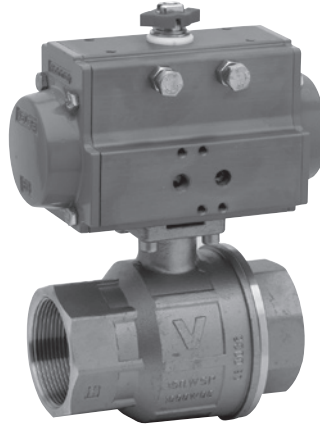

Technical Data

Operating Conditions
Fluid water at +20°C

Media
Any application with media suitable to stainless steel (materials of construction)

Operating Pressure
Nominal working pressure (PN) in bar - see chart

Operating Temperature
-20°C to +160°C

Flow Rates
Flow rates stated in data sheet 703000

Threads
ISO 7/1 UNI EN 10226/1 - Rp

Materials
Body: CF8M
Ball: CF8M
Seals: PTFE with Viton 'O' Ring
Stem: AISI 316

Additional Options
Valve with NPTF threads. Limit switchbox for open and close position indicator.

Actuator sizing conditions are based on Water service at 16 Bar g with a minimum air supply pressure of 5.5 Bar g
NAMUR solenoid valve

Special Requests
For assistance, contact our technical office or your local Camozzi distributor.

- ✓ Ex Stock
- 🔧 UK Assembly
- ☎ Please Call Sales Office

Valve Mounted on Double Acting Actuator. Types 8P000300

Dimensions (mm)											
Size	Thread	DN	PN	A	B	C	D	E	F	ACT	
*04	1/2	15	64	1/2	115	98	45	67	110	DA 32	
*05	3/4	20	64	3/4	121	100	45	78	110	DA 32	
*06	1	25	64	1	136	110	45	90	110	DA 32	
*07	1 1/4	32	64	1 1/4	146	113	45	100	110	DA 32	
*08	1 1/2	40	64	1 1/2	203	165	71	112	141	DA 52	
*10	2	50	64	2	223	174	71	135	141	DA 52	
*14	3	80	25	3	306	234	95	180	210	DA 75	

Valve Mounted on Single Acting Actuator. Types 8P000400

Dimensions (mm)											
Size	Thread	DN	PN	A	B	C	D	E	F	ACT	
*04	1/2	15	64	1/2	152	134	71	67	141	SR 52	
*05	3/4	20	64	3/4	157	136	71	78	141	SR 52	
*06	1	25	64	1	172	146	71	90	141	SR 52	
*07	1 1/4	32	64	1 1/4	182	150	71	100	141	SR 52	
*08	1 1/2	40	64	1 1/2	215	177	81	112	164	SR 63	
*10	2	50	64	2	235	186	81	135	164	SR 63	
*14	3	80	25	3	333	260	123	180	275	SR 100	



NAMUR solenoid valves



Limit switch box

Electrically Actuated Two-Way Stainless Steel Ball Valves

Full bore 2-way Stainless Steel Ball Valve (Type 703000 Page 290) with Direct Mount Electric Actuator.

Part Number: 8E003***

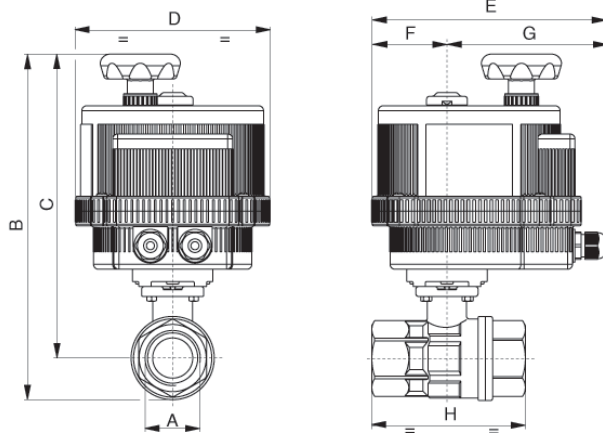

Technical Data

Media

Any application with media suitable to stainless steel (materials of construction)

Operating Pressure

Nominal working pressure (PN) in bar - see chart

Operating Temperature

-20°C to +160°C

Flow Rates

Flow rates stated in data sheet 703000

Threads

ISO 7/1 - UNI EN 10226/1 - Rp

Materials

Body: CF8M

Ball: CF8M

Seals: PTFE with Viton 'O' Ring

Stem: AISI 316

Additional Options

Modulating options:

4 - 20mA or 0 - 10v

Battery Block for safety operation

Modulating complete with Battery Block for safety operation

Special Requests

For assistance, contact our technical office or your local Camozzi distributor.

PROCESS VALVES AND ACTUATION

- ✓ Ex Stock
- 🔧 UK Assembly
- ☎ Please Call Sales Office

Voltage Supply Order Code			
For Mod. VB015	12V AC/DC **001	24V AC/DC **002	100-240V AC **004
For Mod. VB030-350	12V DC **001		

Dimensions (mm)											
Size	Thread	DN	PN	B	C	D	E	F	G	H	Elect. ACT
*04	1/2	15	64	192	175	123	164	43	121	67	VB 015
*05	3/4	20	64	198	177	123	164	43	121	78	VB 015
*06	1	25	64	213	187	123	164	43	121	90	VB 015
*07	1 1/4	32	64	223	190	123	164	43	121	100	VB 015
*08	1 1/2	40	64	290	251	157	191	61	130	112	VB 030
*10	2	50	64	309	261	157	191	61	130	135	VB 030
14	3	80	25	390	318	185	215	68	147	180	VB 060

*Special Version

See full catalogue or catalogue.camozzi.com for all dimensions.
For technical advice contact our sales office or your local Camozzi distributor.

Pneumatically Actuated Three-Way Brass Ball Valves

Full Bore 3-way Brass Ball Valve (Type 3500 'T' port and 3600 'L' port page 293) with Direct Mount Pneumatic Actuator

Full bore 3-way Brass Ball Valve, L port or T port design with Direct Mount Pneumatic Actuator. NPT thread version also available. Pressure rating up to 30 BAR according to size.

Part Number: 8P008300* (double acting T Ported)
8P008400* (double acting L Ported)
8P008500* (single acting T Ported)
8P008600* (single acting L Ported)

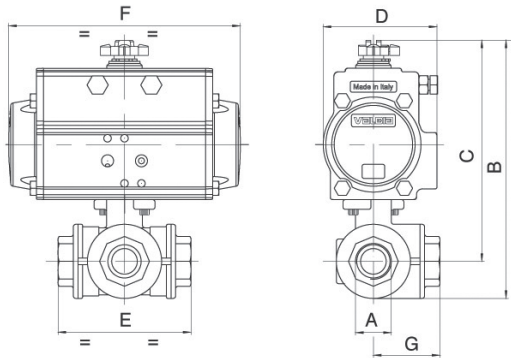
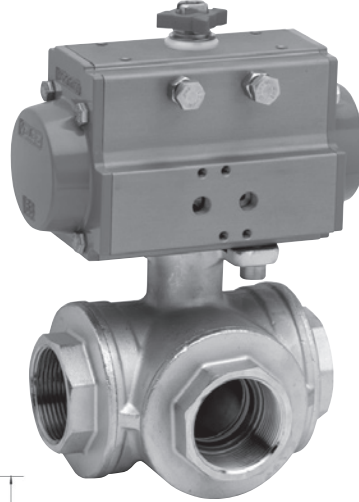

Technical Data

Media

Most non-corrosive liquids and gases including air, water, fuels and propane

Operating Pressure

Nominal working pressure (PN) in bar - see chart

Operating Temperature

-20°C to +160°C

Threads

DN - UNI EN 10226-1 Rp

Materials

Body: Brass, nickel plated
Ball: Brass, chrome plated
Seals: PTFE with Viton and EPDM 'O' Ring

Additional Options

Valve with NPTF thread.
Limit switch boxes for open/closed position indication.
NAMUR solenoid valves.
Actuator sizing conditions are based on Water service at 16 Bar g with a minimum air supply pressure of 5.5 Bar g

Special Requests

For assistance, contact our technical office or your local Camozzi distributor.

- ✓ Ex Stock
- 🔧 UK Assembly
- 📞 Please Call Sales Office

Valve Mounted on Double Acting Actuator. Types 8P008300-T 8P008400-L

Dimensions (mm)												
Size	Thread	DN	PN	A	B	C	D	E	F	G	ACT	
*02	1/4	8	30	1/4	113	96	45	67	110	34	DA32	
*03	3/8	10	30	3/8	113	96	45	67	110	34	DA32	
*04	1/2	15	30	1/2	118	98	45	77	110	39	DA32	
*05	3/4	20	30	3/4	167	143	71	87	141	44	DA52	
*06	1	25	16	1	179	149	71	105	141	53	DA52	
*07	1 1/4	32	10	1 1/4	197	161	71	123	141	62	DA52	
*08	1 1/2	40	10	1 1/2	230	187	81	139	164	70	DA63	
*10	2	50	10	2	272	216	95	166	210	83	DA75	

Valve Mounted on Single Acting Actuator. Types 8P008500-T 8P008600-L

Dimensions (mm)												
Size	Thread	DN	PN	A	B	C	D	E	F	G	ACT	
*02	1/4	8	30	1/4	149	132	71	67	141	34	SR52	
*03	3/8	10	30	3/8	149	132	71	67	141	34	SR52	
*04	1/2	15	30	1/2	154	134	71	77	141	39	SR52	
*05	3/4	20	30	3/4	179	155	81	87	164	44	SR63	
*06	1	25	16	1	190	160	81	105	164	53	SR63	
*07	1 1/4	32	10	1 1/4	209	173	81	123	164	62	SR63	
*08	1 1/2	40	10	1 1/2	262	219	106	139	241	70	SR85	
*10	2	50	10	2	299	243	123	166	275	83	SR100	



NAMUR solenoid valves



Limit switch box

Electrically Actuated Three-Way Brass Ball Valves

Full Bore 3-way Brass Ball Valve (Type 3500 'T' port and 3600 'L' port page 293) with Direct Mount Electric Actuator

Part Number: 8E028** *(T)
8E029** *(L)



Technical Data

Media

Most non-corrosive liquids and gases including air, water, fuels and propane.

Operating Pressure

Nominal working pressure (PN) in bar - see chart

Flow Rates

Flow rates stated in data sheet
3500/3600

Threads

ISO 7/1 - UNI EN 10226/1 - Rp

Materials

Body: Brass, Nickel-plated
Balls: Brass, hard chromed
Seal: PTFE and Viton and EPDM 'O' Ring

Additional Options

Modulating options:
4 - 20mA or 0 - 10v
Modulating complete with Battery Block for safety operation

Special Requests

For assistance, contact our technical office or your local Camozzi distributor.

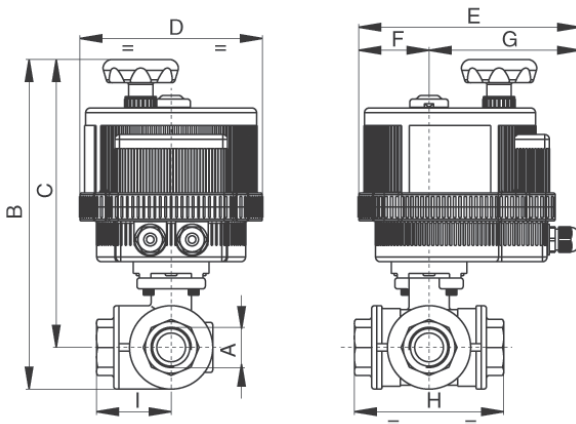

- ✓ Ex Stock
- 🔧 UK Assembly
- ☎ Please Call Sales Office

Voltage Supply Order Code			
For Mod. VB015	12V AC/DC **001	24V AC/DC **002	100-240V AC **004
For Mod. VB030-350	12V DC **001		

Dimensions (mm)												
Size	Thread	DN	PN	B	C	D	E	F	G	H	I	Elect. ACT
*02	1/4	8	30	190	173	123	164	43	121	67	34	VB 015
*03	3/8	10	30	190	173	123	164	43	121	67	34	VB 015
*04	1/2	15	30	195	175	123	164	43	121	77	39	VB 015
*05	3/4	20	30	208	184	123	164	43	121	87	44	VB 015
*06	1	25	16	265	235	157	191	61	130	105	53	VB 030
*07	1 1/4	32	10	284	248	157	191	61	130	123	62	VB 030
*08	1 1/2	40	10	332	289	185	215	68	147	139	70	VB 060
*10	2	50	10	356	300	185	215	68	147	166	83	VB 060

See full catalogue or catalogue.camozzi.com for all dimensions.
For technical advice contact our sales office or your local Camozzi distributor.

Solenoid Valves - Direct Acting

Connections: 1/8, 1/4

Operation: Direct Acting 2/2 NC

PROCESS VALVES AND ACTUATION

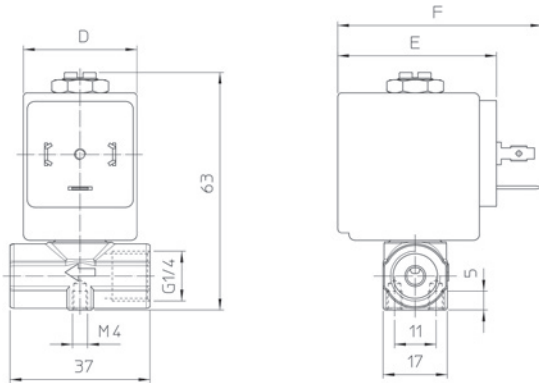

Technical Data

Type of Construction

Direct - Acting
Normally closed only

Line Media

Non-aggressive liquids and gases, ie air, oil, water

Operating Pressure

See table

Operating Temperature

Ambient: -10°C to +55°C
Fluid: -10°C to +140°C

Threads

BSPG GAS Parallel ISO 228/1

Materials

Body: Brass
Other Parts: Stainless steel
Seals: Viton

Mounting

M4 mounting holes in body

Standard Voltages

12VDC 24VDC
24VAC 110VAC 230VAC (50Hz)

Protection Rating

IP65 with connector
- see pages 134-137

Power Consumption

DC: 8W
AC: Working 14 VA In rush 25 VA

Options

Different voltages
Bi-stable coils

Special Requests

For assistance, contact our technical office or your local Camozzi distributor.

- ✓ Ex Stock
- ✎ UK Assembly
- 📞 Please Call Sales Office

Connection Sizes	D	E	F
1/8 - 1/4	30	42	54

2/2 Direct - Acting Solenoid Valves					
	Size	Orifice Ø mm	Pressure Range (bar)		
			AC	DC	
21TG1KROV17	✓ 1/8	1.7	0 - 30	0 - 20	
21TG1KROV22	✓ 1/8	2.2	0 - 20	0 - 15	
21TG1KROV28	✓ 1/8	2.8	0 - 14	0 - 10	
21TG1KROV40	✓ 1/8	4.0	0 - 6	0 - 3	
21TG2KROV17	✓ 1/4	1.7	0 - 30	0 - 20	
21TG2KROV22	✓ 1/4	2.2	0 - 20	0 - 15	
21TG2KROV28	✓ 1/4	2.8	0 - 14	0 - 10	
21TG2KROV40	✓ 1/4	4.0	0 - 6	0 - 3	

*Please specify coil voltage required when ordering.
Price excludes coil - please order separately (see below).

8 Watt Coils		
		Voltage
BDA08012CS	✓	12V DC
BDA08024CS	✓	24V DC
BDA08024DS	✓	24V AC
BDA08110DS	✓	110V AC
BDA08223DS	✓	230V AC



For Standard Connectors

See pages 134-135

Solenoid Valves - Direct Acting

Connections: 1/4

Operation: Direct Acting 2/2 NC or NO

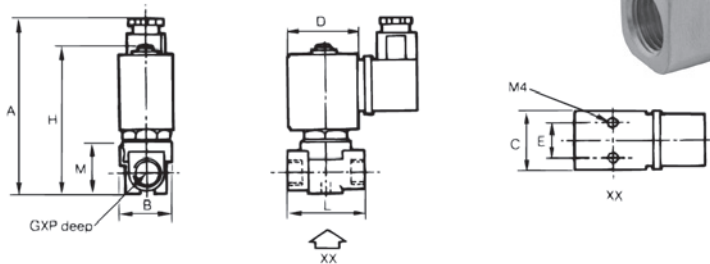
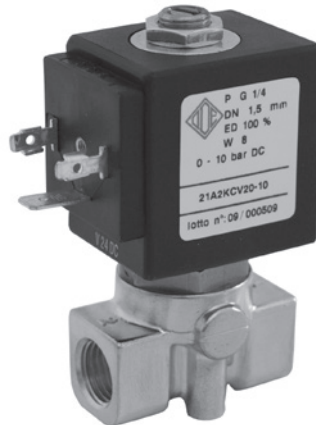

- ✓ Ex Stock
- ✂ UK Assembly
- ☎ Please Call Sales Office

Connection Size	A	B	C	D	E	F	G	M	P
1/4	91	28	52	55	16	78	41	28	7

2/2 Direct - Acting Solenoid Valves (For use with 8W Coil)							
	Orifice Size	Ø mm	Pressure Range (bar) Normally Closed		Pressure Range (bar) Normally Open		
			AC	DC	AC	DC	
21A2KV25	✓	1/4	2.5	0 - 14	0 - 9	-	-
21A2ZV25	✓	1/4	2.5	-	-	0 - 14	0 - 14
21A2KV30	✓	1/4	3.0	0 - 10	0 - 6	-	-
21A2ZV30	✓	1/4	3.0	-	-	0 - 10	0 - 10

2/2 Direct - Acting Solenoid Valves (For use with 12W Coil)							
	Size	Orifice Ø mm	Pressure Range (bar) Normally Closed		Pressure Range (bar) Normally Open		
			AC	DC	AC	DC	
21A2KV25	✓	1/4	2.5	0 - 30	0 - 25	-	-
21A2ZV25	✓	1/4	2.5	-	-	0 - 17	0 - 17
21A2KV30	✓	1/4	3.0	0 - 25	0 - 18	-	-
21A2ZV30	✓	1/4	3.0	-	-	0 - 15	0 - 15

Please specify coil voltage required when ordering. Price excludes coil - please order separately (see below).

8 and 12 Watt Coils			
		Voltage	Watt
BDA08012CS	✓	12V DC	8W
BDA08024CS	✓	24V DC	8W
BDA08024DS	✓	24V AC	8W
BDA08110DS	✓	110V AC	8W
BDA08223DS	✓	230V AC	8W
UDA12012CS	✓	12V DC	12W
UDA12024CS	✓	24V DC	12W
UDA12024AS	✓	24V AC	12W
UDA12110DS	✓	110V AC	12W
UDA12230AS	✓	230V AC	12W

Technical Data
Type of Construction
 Direct - Acting
 Normally closed or normally open

Line Media
 Non-aggressive liquids and gases, ie air, oil, water

Operating Pressure
 See table

Operating Temperature
 Ambient: -10°C to +55°C
 Fluid: -10°C to +140°C

Threads
 BSPP GAS Parallel ISO 228/1

Materials
 Body: Brass
 Other Parts: Stainless steel
 Seals: Viton

Mounting
 M4 mounting holes in body

Standard Voltages
 12VDC 24VDC
 24VAC 110VAC 230VAC (50Hz)

Protection Rating
 IP65 with connector
 - see pages 134-137

Power Consumption
 DC: 8W
 AC: Working 14 VA In rush 25 VA
 DC:12W
 AC: Working 35 VA In rush 25 VA

Options
 Different voltages
 Bi-stable coils
 Different seals

Special Requests
 For assistance, contact our technical office or your local Camozzi distributor.



For Moulded Connectors
 See pages 136-137

Solenoid Valves - Direct Acting

Connections: 1/8, 1/4

Operation: Direct Acting 3/2 NC

PROCESS VALVES AND ACTUATION

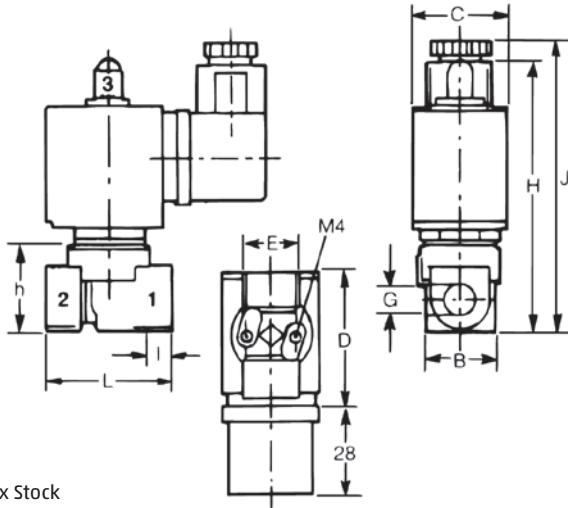

- ✓ Ex Stock
- ✎ UK Assembly
- © Please Call Sales Office

Connection Size B	C	D	E	h	H	I	J	L
1/8 - 1/4	28	31	42	16	28	88	7	92

Technical Data

Type of Construction

Direct - Acting
Normally closed

Line Media

Non-aggressive liquids and gases, ie air, oil, water

Operating Pressure

See table

Operating Temperature

Ambient: -10°C to +55°C
Fluid: -10°C to +140°C

Threads

BSPG GAS Parallel ISO 228/1

Materials

Body: Brass
Other Parts: Stainless steel
Seals: Viton

Mounting

M4 mounting holes in body

Standard Voltages

12VDC 24VDC
24VAC 110VAC 230VAC (50Hz)

Protection Rating

IP65 with connector
- see pages 134-137

Power Consumption

DC: 8W
AC: Working 14 VA In rush 25 VA
Supply: 2 Output: 1 Exhaust: 3

Options

Different voltages
Bi-stable coils
Normally open version

Special Requests

For assistance, contact our technical office or your local Camozzi distributor.

3/2 Direct - Acting Solenoid Valves

		Size	Orifice	Pressure Range (bar)	
			Ø mm	AC	DC
31A3AV20	✓	1/8	2.0 (2.5)	10	10
31A3AV25	✓	1/8	2.5 (2.5)	6	6
31A2AV20	✓	1/4	2.0 (2.5)	10	10
31A2AV25	✓	1/4	2.5 (2.5)	6	6
31A2AV30	✓	1/4	3.0 (2.5)	5	5

Please specify coil voltage required when ordering.
Price excludes coil - please order separately (see below).

8 Watt Coils

		Voltage
BDA08012CS	✓	12V DC
BDA08024CS	✓	24V DC
BDA08024DS	✓	24V AC
BDA08110DS	✓	110V AC
BDA08223DS	✓	230V AC



For Moulded Connectors

See pages 136-137

Solenoid Valves - Servo Assisted

Connections: 3/8, 1/2, 3/4

Operations: Servo assisted 2/2 NC

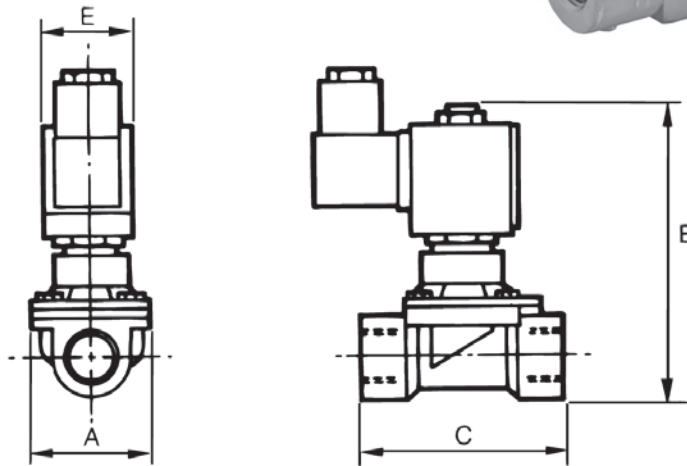

Technical Data

Type of Construction

Servo - Assisted
Normally closed only

Line Media

Non-aggressive liquids and gases, ie air, oil, water

Operating Pressure

See table

Operating Temperature

Ambient: -10°C to +55°C
Fluid: -10°C to +140°C

Threads

BSPP GAS Parallel ISO 228/1

Materials

Body: Brass
Other Parts: Stainless steel
Seals: Viton

Mounting

Body can be drilled for mounting

Standard Voltages

12VDC 24VDC
24VAC 110VAC 230VAC (50Hz)

Protection Rating

IP65 with connector
- see pages 134-137

Power Consumption

DC: 8W
AC: Working 14 VA In rush 25 VA
DC:12W
AC: Working 25 VA In rush 35 VA

Options

Different voltages
Bi-stable coils
Different seals

Special Requests

For assistance, contact our technical office or your local Camozzi distributor.

- ✓ Ex Stock
- ✎ UK Assembly
- ☎ Please Call Sales Office

2/2 Servo - Assisted Solenoid Valves		Dimensions					Pressure Range (bar)	
		Size	A	B	C	E	AC	DC
21H7KV120	✓	3/8	40	92	50	30	0.1 - 20	0.1 - 10
21H8KV120	✓	1/2	40	92	50	30	0.1 - 20	0.1 - 10
21H9KV180	✓	3/4	50	96	35	30	0.1 - 16	0.1 - 16 (12 watt coil only)

Please specify coil voltage required when ordering.
Price excludes coil - please order separately (see below).

8 and 12 Watt Coils			
		Voltage	Watt
BDA08012CS	✓	12V DC	8W
BDA08024CS	✓	24V DC	8W
BDA08024DS	✓	24V AC	8W
BDA08110DS	✓	110V AC	8W
BDA08223DS	✓	230V AC	8W
UDA12012CS	✓	12V DC	12W
UDA12024CS	✓	24V DC	12W
UDA12024AS	✓	24V AC	12W
UDA12110DS	✓	110V AC	12W
UDA12230AS	✓	230V AC	12W



For Standard Connectors

See pages 134-135

Solenoid Valves - Servo Assisted

Connections: 3/8, 1/2, 3/4, 1, 1 1/4, 1 1/2, 2

Operations: Servo Assisted 2/2 NC or NO

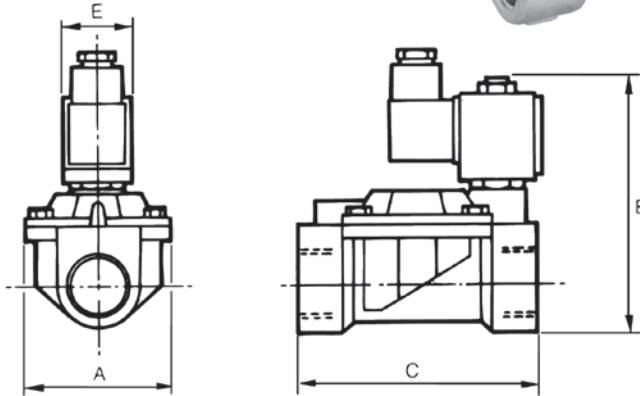

Technical Data

Type of Construction

Servo - Assisted
Normally closed or normally open

Line Media

Non-aggressive liquids and gases, ie air, oil, water

Operating Pressure

See table

Operating Temperature

Ambient: -10°C to +55°C
Fluid: -10°C to +140°C

Threads

BSPP GAS Parallel ISO 228/1

Materials

Body: Brass
Other Parts: Stainless steel
Seals: Viton

Mounting

Normally in fixed pipework

Standard Voltages

12VDC 24VDC
24VAC 110VAC 230VAC
(50Hz)

Protection Rating

IP65 with connector
- see pages 134-137

Power Consumption

DC: 8W
AC: Working 14 VA In rush 25 VA

Options

Different voltages
Bi-stable coils
Different seals

Special Requests

For assistance, contact our technical office or your local Camozzi distributor.

- ✓ Ex Stock
- 🔧 UK Assembly
- 📞 Please Call Sales Office

2/2 Servo - Assisted Solenoid Valves

		Size	Orifice Ø mm	Dimensions				Pressure Range (bar)	
				A	B	C	E	AC	DC
21WA3KOV130	✓	3/8	13	40	97	60	30	0.2 - 16	0.2 - 16
21WA3ZOV130	✓	3/8	13	40	97	60	30	0.2 - 16	0.2 - 16
21WA4KOV130	✓	1/2	13	40	97	66	30	0.2 - 16	0.2 - 16
21WA4ZOV130	✓	1/2	13	40	97	66	30	0.2 - 16	0.2 - 16
21W3KV190	✓	3/4	19	65	105	104	30	0.2 - 16	0.2 - 16
21W3ZV190	✓	3/4	19	65	105	104	30	0.2 - 16	0.2 - 16
21W4KV250	✓	1	25	65	112	104	30	0.2 - 16	0.2 - 16
21W4ZV250	✓	1	25	65	112	104	30	0.2 - 16	0.2 - 16
21W5KV350	✓	1 1/4	35	98	125	144	30	0.2 - 10	0.2 - 10
21W5ZV350	✓	1 1/4	35	98	125	144	30	0.2 - 10	0.2 - 10
21W6KV400	✓	1 1/2	40	98	125	144	30	0.2 - 10	0.2 - 10
21W6ZV400	✓	1 1/2	40	98	125	144	30	0.2 - 10	0.2 - 10
21W7KV500	✓	2	50	118	141	172	30	0.2 - 10	0.2 - 10
21W7ZV500	✓	2	50	118	141	172	30	0.2 - 10	0.2 - 10

K = Normally Closed (NC), Z = Normally Open (NO)

Please specify coil voltage required when ordering. Price excludes coil - please order separately (see below).

8 Watt Coils

		Voltage
BDA08012CS	✓	12V DC
BDA08024CS	✓	24V DC
BDA08024DS	✓	24V AC
BDA08110DS	✓	110V AC
BDA08223DS	✓	230V AC



For Moulded Connectors

See pages 136-137

Solenoid Valves - Coupled Diaphragm

Connections: 3/8, 1/2, 3/4, 1, 3/4, 1, 1 1/2
 Operations: Coupled Diaphragm 2/2 NC
 Operates from zero pressure

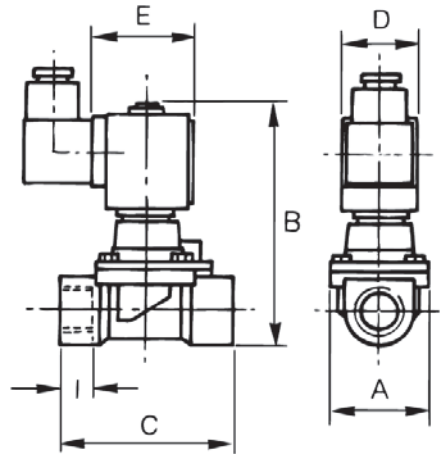

Technical Data

Type of Construction
 Coupled diaphragm
 Normally closed only

Line Media

Non-aggressive liquids and gases, ie air, oil, water

Operating Pressure
 See table

Operating Temperature
 Ambient: -10°C to +55°C
 Fluid: -10°C to +140°C

Threads
 BSPP GAS Parallel ISO 228/1

Materials
 Body: Brass
 Other Parts: Stainless steel
 Seals: Viton

Mounting
 Normally in fixed pipework. 3/8 and 1/2 only can be drilled for mounting. Brackets available for larger sizes on request

Standard Voltages
 12VDC 24VDC
 24VAC 110VAC 230VAC (50Hz)

Protection Rating
 IP65 with connector
 - see pages 134-137

Power Consumption
 DC: 8W
 AC: Working 14 VA In rush 25 VA
 DC: 12W
 AC: Working 35 VA In rush 25 VA
 DC: 14W
 AC: Working 43 VA In rush 27 VA

Options
 Different voltages

Special Requests
 For assistance, contact our technical office or your local Camozzi distributor.

- ✓ Ex Stock
- ✎ UK Assembly
- ☎ Please Call Sales Office

2/2 Servo - Assisted Solenoid Valves												
		Orifice		Dimensions					Coil		Pressure Range (bar)	
		Size	mm	A	B	C	D	E	watts	AC	DC	
21H11KOV120	✓	3/8	12	40	99	50	30	42	8	0 - 16	0 - 1.5	
	✓	3/8	12	40	99	50	30	42	12	0 - 20	0 - 6	
	✓	3/8	12	40	99	50	52	55	14	0 - 20	0 - 15	
21H12KOV120	✓	1/2	12	40	99	50	30	42	8	0 - 16	0 - 1.5	
	✓	1/2	12	40	99	50	30	42	12	0 - 20	0 - 6	
	✓	1/2	12	40	99	50	52	55	14	0 - 20	0 - 15	
21HF5KOV200	✓	3/4	20	65	103	104	52	55	8	0 - 16	0 - 6	
	✓	3/4	20	65	103	104	52	55	12	0 - 16	0 - 16	
21HF6KOV250	✓	1	25	65	110	104	52	55	8	0 - 16	0 - 5	
	✓	1	25	65	110	104	52	55	12	0 - 16	0 - 16	
21HF8KOV400	✓	1 1/2	40	94	130	128	52	55	14	0 - 16	0 - 6	
	✓	1 1/2	40	94	130	128	52	55	12	0 - 16	-	

Please specify coil voltage required when ordering. Price excludes coil - please order separately (see below).

		8 Watt Coils	12 Watt Coils	14 Watt Coils
Voltage				
12V DC	✓	BDA08012CS	UDA12012CS	GDH14012CS
24V DC	✓	BDA08024CS	UDA12024CS	GDH14024CS
24V AC	✓	BDA08024DS	UDA12024AS	GDH14024AS
110V AC	✓	BDA08110DS	UDA12110DS	GDH14110AS
230V AC	✓	BDA08223DS	UDA12230AS	GDH14223DS



For Standard Connectors
 See pages 134-135

PROCESS VALVES AND ACTUATION

Automatic Drain Valve

PROCESS VALVES AND ACTUATION

- Simple to install
- Long life
- Minimum maintenance
- Manual test facility
- Solid state timer
- Variable discharge times
- LED indicators showing operational status
- Timer can be wired with an AC or DC supply
- CE tested

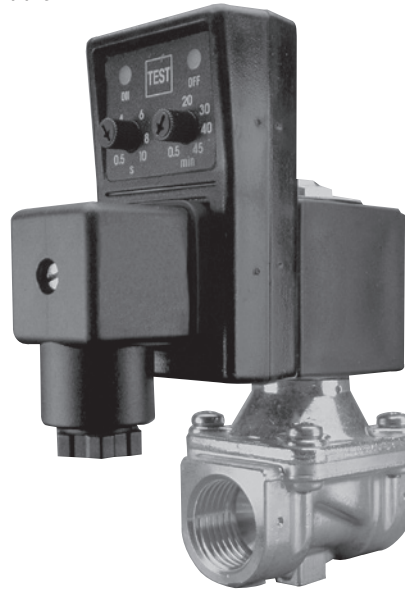

Technical Data
Type of Construction
 Servo - Assisted
 Normally closed only

Line Media
 Non-aggressive liquids and gases, ie air, oil, water

Operating Pressure
 0.1 - 16 bar

Operating Temperature
 -10°C to +90°C

Threads
 BSPP GAS Parallel ISO 228/1

Materials
 Body: Brass
 Other Parts: Stainless steel
 Seals: Viton

Mounting
 Contact sales office for details.

Standard Voltages
 24VDC 24VAC
 110VAC 230VAC (50Hz)

Connection Size
 3/8

Times (variable)
 Discharge: 0.5 - 10 secs.
 Interval: 0.5 - 45 mins

Protection Rating
 IP65 with connector
 - see pages 134-137

Options
 Different voltages
 Different connection sizes

Special Requests
 For assistance, contact our technical office or your local Camozzi distributor.

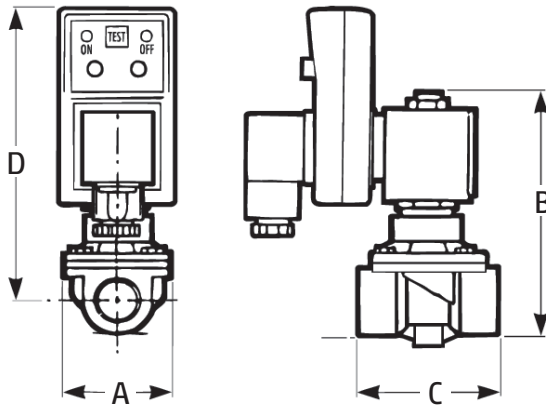

- ✓ Ex Stock
- 🔧 UK Assembly
- ☎ Please Call Sales Office

Dimensions			
A	B	C	D
40	75	40	120

Automatic Drain Valve		
D50	✓	3/8 (plus voltage)

Solenoid Valves - Direct Acting Normally Closed Stainless Steel

Connections: 1/8

Operation: 2 way normally closed
3 way normally closed

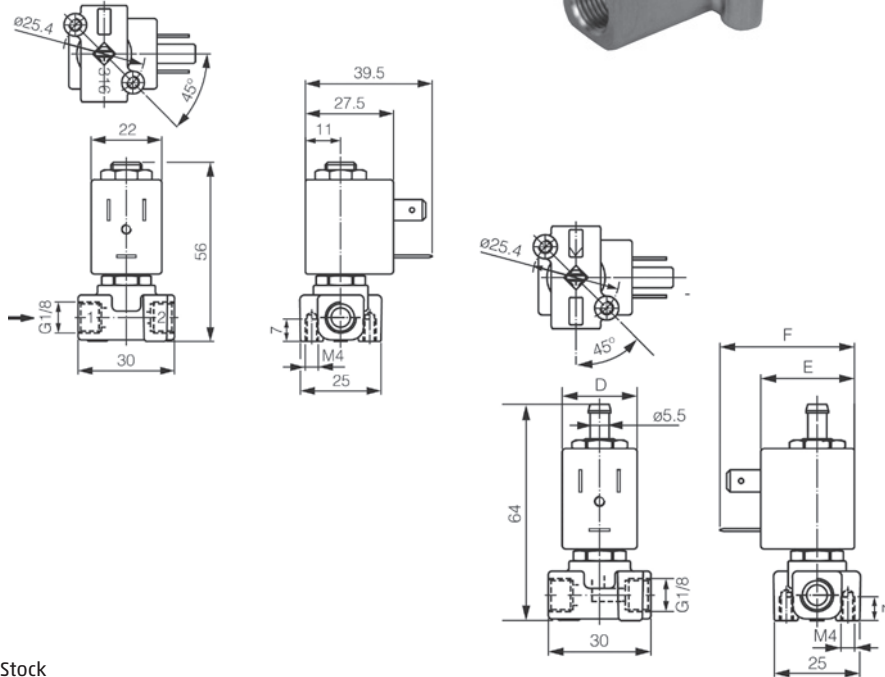
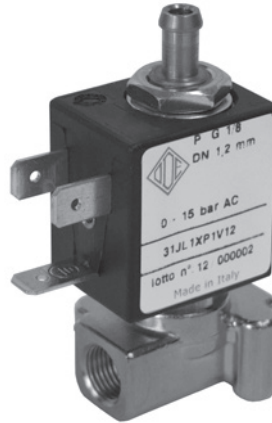

Technical Data

Type of Construction
Direct Acting, normally closed

Line Media
Air, oil, water, gas

Operating Pressure
See table

Operating Temperature
Ambient: -10°C to +60°C
Fluid: -10°C to +140°C

Threads
BSPP GAS Parallel ISO 228/1

Materials
Body: 316 Stainless Steel
Plunger: 306 Stainless steel
Seals: Viton

Mounting
M4

Standard Voltages
12v DC 24v DC
24v AC 110v AC 230v AC

Protection Rating
IP65 with connector
- see pages 134-137

Power Consumption
See table

Special Requests
For assistance, contact our technical office or your local Camozzi distributor.

- ✓ Ex Stock
- ✂ UK Assembly
- ☎ Please Call Sales Office

		Orifice			Pressure Range (bar)			
		Size	mm	Watt	Min	AC	DC	Kv
21JL1R1V12	⊘	1/8	1.2	5	0	25	12	0.06
21JL1R1V23	⊘	1/8	2.3	5	0	18	8	0.126
31JL1XP1V12	⊘	1/8	2.3	5	0	15	-	0.045

Coil Type	Power Absorption			Dimensions mm		
	W	Hold VA~	Inrush VA~	D	E	F
L	5	10	15	22	27.5	39.5



For Standard Connectors
See pages 134 and 135

PROCESS VALVES AND ACTUATION

Solenoid Valves - Coupled Diaphragm Normally Closed Stainless Steel

Connections: 3/8 - 1 1/2 with 8 watt, 12 watt and 14 watt coils

Operation: 2 way normally closed

PROCESS VALVES AND ACTUATION

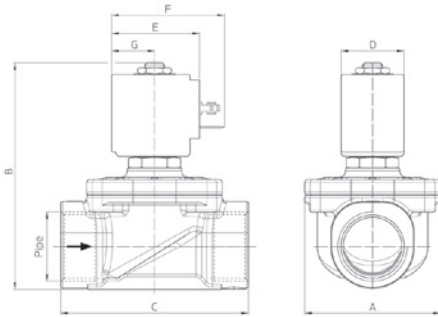

Technical Data

Type of Construction

Direct coupled, normally closed

Line Media

Air, oil, water, gas

Operating Pressure

See table

Operating Temperature

Ambient: -10°C to +80°C

Fluid: -10°C to +140°C

Threads

BSPG GAS Parallel ISO 228/1

Materials

Body: 316 Stainless Steel

Plunger: 306 Stainless steel

Seals: Viton

Mounting

Normally in fixed pipework

Standard Voltages

12v DC 24v DC

24v AC 110v AC 230v AC

Protection Rating

IP65 with connector

- see pages 134-137

Power Consumption

See table

Special Requests

For assistance, contact our technical office or your local Camozzi distributor.

- ✓ Ex Stock
- ✎ UK Assembly
- ⓞ Please Call Sales Office

		Orifice		Pressure Range (bar)				Kv	Coil Type
		Size	mm	Watt	Min	AC	DC		
21IH3K1V150	✓	3/8	15	8	0	14	6	2.4	B
21IH3K1V150	✓	3/8	15	12	0	-	14	2.4	U
21IH4K1V160	✓	1/2	16	8	0	14	6	3	B
21IH4K1V160	✓	1/2	16	12	0	-	14	3	U
21IH5K1V200	✓	3/4	20	8	0	14	6	3.6	B
21IH5K1V200	✓	3/4	20	12	0	-	14	3.6	U
21IH6K1V250	✓	1	25	8	0	14	3	8.4	B
21IH6K1V250	✓	1	25	12	0	-	8	8.4	U
21IH6K1V250	✓	1	25	14	0	-	14	8.4	G
21IH7K1V350	✓	1 1/4	35	14	0	14	7	18	G
21IH8K1V400	✓	1 1/2	40	14	0	14	7	21	G

Coil Type	Dimensions mm				
	W	D	E	F	G
B	8	30	42	54	20.5
U	12	36	48	60	23.5
G	14	52	55	67	25

Type		Dimensions mm		
		A	B	C
21IH3K1V510	✓	52	92	68
21IH4K1V160	✓	52	92	68
21IH5K1V200	✓	58	100	75
21IH6K1V250	✓	65	109	90
21IH7K1V350	✓	94	126	128
21IH8K1V400	✓	94	126	128



For Moulded Connectors

See pages 136 and 137

Series NA NAMUR Valves and Solenoid Valves

Connection: 1/4

Electropneumatically operated 3/2, 5/2, 5/3 way with interface according to NAMUR standard

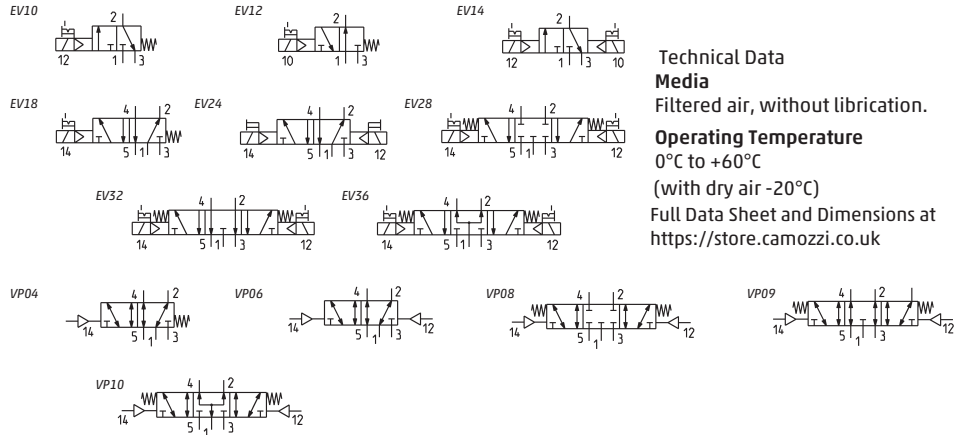

Technical Data
Media
 Filtered air, without lubrication.
Operating Temperature
 0°C to +60°C
 (with dry air -20°C)
 Full Data Sheet and Dimensions at
<https://store.camozzi.co.uk>

- ✓ Ex Stock
- ✎ UK Assembly
- ☎ Please Call Sales Office

Coils	Connector	Silencer	Straight Connection	Elbow Fitting
-------	-----------	----------	---------------------	---------------



Part Number	Availability	Function	Symbol	Flow Rate (Nl/min)	Operating Pressures (Bar)	Minimum Pilot Pressures (Bar)
NA34N-15-02-*	✓	3/2	EV10	1000	2-10	-
NA44N-15-02-*	✓	3/2 NO	EV12	1000	2-10	-
NA54N-15-02-*	✓	5/2	EV18	1000	2-10	-
NA34N-11-02-*	✓	3/2 NC	EV24	1000	1-10	-
NA54N-11-02-*	✓	5/2	EV24	1000	1-10	-
NA64N-11-02-*	✓	5/3 CC	EV28	1000	1.5-10	-
NA74N-11-02-*	✓	5/3 CO	EV32	1000	1.5-10	-
NA84N-11-02-*	✓	5/3 CP	EV36	1000	1.5-10	-
NA54N-33	✓	5/2	VP06	1000	-0.9-10	2.5
NA54N-35	✓	5/2	VP04	1000	-0.9-10	2.5
NA64N-33	✓	5/3 CC	VP08	1000	-0.9-10	2.5
NA74N-33	✓	5/3 CO	VP09	1000	-0.9-10	2.5
NA84N-33	✓	5/3 CP	VP10	1000	-0.9-10	2.5

Coils	Connector	Silencer	Straight Connection	Elbow Fitting
U7*	KB132000B9	2901 1/4-17	S6510 6-1/4	S6520 6-1/4
U7*	KB132000B9	2901 1/4-17	S6510 6-1/4	S6520 6-1/4
U7*	KB132000B9	2901 1/4-17	S6510 6-1/4	S6520 6-1/4
U7*x2	KB132000B9x2	2901 1/4-17	S6510 6-1/4	S6520 6-1/4
U7*x2	KB132000B9x2	2901 1/4-17	S6510 6-1/4	S6520 6-1/4
U7*x2	KB132000B9x2	2901 1/4-17	S6510 6-1/4	S6520 6-1/4
U7*x2	KB132000B9x2	2901 1/4-17	S6510 6-1/4	S6520 6-1/4
U7*x2	KB132000B9x2	2901 1/4-17	S6510 6-1/4	S6520 6-1/4
-	-	2901 1/4-17	S6510 6-1/4	S6520 6-1/4
-	-	2901 1/4-17	S6510 6-1/4	S6520 6-1/4
-	-	2901 1/4-17	S6510 6-1/4	S6520 6-1/4
-	-	2901 1/4-17	S6510 6-1/4	S6520 6-1/4
-	-	2901 1/4-17	S6510 6-1/4	S6520 6-1/4

*Coil sold separately, see page 133 for voltage options (U7 Solenoid Coils)

For more connector options, including LED versions please see page 134-137

CODING EXAMPLE

NA	5	4N	15	02	U	7	7
NA SERIES: NAMUR					U SOLENOID MATERIAL U = PET H = Self-extinguishing nylon Explosion-proof (30 x 30)* G = PA * on request		
5 N° N° WAY/POSITIONS 3 = 3/2 4 = 3/2 N.A. 5 = 5/2 6 = 5/3 C.C. 7 = 5/3 C.O. 8 = 5/3 pressure centres PC	15 ACTUATION 11 = double solenoid 15 = single solenoid spring return 33 = pneumatic / pneumatic 35 = pneumatic / spring		7 SOLENOID DIMENSIONS 7 = 22 x 22 8 = 30 x 30 9 = 22 x 22 with memory				
4N CONNECTIONS 4 = 1/4 supply NAMUR Standards	02 SOLENOID INTERFACE 02 = mech. sol. 22 x 22		7 SOLENOID VOLTAGE: See page 133				

CAMOZZI AUTOMATION
ACTUATED VALVE ASSEMBLIES

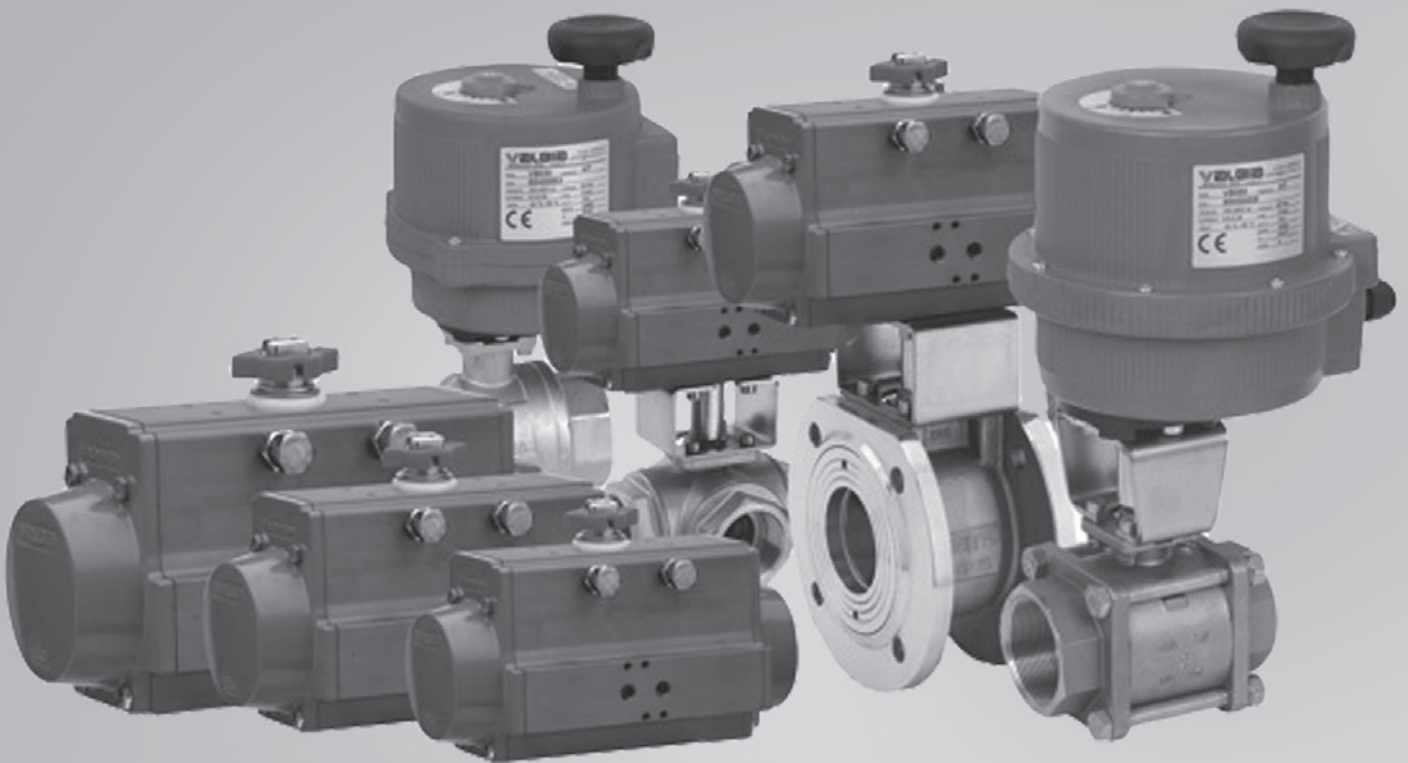





SAME DAY DESPATCH
TRY THE SERVICE TODAY!

Pneumatic and Electric Actuators
Single and Double Acting
Comprehensive Range of Valves
(Ex-Stock)
Fully Assembled and Tested

Hydraulic Couplings





1 Flat Face Couplings - ISO 16028

	Page
Hydraulic Flat Face Couplings - Technical Data - ISO 16028	317
 PLT1 Standard Range - Hydraulic Flat Face Couplings ISO 16028	318
 Dust Caps for Flat Face Couplings	318
 CAM FF (F/M) Range - Flat Face Couplings ISO 16028	319
 PLTX Stainless Steel Range - Hydraulic Flat Face Couplings ISO 16028	320
 PLT4 Premier Range - Hydraulic Flat Face Couplings ISO 16028	321

2 Quick Release Couplings - ISO A Norm

	Page
Hydraulic Quick Release Couplings - Technical Data ISO A Norm	322
 PAV1 Standard Range - Hydraulic Quick Release Couplings ISO A Norm	323
 Dust Caps and Plugs for ISO A	324
 CAM IA (F/M) Range - Hydraulic Quick Release Couplings ISO A Norm	324
 PAVX Standard Range - Hydraulic Quick Release Couplings ISO A Norm	325
 PPV Standard Range - Hydraulic Push-Pull Quick Release Couplings ISO A Norm	326

3 Quick Release Couplings - ISO B Norm

	Page
Hydraulic Quick Release Couplings - Technical Data ISO B Norm	327
 PBV1 Steel - Quick Release Couplings ISO B Norm	327
 Dust Caps for ISO B	328
 PBVM Brass - Hydraulic Quick Release Couplings ISO B Norm	328
 PBVX Stainless Steel - Hydraulic Quick Release Couplings ISO B Norm	329

4 Screw Couplings

	Page
 PVS1/PVS3 - Enerpac Interchange	330

5 Agricultural Coupling Trailer Brake

	Page
 PFT1/PFT3 - Agricultural Coupling Trailer Brake Standard Range	331

Hydraulic Flat Face Couplings - Technical Data - ISO 16028

PLT Range - ISO 16028

PLT1 Standard Range (250/350 Bar) Body size ISO 6.3 - 50

CAM FF (250-320 Bar) Body size ISO 6.3 - 19

PLT4 Premier Range (350/500 Bar) Body size ISO 5 - 25

PLT6 Ultra High Pressure Range (700 Bar)

Body size ISO 6.3 - 10

PLTX Standard Range in Stainless Steel (100/400 Bar)

Body size 6.3 - 50

The PLK4 range of probes has been designed to offer connection to PLT couplings under residual pressure. A full range of connections are available in BSP, Metric, NPT and UNF thread forms with tube connections from 6 to 30mm tube diameters to DIN 2353. Options include light and heavy thread forms in both short and long (Bulkhead) connections.

Applications

Flat faced couplings are particularly suitable for agriculture, construction and mobile equipment, mining and general industrial use.

Features

Heavy duty construction
High working pressures and flow rates low pressure drops
Designed for minimal spillage during connection and disconnection
Locking sleeve provided with safety system preventing accidental disconnection
Easy to keep clean.

General Technical Information

Body and Probe - All steel construction, stressed components nitrided or induction hardened
Finish - Zinc Plated in accordance with EEC directive 2000/53/CE (Chrome 6 free)
Seals - NBR standard EPDM, Viton and Neoprene on request. (PLTX Viton as standard)
Backing Ring - Teflon
Springs - C98 steel or stainless steel
Contact the sales office for special enquires and further technical information

PLT1 Standard Range - Hydraulic Flat Face Couplings

ISO 16028

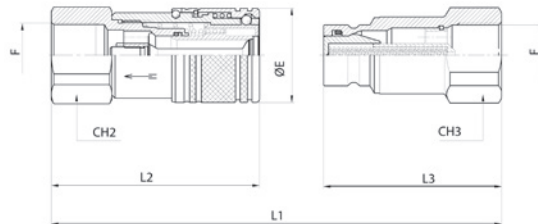

- ✓ Ex Stock
- ✎ UK Assembly
- ☎ Please Call Sales Office

Nominal Size		Max Working Pressure	Rated Flow	Max Flow Rate	Min. Burst Pressure			Fluid Spillage (CC)
ISO	mm				Male (bar)	Female (bar)	Coupled (bar)	
6.3	6	300	12	24	1800	1200	1400	0.008
10	8.6	250	23	46	1600	1000	1600	0.010
12.5	10.7	250	45	90	1500	1100	1900	0.012
19	14.8	250	100	200	1400	1100	1400	0.020
25	17.6	250	189	280	1300	1000	1400	0.030
31.5	26	200	260	520	800	1100	800	0.040
38	30	200	379	700	1200	1100	1100	0.050
51	40.6	150	757	1000	700	650	650	0.100

Technical Data

Characteristics

Easy connection and disconnection by pushing the two halves together with one hand only. The locking sleeve is provided with safety-system which makes sure a perfect connection and prevents accidental disconnection. Dimension 13 (DN13) conforms to HTMA specifications. All dimensions conform to ISO 16028 standard.

Threads

BSP
NPT on request

Materials

See page 317

Operating Temperature

NBR standard seals -25°C to +125°C

Special Requests

For assistance, contact our technical office or your local Camozzi distributor.

Other seals available on request.

F	ISO	CH2	CH3	ØE	L1	L2	L3	Standard	Carrier Half Part Number	Probe Half Part Number
1/4	6.3	22	22	28	100	58.5	52	DIN 3852-2-X	PLT1.0606.002	PLT1.0606.003
3/8	10	27	27	32	115.1	67.3	63.5	DIN 3852-2-X	PLT1.1310.002	PLT1.1310.003
1/2	10	27	27	32	124.1	72.3	67.5	DIN 3852-2-X	PLT1.1313.002	PLT1.1313.003
3/4	12.5	36	38	38	141.2	84	74.5	DIN 3852-2-X	PLT1.2019.002	PLT1.2019.003
3/4	19	46	41	48	157.5	93.6	86	DIN 3852-2-X	PLT1.2519.002	PLT1.2519.003
1	19	46	41	48	157.5	93.6	86	DIN 3852-2-X	PLT1.2525.002	PLT1.2525.003
1 1/4	25	50	50	55	177	109.3	90	DIN 3852-2-X	PLT1.3031.002	PLT1.3031.003
1 1/2	38	70	70	79	210	118.3	119.5	DIN 3852-2-X	PLT1.3939.002	PLT1.3939.003
2	51	90	90	103	283	147.4	173	DIN 3852-2-X	PLT1.5051.112	PLK4.5051.003

Dust Caps for Flat Face Couplings

- ✓ Ex Stock
- ✎ UK Assembly
- ☎ Please Call Sales Office

Dust Caps - for Flat Face Couplings

DIN	Thread	for Carrier		for Probe	
06	1/4	SPLT.06002	✓	SPLT.06003	✓
13	3/8	SPLT.13002	✓	SPLT.13003	✓
13	1/2	SPLT.13002	✓	SPLT.13003	✓
20	3/4	SPLT.20002	✓	SPLT.20003	✓
25	1	SPLT.25002	✓	SPLT.25003	✓
30	1 1/4	SPLT.30002	✓	SPLT.30003	✓

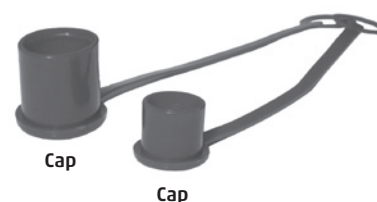

CAM FF (F/M) Range - Flat Face Couplings

ISO 16028

HYDRAULIC COUPLINGS

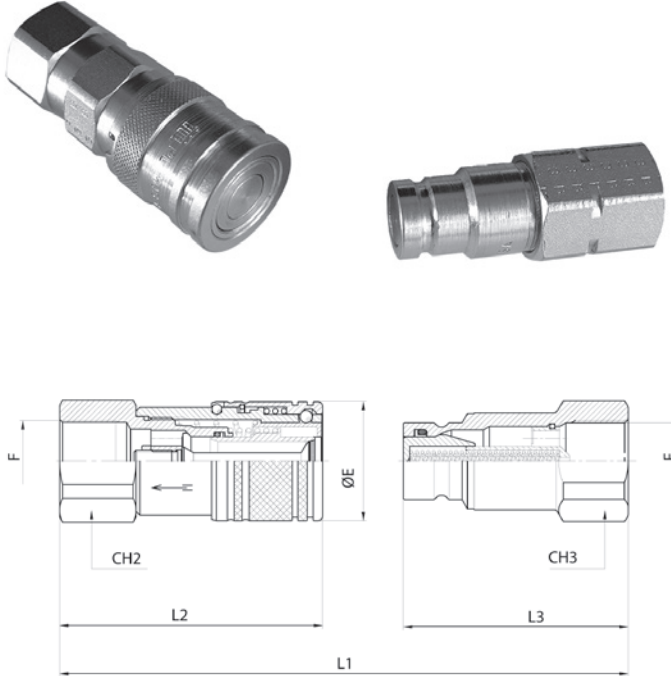

Technical Data

Characteristics

Flat mating surfaces easily wiped clean to prevent contamination and spillage during connection/disconnection. Connection is made by pushing the male coupling and disconnection by pulling back the sleeve of the female. Positive, quick connection of the male into the female by the latching ball system. Shut-off by flat valve.

Threads

BSP

Materials

See page 317

Operating Temperature

-30°C up to +110°C

Special Requests

For assistance, contact our technical office or your local Camozzi distributor.



See 318 for Dust Caps

- ✓ Ex Stock
- ✂ UK Assembly
- Ⓞ Please Call Sales Office

Nominal Size		Max Working Pressure (bar)	Rated Flow (l/min)	Min. Burst Pressure			Fluid Spillage (CC)
ISO	mm			Male (bar)	Female (bar)	Coupled (bar)	
6.3	04	350	15	1600	1400	1500	0.005
10	06	350	53	1400	1250	1450	0.007
12.5	08	350	98	1350	1150	1450	0.008
16	10	350	109	1500	1000	1400	0.008
19	12	350	174	1100	1020	1450	0.009

F	ISO	CH2	CH3	ØE	L1	L2	L3	Carrier Half Part Number	Probe Half Part Number
1/4"	6.3	24	22	28	104.6	63.6	52.1	CAM FFF 0404	CAM FFM 0404
3/8"	10	27	27	32	121.5	74.9	62.5	CAM FFF 0606	CAM FFM 0606
1/2"	10	27	27	32	127.5	77.9	65.5	CAM FFF 0608	CAM FFM 0608
3/4"	12.5	34	34	38	144.1	86.7	74.5	CAM FFF 0812	CAM FFM 0812
1"	20	41	41	48	178.7	108.9	91.5	CAM FFF 1216	CAM FFM 1216

PLTX Stainless Steel Range - Hydraulic Flat Face Couplings

ISO 16028

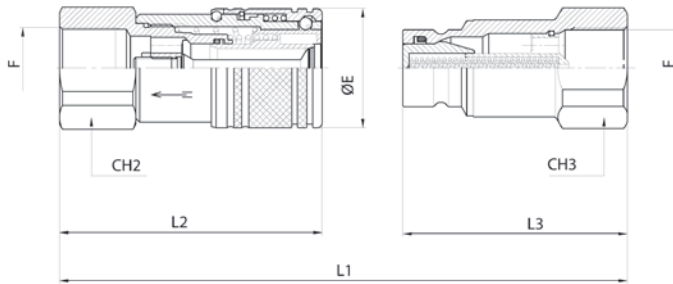
**Technical Data****Characteristics**

Easy connection and disconnection by pushing the two halves together with one hand only. The locking sleeve is provided with safety-system which makes sure a perfect connection and prevents accidental disconnection. Dimension 13 (DN13) conforms to HTMA specifications. All dimensions conform to ISO 16028 standard.

Threads

BSP

NPT on request

Materials

See page 317

Operating Temperature

with Viton seals -25°C to +200°C

Special Requests

For assistance, contact our technical office or your local Camozzi distributor.



See 318 for Dust Caps

HYDRAULIC COUPLINGS

- ✓ Ex Stock
- ✎ UK Assembly
- ☎ Please Call Sales Office

Nominal Size		Max Working Pressure (bar)	Rated Flow (l/min)	Max Flow Rate (l/min)	Min. Burst Pressure			Fluid Spillage (CC)
ISO	mm				Male (bar)	Female (bar)	Coupled (bar)	
6.3	6	300	12	24	2600	1600	1300	0.008
10	8.6	250	23	46	1400	1000	1900	0.010
12.5	10.7	250	45	90	1300	1000	1600	0.012
16	12.8	250	74	150	1100	1000	1400	0.015
19	14.8	250	100	200	1100	1000	1400	0.020
25	17.6	250	189	280	1000	1000	1000	0.030
38	30	150	379	700	600	600	600	0.050
51	40.6	100	757	1000	400	400	400	0.100

F	ISO	CH2	CH3	ØE	L1	L2	L3	Standard	Carrier Half Part Number	Probe Half Part Number
1/4	6.3	22	22	28	108	58.5	60	DIN 3852-2-x	PLTX.0606.112	PLTX.0606.113
3/8	10	27	27	32	127.3	73.5	69.5	DIN 3852-2-X	PLTX.1310.112	PLTX.1310.113
1/2	10	27	27	32	126.8	73.5	69	DIN 3852-2-X	PLTX.1313.112	PLTX.1313.113
1/2	12.5	36	36	38	147.7	83.5	81.5	DIN 3852-2-X	PLTX.2013.112	PLTX.2013.113
3/4	12.5	36	36	38	149.2	83.5	83	DIN 3852-2-X	PLTX.2019.112	PLTX.2019.113
1	19	41	41	40	166.5	97.5	90.5	DIN 3852-2-X	PLTX.2525.112	PLTX.2525.113
1 1/4	25	50	50	55	181.5	109.3	95	DIN 3852-2-X	PLTX.3031.112	PLTX.3031.113
1 1/2	38	70	70	79	213	118	122.5	DIN 3852-2-X	PLTX.3939.112	PLTX.3939.113
2	51	80	80	99	251.2	149	139.6	DIN 3852-2-X	PLTX.5051.112	PLTX.5051.113

PLT4 Premier Range - Hydraulic Flat Face Couplings

ISO 16028

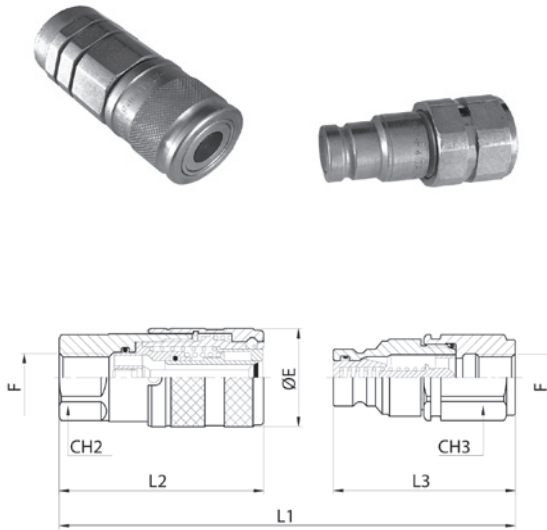

Technical Data

Characteristics

PLT4 couplings are manufactured to the ISO 16028 standard. This guarantees:

- interchangeability with other couplings manufactured to this standard.
 - maximum operating pressure 350 bar for all sizes
 - Safety factor 1:4 coupled and uncoupled
- reliable operation of the coupling with low pressure drops guaranteed, irrespective of the flow direction, male to female or female to male

Materials

See page 317

Threads

Metric - G(BSP)

NPT according to DIN 3852 form Y.
UNF thread according to SAE J1926 norm

Outside metric according to DIN 2353 L(light) or S(heavy).

Outside metric according to DIN 2353 L(light) or S(heavy) bulkhead

Operating Temperature

NBR standard seals -25°C to +100°C



See page 318 for Dust Caps

- ✓ Ex Stock
- ✎ UK Assembly
- ☎ Please Call Sales Office

Nominal Size		Max Working Pressure (bar)	Rated Flow (l/m)	Max Flow Rate (l/m)	Min. Burst Pressure			Fluid Spillage (CC)
ISO	mm				Male (bar)	Female (bar)	Coupled (bar)	
5	4	500	3	9	2500	2100	2500	0.006
6.3	6	400	12	24	1900	1900	1900	0.008
10	8.6	350	23	46	1500	1700	1600	0.010
12.5	10.7	350	45	90	1700	1500	1700	0.012
16	12.8	350	74	150	1600	1400	1500	0.015
19	14.8	350	100	200	1600	1400	1800	0.020
25	17.6	350	189	280	1400	1400	1500	0.030

F	ISO	CH2	CH3	ØE	L1	L2	L3	Standard	Carrier Half Part Number	Probe Half Part Number
BSP 1/8	5	17	17	25	84.1	48.6	43.5	DIN 3852-2-X	PLT4.0404.112	PLT4.0404.113
BSP 1/4	6.3	22	22	28	100	58.5	52	DIN 3852-2-X	PLT4.0606.112	PLT4.0606.113
BSP 3/8	6.3	22	22	28	100	58.5	52	DIN 3852-2-X	PLT4.0610.112	PLT4.0610.113
BSP 3/8	10	30	30	32	118.3	73.5	60.5	DIN 3852-2-X	PLT4.1310.112	PLT4.1310.113
BSP 1/2	10	30	30	32	118.3	73.5	60.5	DIN 3852-2-X	PLT4.1313.112	PLT4.1313.113
M22x1.5	10	30	30	32	122.3	74.5	63.5	SAE J 2244/1	PLT4.1322.102	PLT4.1322.103
BSP 1/2	12.5	36	36	38	138.7	83.5	72.5	DIN 3852-2-X	PLT4.2013.112	PLT4.2013.113
BSP 3/4	12.5	36	36	38	140.7	83.5	74.5	DIN 3852-2-X	PLT4.2019.112	PLT4.2019.113
3/4-16 UNF 2B	12.5	36	36	38	132.2	79.5	70	SAE J 1926-1	PLT4.2019.032	PLT4.2019.033
7/8-14 UNF 2B	12.5	36	36	38	138.2	81.5	74	SAE J 1926-1	PLT4.2023.032	PLT4.2023.033
BSP 1/2	16	38	38	42	141.2	86	72.5	DIN 3852-2-X	PLT4.2213.112	PLT4.2213.113
BSP 3/4	16	38	38	42	143.2	86	74.5	DIN 3852-2-X	PLT4.2219.112	PLT4.2219.113
3/4-16 UNF 2B	16	38	38	42	134.7	82	70	SAE J 1926-1	PLT4.2219.032	PLT4.2219.033
7/8-14 UNF 2B	16	38	38	42	140.7	84	74	SAE J 1926-1	PLT4.2223.032	PLT4.2223.033
1 1/16-12 UN 2B	16	38	38	42	142.7	86	74	SAE J 1926-1	PLT4.2227.032	PLT4.2227.033
BSP 3/4	19	41	41	48	159	94.5	86	DIN 3852-2-X	PLT4.2519.112	PLT4.2519.113
BSP 1	19	41	41	48	162	97.5	86	DIN 3852-2-X	PLT4.2525.112	PLT4.2525.113
BSP 1 1/4	25	55	55	55	176.5	109.3	50	DIN 3852-2-X	PLT4.3031.112	PLT4.3031.113

Hydraulic Quick Release Couplings - Technical Data - ISO A Norm

ISO 7241-1A

PAV1 Standard Range (160/350 Bar) Body sizes ISO 6.3 - 50
PA01 Valveless Range (200/350 Bar) Body sizes ISO 5 - 25

CAM IA (F/M) Range (250/350 Bar) Body sizes ISO 6.3 - 25
PPV Push - Pull Range (225/300 Bar) Body sizes ISO 6.3 - 25

The PKK range of probes has been designed to offer connection to PPV couplings under residual pressure.

A full range of connections are available in BSP, Metric and NPT thread forms with tube connections from 6 to 35mm tube diameters to DIN 2353. Options include light and heavy thread forms in both short and long (Bulkhead) connections.

Applications

ISO A couplings are the most common couplings in the market and used in all industrial applications. The PPV push - pull range are used extensively in agriculture.

Features

Simple and quick connection
Full interchange ability
Available with poppet valve or ball closing system
Compact and lightweight design
Valveless couplings available in zinc or chrome plated

General Technical Information

Body and Probe - All steel construction, stressed components nitrided or induction hardened
Finish - Zinc Plated in accordance with EEC directive 2000/53/CE (Chrome 6 free)
Seals - NBR standard EPDM, Viton and Neoprene on request. (SCBX Viton as standard)
Backing Ring - Telfon
Springs - C98 steel or stainless steel
Contact the sales office for special enquires and further technical information

More Than Just Pneumatics

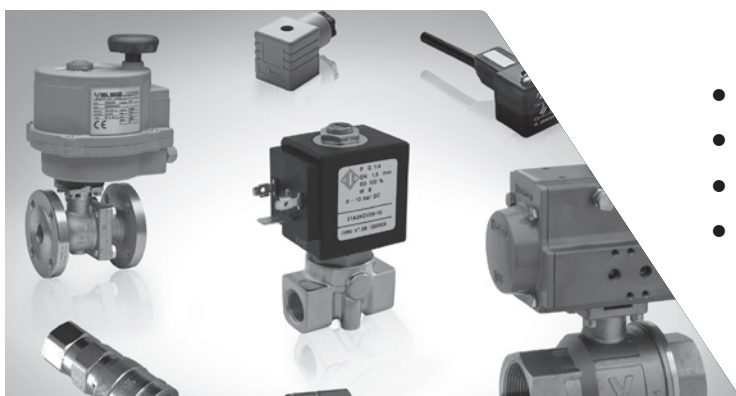

- Process Valves and Actuators
- Hydraulic Components
- Solenoid DIN Connectors
- Industrial Solenoid Valves

PAV1 Standard Range - Hydraulic Quick Release Couplings

ISO A Norm

HYDRAULIC COUPLINGS

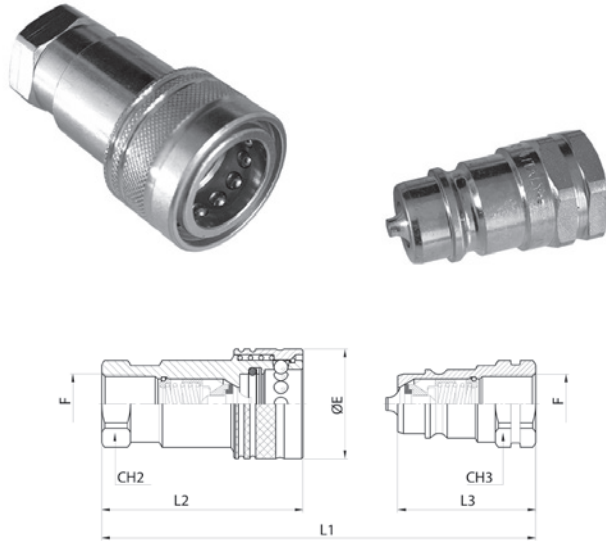

Technical Data

Material

See page 322

Threads

BSP and NPT

Operating Temperature

with NBR standard seals -25°C to +125°C

Special Requests

For assistance, contact our technical office or your local Camozzi distributor.

Other seal available on request.

- ✓ Ex Stock
- ✂ UK Assembly
- 📞 Please Call Sales Office

Nominal Size		Max Working Pressure (bar)	Rated Flow (l/min)	Max Flow Rate (l/min)	Min. Burst Pressure			Fluid Spillage (CC)
ISO	mm				Male (bar)	Female (bar)	Coupled (bar)	
6.3	5	350	12	17	1500	1700	1400	0.5
10	8.5	350	23	46	1400	1500	1500	1.9
12.5	10.5	250	45	90	1000	1400	1200	2.7
20	15.8	250	106	190	900	1500	1000	9.3
25	17.3	250	189	280	1300	1300	1200	16
31.5	22.8	200	288	480	1100	850	1000	30
40	29.9	190	379	757	800	800	820	54
50	37.7	160	757	1000	650	960	1000	120

F	ISO	CH2	CH3	ØE	L1	L2	L3	Standard	Carrier Half Part Number		Probe Half Part Number	
BSP 1/4	6.3	19	19	25	70.5	49.2	35	DIN 3852-2-X	PAV1.0606.002	✓	PAV1.0606.003	✓
NPT 1/4	6.3	19	19	25	70.5	49.2	35	ANSI B1.20.3	PAV1.0606.012	✓	PAV1.0606.013	✓
BSP 3/8	10	22	22	30	85	60.5	42.5	DIN 3852-2-X	PAV1.1010.002	✓	PAV1.1010.003	✓
NPT 3/8	10	22	22	30	85	60.5	42.5	ANSI B1.20.3	PAV1.1010.012	⊗	PAV1.1010.013	⊗
BSP 1/2	12.5	27	27	35	98.5	70	48	DIN 3852-2-X	PAV1.1313.002	✓	PAV1.1313.003	✓
NPT 1/2	12.5	27	27	35	98.5	70	48	ANSI B1.20.3	PAV1.1313.012	⊗	PAV1.1313.013	⊗
BSP 3/4	20	34	34	45	114.5	84.3	57	DIN 3852-2-X	PAV1.2019.002	✓	PAV1.2019.003	✓
NPT 3/4	20	34	34	45	114.5	84.3	57	ANSI B1.20.3	PAV1.2019.012	⊗	PAV1.2019.013	⊗
BSP 1	25	41	41	52	135.5	101	67.5	DIN 3852-2-X	PAV1.2525.002	✓	PAV1.2525.003	✓
NPT 1	25	41	41	52	135.5	101	67.5	ANSI B1.20.3	PAV1.2525.012	⊗	PAV1.2525.013	⊗
BSP 1 1/4	31.5	50	50	70	150.6	117	75	DIN 3852-2-X	PAV1.3031.002	✓	PAV1.3031.003	✓
NPT 1 1/4	31.5	50	50	70	150.6	117	75	ANSI B1.20.3	PAV1.3031.012	⊗	PAV1.3031.013	⊗
BSP 1 1/2	40	60	60	82	167.3	133	63.5	DIN 3852-2-X	PAV1.3939.002	✓	PAV1.3939.003	✓
NPT 1 1/2	40	60	60	82	167.3	133	63.5	ANSI B1.20.3	PAV1.3939.012	⊗	PAV1.3939.013	⊗
BSP 2	50	75	75	99	217	169	108	DIN 3852-2-X	PAV1.5051.002	✓	PAV1.5051.003	✓
NPT 2	50	75	75	99	217	169	108	ANSI B1.20.3	PAV1.5051.012	⊗	PAV1.5051.013	⊗

Dust Caps and Plugs for ISO A

- ✓ Ex Stock
- ✎ UK Assembly
- ☎ Please Call Sales Office

Dust Caps - for ISO 'A' Series					
DN	Carrier Half		Probe Half		
06	SPAV.06002	✓	SPAV.06003	✓	
10	SPAV.10002	✓	SPAV.10003	✓	
13	SPAV.13002	✓	SPAV.13003	✓	
20	SPAV.20002	✓	SPAV.20003	✓	
25	SPAV.25002	✓	SPAV.25003	✓	
30	SPAV.30202	✓	SPAV.30203	✓	
39	SPAV.39202	✓	SPAV.39203	✓	
50	SPAV.50202	✓	SPAV.50203	✓	



Cap

Plug

CAM IA (F/M) Range - Hydraulic Quick Release Couplings

ISO A Norm

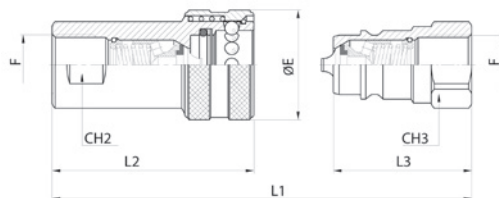

Technical Data

Threads

BSP

Materials

See page 322

Operating Temperature

-30°C up to +110°C

Special Requests

For assistance, contact our technical office or your local Camozzi distributor.



See above Dust Caps

- ✓ Ex Stock
- ✎ UK Assembly
- ☎ Please Call Sales Office

Nominal Size		Max Working Pressure (bar)	Rated Flow (l/min)	Min. Burst Pressure			Fluid Spillage (CC)
ISO	mm			Male (bar)	Female (bar)	Coupled (bar)	
6.3	04	350	5	2000	1500	1500	0.7
10	06	350	35	1400	1500	1500	1.4
12.5	08	300	75	1250	1500	1500	1.8
20	12	250	147	1000	1200	1000	7
25	16	250	250	1000	1000	1000	11

F	ISO	CH2	CH3	ØE	L1	L2	L3	Carrier Half Part Number		Probe Half Part Number	
1/4"	6.3	17	17	24	69.1	48.8	34.5	CAM IAF 0404	✓	CAM IAM 0404	✓
3/8"	10	22	22	30	80.3	57.8	40	CAM IAF 0606	✓	CAM IAM 0606	✓
1/2"	12.5	27	27	38	90.2	67	45	CAM IAF 0808	✓	CAM IAM 0808	✓
3/4"	20	34	34	45	113.3	83.5	56.5	CAM IAF 1212	✓	CAM IAM 1212	✓
1"	25	41	41	52	129.7	97.9	64.5	CAM IAF 1616	✓	CAM IAM 1616	✓

PAVX Standard Range - Hydraulic Quick Release Couplings

ISO A Norm

HYDRAULIC COUPLINGS

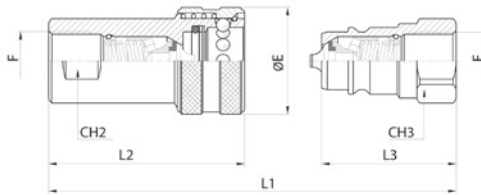

Technical Data

Material

Stainless Steel - AISI 316.
Springs - AISI 302
Seals - standard (Viton™)
Back-up Ring: In pure Teflon

Operating Temperature

With Viton standard seals -25 to +200°C

With NBR seals -25 to +125°C

Special Requests

For assistance, contact our technical office or your local Camozzi distributor.



See page 324 for Dust Caps

- ✓ Ex Stock
- ✂ UK Assembly
- ☎ Please Call Sales Office

Nominal Size		Max Working Pressure (bar)	Rated Flow (l/min)	Max Flow Rate (l/min)	Min. Burst Pressure			Fluid Spillage (CC)
ISO	mm				Male (bar)	Female (bar)	Coupled (bar)	
6.3	5	450	12	17	3200	2900	2900	0.5
10	8.5	300	23	46	12500	12500	1300	1.9
12.5	10.5	300	45	90	1200	1200	13500	2.7
20	15.8	250	106	190	800	1000	1100	9.3
25	17.3	200	189	280	600	650	850	19
31.5	22.8	100	288	480	400	400	400	30
40	29.9	80	379	700	320	320	320	54
50	37.7	60	757	1000	250	250	250	120

F	ISO	CH2	CH3	ØE	L1	L2	L3	Standard	Carrier Half Part Number	Probe Half Part Number
BSP 1/4	6.3	19	19	26	71.5	50.5	35.5	DIN 3852-2-X	PAVX.0606.002	PAVX.0606.003
BSP 3/8	10	22	22	30	82	58.5	40.5	DIN 3852-2-X	PAVX.1010.002	PAVX.1010.003
BSP 1/2	12.5	27	27	37.9	92	68	46	DIN 3852-2-X	PAVX.1313.002	PAVX.1313.003
M22x1.5	12.5	27	27	37.9	92	68	46	SAE J 2244/1	PAVX.1322.102	PAVX.1322.103
BSP 3/4	20	34	34	45	120.5	84.3	57	DIN 3852-2-X	PAVX.2019.002	PAVX.2019.003
BSP 1	25	41	41	52	127	97	63.5	DIN 3852-2-X	PAVX.2525.002	PAVX.2525.003
BSP 1 1/4	31.5	50	50	70	150	115	69	DIN 3852-2-X	PAVX.3031.002	PAVX.3031.003
BSP 1 1/2	40	60	60	80.5	146	123	73	DIN 3852-2-X	PAVX.3939.002	PAVX.3939.003
BSP 2	50	70	70	102	180	147	90	DIN 3852-2-X	PAVX.5051.002	PAVX.5051.003

PPV Standard Range - Hydraulic Push-Pull Quick Release Couplings

Application: Quick release couplings of the "Push-Pull" series are designed for use in all agricultural applications. The main characteristic of this coupling is to allow an automatic release in case of accidental pulls. This system avoids possible damage to the hydraulic circuit.

ISO A Norm



Technical Data

Material

See page 322

Operating Temperature

NBR standard seals -25°C to +125°C

Special Requests

For assistance, contact our technical office or your local Camozzi distributor.



See page 324 for Dust Caps

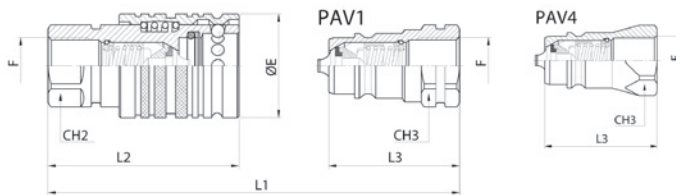

- ✓ Ex Stock
- 🔧 UK Assembly
- 📞 Please Call Sales Office

Nominal Size		Max Working Pressure (bar)	Rated Flow (l/min)	Max Flow Rate (l/min)	Min. Burst Pressure			Fluid Spillage (CC)
ISO	mm				Male (bar)	Female (bar)	Coupled (bar)	
12.5	10.5	250	45	90	1000	1600	1200	2.7

F	ISO	CH2	CH3	ØE	L1	L2	L3	Standard	Carrier Half Part Number		Probe Half Part Number	
BSP 1/2	12.5	27	27	38	96.3	70	48	DIN 3852-2-X	PPV1.1313.002	✓	PAV1.1313.003	✓
											PAV4.1313.003	✓
NPT 1/2	12.5	27	27	38	96.3	70	48	ANSI B1.20.3	PPV1.1313.012	📞	PAV1.1313.013	📞
M22x1.5	12.5	27	27	38	92.8	66.5	48	SAE J 2244/1	PPV1.1322.102	✓	PAV1.1322.103	✓
3/4-16 UNF 2B	12.5	27	27	38	96.3	70	48	SAE J 1926-1	PPV1.1319.032	✓	PAV4.1319.033	✓

Hydraulic Quick Release Couplings - Technical Data

ISO 7241-1B

PBV1 Carbon Steel Range (500/50 Bar) Body sizes ISO 04 - 50

ISO B Norm

PBVM Brass Range (300/50 Bar) Body sizes ISO 04 - 50

PBVX Stainless Steel Range (400/50 Bar) Body sizes ISO 04 - 50

These couplings are stocked in 1/8 - 2 BSP (NPT and UNF threads available on request).

Applications: The robust nature of these couplings make the suitable for the iron, steel, oil and automobile industry. They offer excellent flow characteristics.

PBV1 Steel - Quick Release Couplings

ISO B Norm

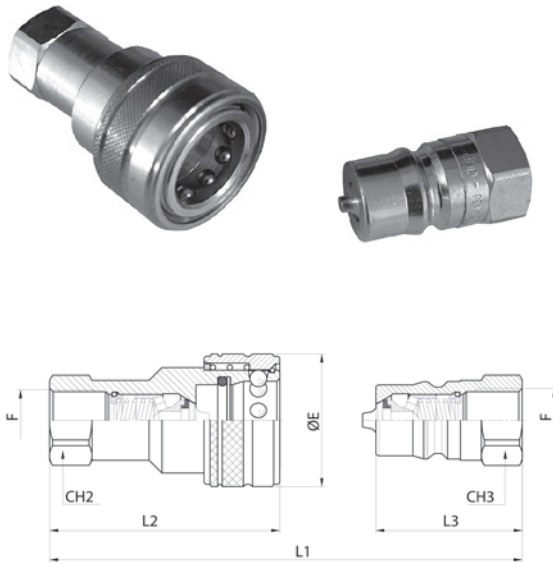

Technical Data

Threads

BSP

NPT available on request

Material

Main parts in carbon steel. Springs in AISI 302 and balls in AISI 316

Seals: Standards are in Nitrile. Other seals provided on request

Back-up Ring: In pure Teflon

Operating Temperature

NBR standard seals -25°C to +200°C

Special Requests

For assistance, contact our technical office or your local Camozzi distributor.

✓ Ex Stock

✎ UK Assembly

⊗ Please Call Sales Office

Nominal Size		Max Working Pressure (bar)	Rated Flow (l/min)	Max Flow Rate (l/min)	Min. Burst Pressure			Fluid Spillage (CC)
ISO	mm				Male (bar)	Female (bar)	Coupled (bar)	
5	4.2	500	3	9	2400	2300	2700	0.5
6.3	6.5	250	12	24	1100	1800	1000	1
10	8.5	250	23	46	1400	1400	1300	2.4
12.5	10.5	250	45	90	1100	1400	1100	3.9
20	15.8	250	106	220	1000	1300	1200	11
25	17.3	250	189	260	1000	1100	1000	19
40	36	200	379	757	800	800	800	95
50	50	100	757	1000	400	400	400	170

F	ISO	CH2	CH3	ØE	L1	L2	L3	Standard	Carrier Half Part Number	Probe Half Part Number
BSP 1/8	5	17	14	23	64.1	50.7	32	DIN 3852-2-X	PBV1.0404.002	✓ PBV1.0404.003 ✓
BSP 1/4	6.3	19	19	28	76.5	60	38	DIN 3852-2-X	PBV1.0606.002	✓ PBV1.0606.003 ✓
BSP 3/8	10	22	22	35	85.5	67.2	42.5	DIN 3852-2-X	PBV1.1010.002	✓ PBV1.1010.003 ✓
BSP 1/2	12.5	27	27	44	96.5	75.7	48	DIN 3852-2-X	PBV1.1313.002	✓ PBV1.1313.003 ✓
BSP 3/4	20	34	34	52	114.5	91.5	57	DIN 3852-2-X	PBV1.2019.002	✓ PBV1.2019.003 ✓
BSP 1	25	41	41	60	132	105.8	65.5	DIN 3852-2-X	PBV1.2525.002	✓ PBV1.2525.003 ✓
BSP 1 1/4	40	65	65	78.6	201.5	126.5	127	DIN 3852-2-X	PBV1.3931.002	✓ PBV1.3931.003 ✓
BSP 1 1/2	40	65	65	78.6	201.5	126.5	127	DIN 3852-2-X	PBV1.3939.002	⊗ PBV1.3939.003 ⊗
BSP 2	50	90	90	105	221	142	142	DIN 3852-2-X	PBV1.5051.002	⊗ PBV1.5051.003 ⊗

Dust Caps for ISO B

Application: Quick release couplings of the "Push-Pull" series are designed for use in all agricultural applications. The main characteristic of this coupling is to allow an automatic release in case of accidental pulls. This system avoids possible damage to the hydraulic circuit.

Body Size	Colour	Material	Female Dust Plug		Male Dust Cap	
1/8	Red	PVC*	SPBV.04002	✓	SPBV.04003	✓
1/4	Red	PVC*	SPBV.06002	✓	SPBV.06003	✓
3/8	Red	PVC*	SPBV.10002	✓	SPBV.10003	✓
1/2	Red	PVC*	SPBV.13002	✓	SPBV.13003	✓
3/4	Red	PVC*	SPBV.20002	✓	SPBV.20003	✓
1	Red	PVC*	SPBV.25002	✓	SPBV.25003	✓
1 1/2	-	Aluminium	SPBV.39002	✓	SPBV.39003	✓
2	-	Aluminium	SPBV.50002	✓	SPBV.50003	✓

* Also available in Aluminium

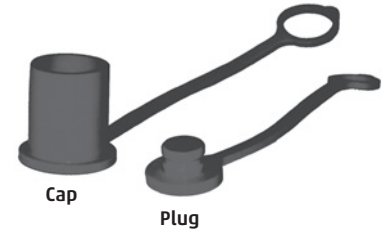

PBVM Brass - Hydraulic Quick Release Couplings

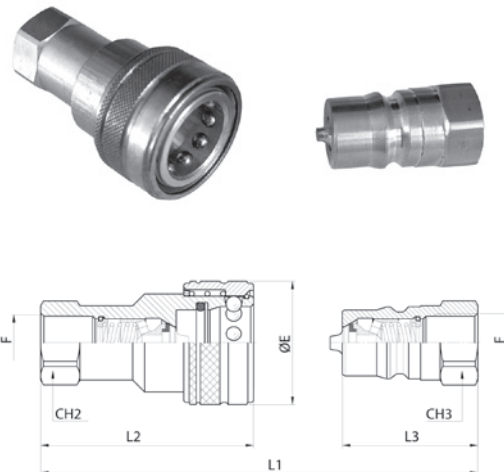

ISO B Norm

- ✓ Ex Stock
- 🔧 UK Assembly
- 📞 Please Call Sales Office

Nominal Size	ISO	mm	Max Working Pressure (bar)	Rated Flow (l/min)	Max Flow Rate (l/min)	Min. Burst Pressure			Fluid Spillage (CC)
						Male (bar)	Female (bar)	Coupled (bar)	
5	4.2	300	3	9	1200	1900	1500	0.5	
6.3	6.5	200	12	24	800	800	1200	1	
10	8.5	200	23	46	800	850	950	2.4	
12.5	10.5	180	45	90	720	900	1000	3.9	
20	15.8	130	106	220	550	650	800	11	
25	17.3	130	189	260	550	700	600	19	
40	36	60	379	757	250	250	250	95	
50	50	50	757	1000	200	200	200	170	

Technical Data

Threads

BSP
NPT available on request

Material

Main parts in brass. Springs in AISI 302 and balls in AISI 316
Seals: Standards are in FPM (Viton™).
Other seals provided on request
Back-up Ring: In pure Teflon

Operating Temperature

NBR standard seals -25°C to +200°C

Special Requests

For assistance, contact our technical office or your local Camozzi distributor.



See above for Dust Caps

F	ISO	CH2	CH3	ØE	L1	L2	L3	Standard	Carrier Half Part Number		Probe Half Part Number	
BSP 1/8	5	17	14	23	64.1	50.6	32	DIN 3852-2-X	PBVM.0404.002	✓	PBVM.0404.003	✓
BSP 1/4	6.3	19	19	28	76.5	60	38	DIN 3852-2-X	PBVM.0606.002	✓	PBVM.0606.003	✓
BSP 3/8	10	22	22	35	81.5	67.2	42.5	DIN 3852-2-X	PBVM.1010.002	✓	PBVM.1010.003	✓
BSP 1/2	12.5	27	27	44	96.5	75.7	48	DIN 3852-2-X	PBVM.1313.002	✓	PBVM.1313.003	✓
BSP 3/4	20	34	34	52	114.5	91.5	57	DIN 3852-2-X	PBVM.2019.002	✓	PBVM.2019.003	✓
BSP 1	25	41	41	60	132	105.8	65.5	DIN 3852-2-X	PBVM.2525.002	✓	PBVM.2525.003	✓
BSP 1 1/4	40	65	65	78.5	201.5	126.5	127	DIN 3852-2-X	PBVM.3931.002	⊗	PBVM.3931.003	⊗
BSP 1 1/2	40	65	65	78.5	201.5	126.5	127	DIN 3852-2-X	PBVM.3939.002	⊗	PBVM.3939.003	⊗
BSP 2	50	90	90	105	221	142	142.5	DIN 3852-2-X	PBVM.5051.002	⊗	PBVM.5051.003	⊗

PBVX Stainless Steel - Hydraulic Quick Release Couplings

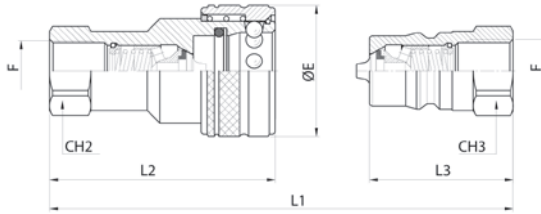

ISO B Norm

Technical Data

Threads

BSP

NPT available on request

Material

All components in stainless steel AISI 316. Springs in AISI 302.

Seals: Standard in FPM (Viton™).

Other seals provided on request

Back-up Ring: Teflon

Operating Temperature

Viton standard seals -25°C to +200°C

Special Requests

For assistance, contact our technical office or your local Camozzi distributor.



See page 328 for Dust Caps

- ✓ Ex Stock
- 🔧 UK Assembly
- 📞 Please Call Sales Office

Nominal Size		Max Working Pressure (bar)	Rated Flow (l/min)	Max Flow Rate (l/min)	Min. Burst Pressure			Fluid Spillage (CC)
ISO	mm				Male (bar)	Female (bar)	Coupled (bar)	
5	4.2	400	3	9	2100	2000	1400	0.5
6.3	6.5	350	12	24	1700	1500	1600	1
10	8.5	300	23	46	1100	1100	2100	2.4
12.5	10.5	300	45	90	1500	1400	1500	3.9
20	15.8	220	106	220	1000	900	1000	11
25	17.3	200	189	260	600	650	850	19
40	36	80	379	757	250	250	250	95
50	50	60	757	1000	200	200	200	170

F	ISO	CH2	CH3	ØE	L1	L2	L3	Standard	Carrier Half Part Number	Probe Half Part Number
BSP 1/8	5	14	14	23	64.1	50.6	32	DIN 3852-2-X	PBVX.0404.002	PBVX.0404.003
BSP 1/4	6.3	19	19	28	76.5	60	38	DIN 3852-2-X	PBVX.0606.002	PBVX.0606.003
BSP 3/8	10	22	22	35	81.5	65.2	40.5	DIN 3852-2-X	PBVX.1010.002	PBVX.1010.003
BSP 1/2	12.5	27	27	44	92.5	73.7	46	DIN 3852-2-X	PBVX.1313.002	PBVX.1313.003
BSP 3/4	20	34	34	51.8	114.5	91.5	57	DIN 3852-2-X	PBVX.2019.002	PBVX.2019.003
BSP 1	25	41	41	60	128	103.8	63.5	DIN 3852-2-X	PBVX.2525.002	PBVX.2525.003
BSP 1 1/4	40	65	65	78.5	201.5	126.5	127	DIN 3852-2-X	PBVX.3931.002	PBVX.3931.003
BSP 1 1/2	40	65	65	78.5	201.5	126.5	127	DIN 3852-2-X	PBVX.3939.002	PBVX.3939.003
BSP 2	50	90	90	105	220	142	142	DIN 3852-2-X	PBVX.5051.002	PBVX.5051.003

PVS1/PVS3 - Enerpac Interchange

Application: These couplings are available in DN10 (generally with 3/8NPT) and in DN06 (threaded 1/4NPT) with shut-off ball (PVS) or shut-off valve (PVM). The screw system allows connection and disconnection under pressure. Available with steel and aluminium dust caps and plugs for male/female.

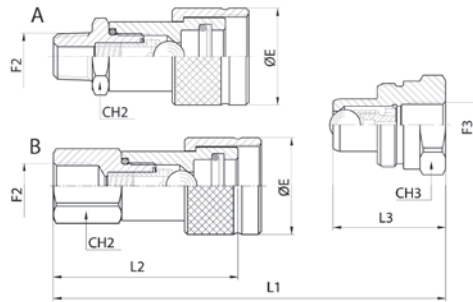

- ✓ Ex Stock
- ✂ UK Assembly
- ☎ Please Call Sales Office

Nominal Size		Max Working Pressure (bar)	Rated Flow (l/min)	Max Flow Rate (l/min)	Min. Burst Pressure			Fluid Spillage (CC)
ISO	mm				Male (bar)	Female (bar)	Coupled (bar)	
6.3	3.7	720	12	5	1500	2000	2200	0.2
10	4.8	720	23	9	1500	2000	2200	0.6

Technical Data

Characteristics

PVS and PVM couplings are specially designed for high pressure applications such as cylinders and hydraulic tools. They are interchangeable with the most common equivalents on the market.

Material

Special steel for high pressures zinc plated and white bichromated. Shut-off balls UNI 100CR6 precision's degree 'A'

Seals: Standard in nitrile NBR. FPM (Viton™) or EPDM on request

Back-up Ring: In pure Teflon

Operating Temperature

with NBR standard seals -25°C to +120°C

Special Requests

For assistance, contact our technical office.

F	ISO	CH2	CH3	ØE	L1	L2	L3	L4	Standard	Carrier Half Part Number	Probe Half Part Number
NPT 1/4	6.3	22	19	30	83.9	56	39		ANSI B1.20.3	PVS3.0606.012	PVS1.0606.013
NPT 1/4	6.3	22	19	30	99.9	53	58	14	ANSI B1.20.3	PVS3.0606.022	PVS1.0606.023
BSP 1/4	6.3	22		30		51.5		10.5	JIS B8363	PVS3.0606.212	
NPT 1/4	10		32	35			40.5		ANSI B1.20.3		PVS1.1006.013
BSP 3/8	10	24	32	35		66.5			DIN 3852-2-X	PVS3.1010.112	PVS1.1010.003
NPT 3/8	10	24	32	35	90.9	66	40.5		ANSI B1.20.3	PVS3.1010.012	PVS1.1010.013
NPT 1/4	10	24		35		64.5			ANSI B1.20.3	PVS3.1006.022	
NPT 3/8	10	24	32	35	106.9	62	60.5		ANSI B1.20.3	PVS3.1010.022	PVS3.1010.023
BSP 3/8	10	24		35		62.5			DIN 3852-2-A	PVS3.1010.212	

PFT1/PFT3 - Agricultural Coupling Trailer Brake Standard Range

Application: Agriculture is the specific area for the use of this series.
PFT couplings are specifically used to connect the hydraulic brake system.

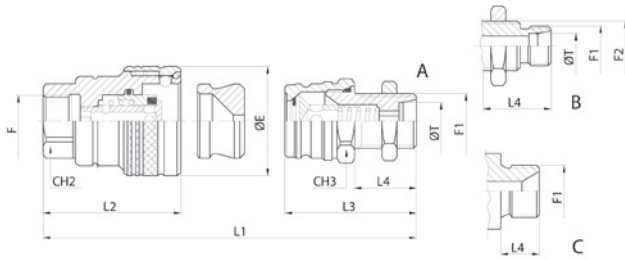

Technical Data

Characteristics

PFT couplings are produced according to NFU 16-006/68 corresponding to ISO 5676.

Easy connection and disconnection is possible by retracting the sleeve. Females of both series are supplied with steel plugs for housing when resting.

Material

Zinc plated steel with all high stressed components carbonitrided or hardened by induction
Seals: Standard in nitrile NBR. Other seals on request

Operating Temperature

with NBR standard seals -25°C to +125°C

Special Requests

For assistance, contact our technical office.



- ✓ Ex Stock
- ✎ UK Assembly
- ☎ Please Call Sales Office

Nominal Size		Max Working Pressure (bar)	Rated Flow (l/min)	Max Flow Rate (l/min)	Min. Burst Pressure			Fluid Spillage (CC)
ISO	mm				Male (bar)	Female (bar)	Coupled (bar)	
12.5	8	150	24	48	900	620	930	0.05



F	ISO	CH2	CH3	CH4	ØE	L1	L2	L3	L4	ØT	Standard	Carrier Half Part Number	Probe Half Part Number
BSP 3/8	12.5	27			44		55.5				DIN 3852-2-X	PFT1.1310.002	✓
BSP 1/2	12.5	27	28	32	44	98	55.5	57			DIN 3852-2-X	PFT1.1313.002	✓ PFT3.1313.113 ✓
M18x1.5	12.5	27			44		55.5				ISO 6149-1	PFT1.1318.102	✓
BSP 1/2	12.5			32	44			48	15.5		DIN 3852-2-A		PFT3.1313.213 ✓
M18x1.5	12.5			32	44			49	21	12L	ISO 8434-1-L		PFT3.1318.503 ✓
M18x1.5	12.5			32	44			58	30	12L	ISO 8434-1-L		PFT3.1318.523 ✓
M20x1.5	12.5			32	44			51	23	Ø13.4	-		PFT3.1320.503 ✓
M22x1.5	12.5			32	44			41	23	15L	ISO 8434-1-L		PFT3.1322.503 ✓
M22x1.5	12.5		32	32	44			82	28	15L	ISO 8434-1-L		PFT3.1322.623 ✓
M22x1.5	12.5			32	44			63	35	15L	ISO 8434-1-L		PFT3.1322.603 ✓
3/4-16 UNF 2A	12.5		28	32	44			50	11		SAE J 1926-2		PFT3.1319.223 ✓
M18x1.5	12.5		32	32	44			65	12	12L	ISO 8434-1-L		PFT3.1318.303 ✓
M22x1.5	12.5		32	32	44			65	12	15L	ISO 8434-1-L		PFT3.1322.303 ✓
M22x1.5	12.5			32	44			65	37		DIN 3863-U		PFT3.1322.613 ✓
3/4-16 UNF 2A	12.5		28	32	44			89.5	16.7		SAE J 514		PFT3.1319.503 ✓
7/8-14 UNF 2A	12.5		32	32	44			94	40		SAE J 514		PFT3.1378.603 ✓

Hydraulic Valves & Accessories



1 Hydraulic Ball Valves

	Page
 High Pressure 2-Way Ball Valves	333
 High Pressure 3-Way Diverter Ball Valves	334
 High Pressure Ball Valves (with fixing holes)	335

2 Actuated Ball Valves

	Page
 Pneumatically Actuated Two-Way Ball Valve - High Pressure	336
 Pneumatically Actuated Three-Way Ball Valve - High Pressure	337

3 Accessories

	Page
 In-Line Check Valves	338
 Flow Control & Needle Valves	339

High Pressure 2-Way Ball Valves

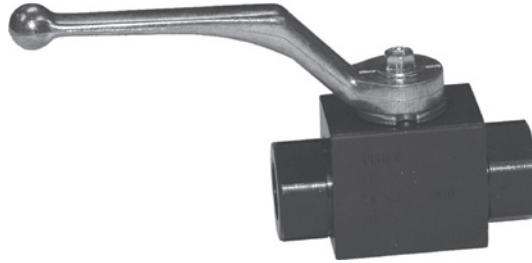

- ✓ Ex Stock
- ✎ UK Assembly
- ☎ Please Call Sales Office

Part Number: BKH.* - BKH Series, Barstock Steel

BSP (G), NPT (N), METRIC THREADS (L&S)						
DN	Bore	Thread	BAR	BSP Code		NPT Code
4	5	1/8	500	*1113 G18	✓	*1113 N18 ✓
6	6	1/4	500	*1113 G14	✓	*1113 N14 ✓
10	10	3/8	500	*1113 G38	✓	*1113 N38 ✓
13	13	1/2	500	*1113 G1213	✓	*1113 N12 ✓
16	15	1/2	500	*1113 G1215	✓	-
20	20	3/4	400	*1113 G34	✓	*1113 N34 ✓
25	24	1	350	*1113 G1	✓	*1113 N1 ✓
32	24	1 1/4	350	*1113 G54	✓	*1113 N54 ✓
40	24	1 1/2	350	*1113 G32	✓	*1113 N32 ✓

Outside metric according to DIN 2353 L (light) or S (heavy)

		Code Tube Size Light			Code Tube Size Heavy		
4	5	-	M12 x 1.5	500	*1113 6L	☉	-
6	6	-	M14 x 1.5	500	*1113 8L	☉	-
8	8	5	M16 x 1.5	500	*1113 10L	☉	*1113 8S ☉
10	10	6	M18 x 1.5	500	*1113 12L	☉	*1113 10S ☉
10	-	8	M20 x 1.5	500	-		*1113 12S ☉
13	13	10	M22 x 1.5	500	*1113 15L	☉	*1113 14S ☉
13	-	13	M24 x 1.5	500	-		*1113 16S ☉
16	15	-	M26 x 1.5	500	*1113 18L	☉	*1113 20S ☉
20	20	15	M30 x 2	400	*1113 22L	☉	*1113 20S ☉
25	24	20	M36 x 2	350	*1113 28L	☉	*1113 25S ☉
25	-	24	M42 x 2	350	-		*1113 30S ☉
32	24	-	M45 x 2	350	*1113 35L	☉	-
40	24	24	M52 x 2	350	*1113 42L	☉	*1113 38S ☉

Technical Data

Materials

Carbon steel, black phosphated, Polyamide/BUNA seals

Operating Pressure

See table

Safety Factor

1.5

Operating Temperature

-30°C - to +90°C

Additional Options

Forged steel bodies, DELRIN/BUNA, VITON, EPDM and PTFE seals

Special Requests

For assistance, contact our technical office or your local Camozzi distributor.

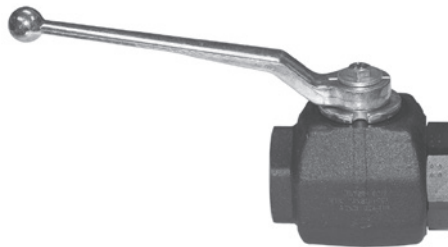

- ✓ Ex Stock
- ✎ UK Assembly
- ☎ Please Call Sales Office

Part Number: SKH.* - SKH Series, Forged Steel

BSP (G), NPT (N), METRIC THREADS (L&S)						
DN	Bore	Thread	BAR	BSP Code		NPT Code
32	32	1 1/4	420	*3123 G54	✓	*2123 N54 ✓
40	38	1 1/2	420	*3123 G32	✓	*3123 N32 ✓
50	48	2	420	*3123 G2-2PC	✓	*3123 N2 ✓
50	48	2	420	*1113 G2-3PC	✓	-
		Code Tube Size Light			Code Tube Size Heavy	
32	32	M45 x 2	420	*2123 35L	☉	*2123 38S ☉
40	38	M52 x 2	420	*2123 42L	☉	-

High Pressure 3-Way Diverter Ball Valves

- ✓ Ex Stock
- ✎ UK Assembly
- ⌚ Please Call Sales Office

Part Number: BK3* - BK3 Series, Barstock Steel

DN	Bore	Thread	BAR	Code BSP		Code NPT	
4	4	1/8	400	*1123 G18	⌚	-	
6	6	1/4	400	*1123 G14	⌚	*1123 N14	⌚
10	9	3/8	400	*1123 G38	⌚	*1123 N38	⌚
13	12	1/2	350	*1123 G12	⌚	*1123 N12	⌚



Technical Data

Materials

Carbon steel, black phosphated, DELRIN/BUNA seals

Operating Pressure

See table

Operating Temperature

-30°C - to +90°C

Special Requests

For assistance, contact our technical office or your local Camozzi distributor.

- ✓ Ex Stock
- ✎ UK Assembly
- ⌚ Please Call Sales Office

Part Number: SK3* - SK3 Series, Forged Steel

DN	Bore	Thread	BAR	Code BSP		Code NPT	
20	18	3/4	350	*2123 G34	✓	*2123 N34	✓
25	22	1	350	*2123 G1	✓	*2123 N1	✓
32	22	1 1/4	350	*2123 G5425	✓	*2123 N5425	✓
32	30	1 1/4	350	*2123 G5425	✓	*2123 N5432	✓
40	25	1 1/2	350	*2123 G3225	✓	*2123 N3225	✓
40	35	1 1/2	350	*2123 G3240	✓	*2123 N3240	✓
50	44	2	350	*2123 G2	✓	*2123 N2	✓



Customised Solutions

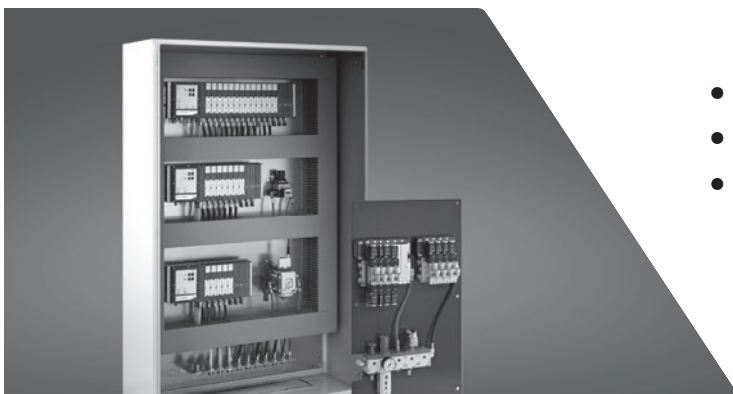

- Pre-Assembled Kits
- Special Products
- Control Cabinets and Systems

High Pressure Ball Valves (with fixing holes)

Connections: 1/4 - 1 1/2 BSP Female

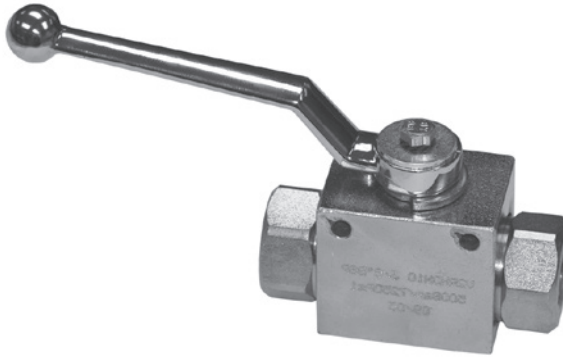

Technical Data

Materials

Carbon steel, zinc passivated, BUNA

Operating Pressure

See table

Operating Temperature

-20°C - to +100°C

Special Requests

For assistance, contact our technical office or your local Camozzi distributor.

- ✓ Ex Stock
- ✎ UK Assembly
- ☎ Please Call Sales Office

Part Number: VF2* - VF2 Series 2-Way

DN	Thread	BAR	Carbon Steel	
6	1/4	500	*1113 G14	✓
10	3/8	500	*1113 G38	✓
13	1/2	500	*1113 G12	✓
20	3/4	320	*1113 G34	✓
25	1	320	*1113 G1	✓
25	1 1/4	320	*1113 G54	✓
25	1 1/2	320	*1113 G32	✓

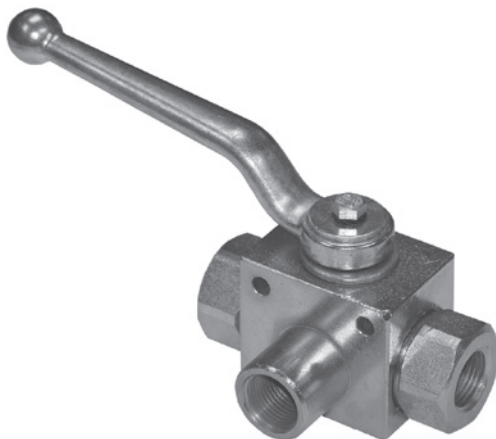

- ✓ Ex Stock
- ✎ UK Assembly
- ☎ Please Call Sales Office

Part Number: VF3* - VF3 Series 3-Way L or T

DN	Thread	BAR	Carbon Steel	
6	1/4	500	*1113 G14	✓
10	3/8	500	*1113 G38	✓
13	1/2	500	*1113 G12	✓
20	3/4	250	*1113 G34	✓
25	1	250	*1113 G1	✓
25	1 1/4	250	*1113 G54	✓
25	1 1/2	250	*1113 G32	✓

Pneumatically Actuated Two-Way Ball Valve - High Pressure

2 way Ball Valve in Stainless Steel and Carbon Steel, F/F threaded, for high pressure hydraulic applications, with pneumatic actuator

Part Number: Stainless Steel

8P022900* (double acting)

8P023000* (single acting)

Part Number: Carbon Steel

8P013700* (double acting)

8P013800* (single acting)

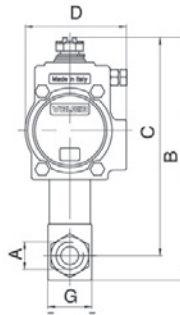
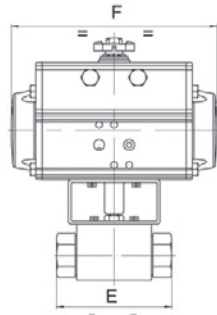
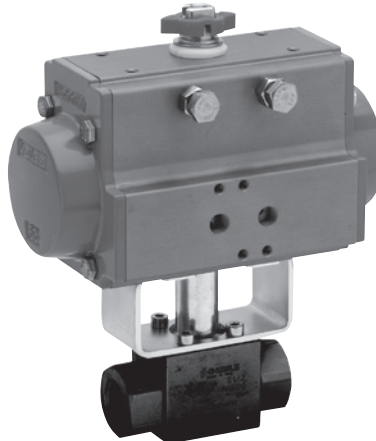
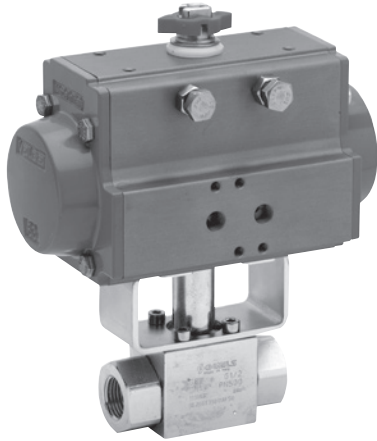

- ✓ Ex Stock
- 🔧 UK Assembly
- ☎ Please Call Sales Office

Valve with Double Acting Actuator. Types 8P022900 and Types 8P013700

Dimensions (mm)										
		Size/DN/A	PN	B	C	D	E	F	G	ACT
*03	🔧	3/8	500	182	164	71	73	141	35	DA 52
*04	🔧	1/2	500	196	178	81	83	164	37	DA 63
*05	🔧	3/4	400	226	203	95	95	210	45	DA 75
*06	🔧	1	350	237	207	95	112	210	55	DA 75
*07	🔧	1 1/4	350	292	245	123	115	275	88	DA 100
*08	🔧	1 1/2	350	306	252	123	131	275	102	DA 100
*10	🔧	2	350	347	290	137	140	333	118	DA 115

Valve with Spring Return Actuator. Types 8P023000 and Types 8P013800

Dimensions (mm)										
		Size/DN/A	PN	B	C	D	E	F	G	ACT
*03	🔧	3/8	500	212	194	95	73	210	35	SR 75
*04	🔧	1/2	500	214	196	95	83	210	37	SR 75
*05	🔧	3/4	400	254	230	123	95	275	45	SR 100
*06	🔧	1	350	264	234	123	112	275	55	SR 100
*07	🔧	1 1/4	350	326	279	137	115	333	88	SR 115
*08	🔧	1 1/2	350	340	286	137	131	333	102	SR 115
*10	🔧	2	350	421	364	164	140	435	118	SR 140

Technical Data

Operating Conditions

Fluid at +20°C, actuator air supply 6 - 7 BAR

Media

Suitable for hydraulic applications for other media please contact our technical office or your local Camozzi distributor

Operating Pressure

Nominal working pressure (PN) in BAR - See chart

Operating Temperature

-20°C to +80°C

Flow Rates

Please refer to Camozzi sales office

Threads

BSP F/F (others on request)

Materials

Body/Ball:
 8P022900*: Stainless Steel
 8P023000*: Stainless Steel
 8P013700*: Carbon Steel
 8P013800*: Carbon Steel
 Seats: Polyamide
 'O' Ring: NBR

Additional Options

Please contact Camozzi for more details



NAMUR solenoid valves



Limit switch box

Special Requests

For assistance, contact our technical office or your local Camozzi distributor.

HYDRAULIC VALVES & ACCESSORIES

Pneumatically Actuated Three-Way Ball Valve - High Pressure

3 way Ball Valve in CF9SMn28, "L" or "T" port, only diverting, F/F/F, threaded, for high pressure hydraulic applications, with pneumatic actuator.

Part Number: 8P015300* L - 8P015400* T (double acting)
8P015500* L - 8P015600* T (single acting)

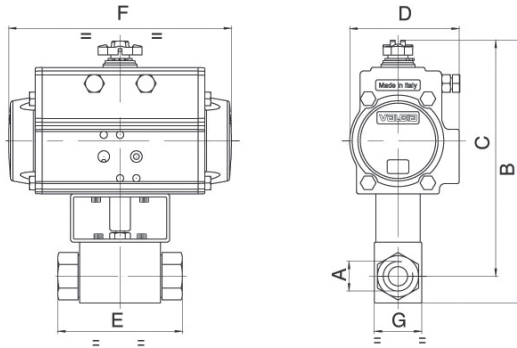
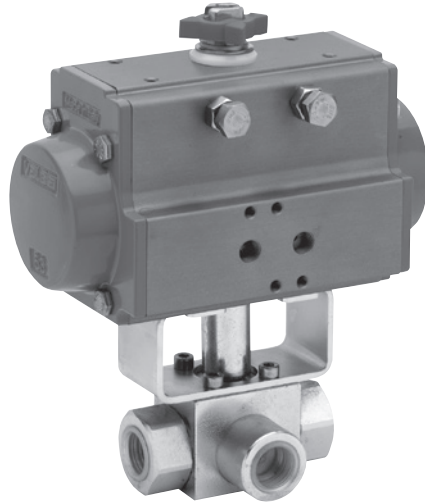

- ✓ Ex Stock
- 🔧 UK Assembly
- ☎ Please Call Sales Office

Valve with Double Acting Actuator. Types 8P015300 (L), 8P015400 (T)

Dimensions (mm)											
	Size/DN/A	PN	B	C	D	E	F	G	H	ACT	
*03	3/8	400	182	164	71	73	141	35	37	DA 52	
*04	1/2	350	196	178	81	83	164	37	40	DA 63	
*05	3/4	350	226	203	95	95	210	45	52	DA 75	
*06	1	350	236	207	95	112	210	55	60	DA 75	

Valve with Single Acting Actuator. Types 8P015500 (L), 8P015600 (T)

Dimensions (mm)											
	Size/DN/A	PN	B	C	D	E	F	G	H	ACT	
*03	3/8	400	211	194	95	73	210	35	37	SR 75	
*04	1/2	350	214	196	95	83	210	37	40	SR 75	
*05	3/4	350	253	230	123	95	275	45	52	SR 100	
*06	1	350	263	234	123	112	275	55	60	SR 100	

Technical Data

Operating Conditions

Fluid at +20°C

Media

Suitable for hydraulic applications for other media please contact our technical office or your local Camozzi distributor

Operating Pressure

Nominal working pressure (PN) in BAR - See chart

Operating Temperature

-20°C to +80°C

Flow Rates

Please refer to Camozzi sales office

Threads

BSP F/F/F (others on request)

Materials

Body/Ball: Steel

Seats: Polyamide

'O' Ring: NBR

Additional Options

Please contact Camozzi for more details

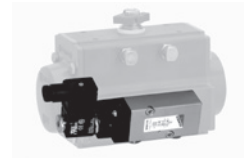

NAMUR solenoid valves



Limit switch box

Special Requests

For assistance, contact our technical office or your local Camozzi distributor.

In-Line Check Valves

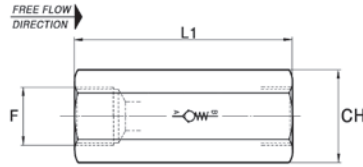

- ✓ Ex Stock
- 🔧 UK Assembly
- ☎ Please Call Sales Office

Technical Data

Materials

FT 260/6: Zinc-Plated Carbon Steel
 ATR Series: Zinc-Plated Carbon Steel
 FT 2260: Stainless Steel/VITON
 ATR-X: Stainless Steel (316)

Cracking Pressure

FT: 0.35 BAR or 4.5 BAR
 ATR: 0.35/1.5/2.5/4/6 BAR

Operating Temperature

-20°C - to +100°C

Special Requests

For assistance, contact our technical office or your local Camozzi distributor.

FT 260/6 - Carbon Steel

F	CH	L1	Max. Working Pressure (bar)	Max. Rated Flow (l/min)	Min. Burst Pressure (bar)	Part Number	
1/8	16	41	400	30	1600	FT260/6-G18	✓
1/4	19	54	400	38	1600	FT260/6-G14	✓
3/8	24	65	400	66	1600	FT260/6-G38	✓
1/2	30	77	400	130	1600	FT260/6-G12	✓
3/4	36	88	400	162	1600	FT260/6-G34	✓
1	46	108.5	320	166	1300	FT260/6-G100	✓

FT 2260/6 - Stainless Steel

F	CH	L1	Max. Working Pressure (bar)	Max. Rated Flow (l/min)	Min. Burst Pressure (bar)	Part Number	
1/8	16	41	400	30	1600	FT2260/6-G18	✓
1/4	19	54	400	38	1600	FT2260/6-G14	✓
3/8	24	65	400	66	1600	FT2260/6-G38	✓
1/2	30	77	400	130	1600	FT2260/6-G12	✓
3/4	36	88	400	162	1600	FT2260/6-G34	✓
1	46	108.5	320	166	1300	FT2260/6-G100	✓

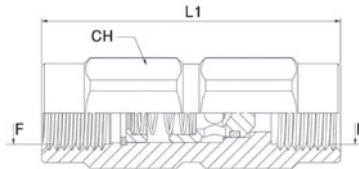

- ✓ Ex Stock
- 🔧 UK Assembly
- ☎ Please Call Sales Office

ATR - Carbon Steel

F	DN	CH	L1	Max. Working Pressure (bar)	Max. Rated Flow (l/min)	Min. Burst Pressure (bar)	Part Number	
1/8	04	14	44	300	8	1200	ATR-G18	✓
1/4	06	19	56	300	26	1200	ATR-G14	✓
3/8	10	22	70	300	44	1200	ATR-G38	✓
1/2	13	30	77	300	90	1200	ATR-G12	✓
3/4	20	36	90	300	152	1200	ATR-G34	✓
1	25	46	106	300	200	1200	ATR-G100	✓
1 1/4	32	55	125	300	370	1200	ATR-G114	✓
1 1/2	40	60	140	300	598	1200	ATR-G112	✓
2	50	75	160	200	875	800	ATR-G200	✓

ATR-X - Stainless Steel

F	DN	CH	L1	Max. Working Pressure (bar)	Max. Rated Flow (l/min)	Min. Burst Pressure (bar)	Part Number	
1/8	04	14	44	300	8	1200	ATR-X-G18	✓
1/4	06	19	56	300	26	1200	ATR-X-G14	✓
3/8	10	22	70	300	44	1200	ATR-X-G38	✓
1/2	13	30	77	300	90	1200	ATR-X-G12	✓
3/4	20	36	90	300	152	1200	ATR-X-G34	✓
1	25	46	106	300	200	1200	ATR-X-G100	✓
1 1/4	32	55	125	300	370	1200	ATR-X-G114	✓
1 1/2	40	60	140	300	598	1200	ATR-X-G112	✓
2	50	75	160	200	875	800	ATR-X-G200	✓

Flow Control & Needle Valves

Connections: 1/8 - 1 1/2 BSP

Inline needle valves with micrometer scale

HYDRAULIC VALVES & ACCESSORIES



- ✓ Ex Stock
- ✎ UK Assembly
- ☎ Please Call Sales Office

DV Series, Double Acting Flow Control & Shut-off (Bi-directional)

Part Number		BSP	BAR	LPM MAX
DV-G18	✓	1/8	350	10
DV-G14	✓	1/4	350	50
DV-G38	✓	3/8	350	75
DV-G12	✓	1/2	350	140
DV-G34	✓	3/4	350	175
DV-G100	✓	1	350	350
DV-G114	✓	1 1/4	350	350
DV-G112	✓	1 1/2	350	350

Technical Data

Materials

DV/DRV: Zinc-Plated Carbon Steel, Nitrile seals

FT: Nickel plated brass (stainless steel where stated), Nitrile seals

Operating Pressure

DV/DRV: 350 BAR

FT: 210 BAR

Operating Temperature

-20°C - to +100°C

Special Requests

For assistance, contact our technical office or your local Camozzi distributor.



- ✓ Ex Stock
- ✎ UK Assembly
- ☎ Please Call Sales Office

DRV Series, Single Acting Flow Control, Free reverse Flow (Uni-directional)

Part Number		BSP	BAR	LPM MAX
DRV-G18	✓	1/8	350	10
DRV-G14	✓	1/4	350	50
DRV-G38	✓	3/8	350	75
DRV-G12	✓	1/2	350	140
DRV-G34	✓	3/4	350	175
DRV-G100	✓	1	350	350
DRV-G114	✓	1 1/4	350	350
DRV-G112	✓	1 1/2	350	350
DRV-G200	✓	2	350	350

- ✓ Ex Stock
- ✎ UK Assembly
- ☎ Please Call Sales Office

Bi-directional Fine flow control			Part Number	
BSP	BAR	LPM	Brass	
1/8	210	0-3 fine control	FT 1237/2-18	✓



Bi-directional Flow control & shut off			Part Number		Part Number	
BSP	BAR	LPM	Brass		Stainless Steel	
1/8	210	10	FT 1251/2-18	✓	-	
1/4	210	20	FT 1251/2-14	✓	FT 2251/2-14	✓
3/8	210	30	FT 1251/2-38	✓	FT 2251/2-38	✓
1/2	210	60	FT 1251/2-12	✓	FT 2251/2-12	✓
3/4	210	80	FT 1251/2-34	✓	FT 2251/2-34	✓



Bi-directional 90° Mount Flow control & shut off			Part Number	
BSP	BAR	LPM	Brass	
1/8	210	10	FT 1252/2-18	✓
1/4	210	20	FT 1252/2-14	✓
3/8	210	30	FT 1252/2-38	✓
1/2	210	60	FT 1252/2-12	✓



Uni-directional Fine flow control			Part Number	
BSP	BAR	LPM	Brass	
1/8	210	0-3 fine control	FT 1237/5-18	✓



Uni-directional Flow control			Part Number	
BSP	BAR	LPM	Brass	
1/4	210	20	FT 1251/5-14	✓
3/8	210	30	FT 1251/5-38	✓
1/2	210	60	FT 1251/5-12	✓
3/4	210	80	FT 1251/5-34	✓



Uni-directional Flow control			Part Number	
BSP	BAR	LPM	Brass	
1/8	210	10	FT 1253/5-18	✓
1/4	210	20	FT 1253/5-14	✓
3/8	210	30	FT 1253/5-38	✓
1/2	210	60	FT 1253/5-12	✓
3/4	210	80	FT 1253/5-34	✓



Uni-directional 90° Mount Flow control			Part Number	
BSP	BAR	LPM	Brass	
1/8	210	10	FT 1254/5-18	✓
1/4	210	20	FT 1254/5-14	✓
3/8	210	30	FT 1254/5-38	✓
1/2	210	60	FT 1254/5-12	✓



INDUSTRY LEADING **PNEUMATIC CYLINDER SERVICE**



The quickest way to get a cylinder in the UK

Getting a pneumatic cylinder fast doesn't have to be stressful.

Camozzi's UK-based cylinder production enables most standard and non-standard cylinders in any bore or stroke variation, to be built within a same day or next day window, with no additional surcharge.

In the event of a potentially costly breakdown situation, Camozzi is equipped to offer a one hour cylinder build service, enabling customers to get back up and running with minimal disruption.

Camozzi Automation
A Camozzi Group Company

Standard & non-standard strokes



Includes many cylinder types

Totally flexible delivery and collection options



Camozzi Automation Ltd
The Fluid Power Centre
Watling Street, Nuneaton
Warwickshire, CV11 6BQ
024 7637 4114
askus@camozzi.co.uk
www.camozzi.co.uk
store.camozzi.co.uk

Tubing

1 Nylon

	Page
 Flexible and Extra Flexible Nylon Tubing	343
 C-Truck Air Brake Nylon Tubing	344
 Flexible Nylon Recoils	345

2 PVC Hose

	Page
 Reinforced PVC Braided Hose	346
 PVC Hose	347
 PV Tubing	348

3 Pneumatic Polyurethane Tubing

	Page
 Pneumatic Polyurethane Tubing	348

4 PTFE Tubing

	Page
 PTFE Tubing	349

5 Accessories

 Tube Cutters and Clamps	349
---	-----

Flexible and Extra Flexible Nylon Tubing

30m coil (BS5409)

Applications: Both flexible and extra flexible nylon tubing is manufactured from high quality nylon granules.

These are ideally suited for use with push-in fittings and for a wide range of industrial applications.

Compressed air, lubrication, refrigeration, air conditioning, coolant lines, fuels and oils (TRN and TRM).

Pneumatic controls and instrumentation systems (TRXN).

- ✓ Ex Stock
- ✎ UK Assembly
- 📞 Please Call Sales Office



Flexible Nylon Tubing - Metric	Availability	OD mm	ID mm	Working Pressure psi	Working Pressure bar
TRN 4/2.5*	✓	4	2.5	400	27
TRN 4/3#	✓	4	3	260	18
TRN 5/3*	✓	5	3	400	24
TRN 6/4*	✓	6	4	350	24
TRN 8/5.5*	✓	8	5.5	335	23
TRN 8/6*	✓	8	6	255	17
TRN 10/7*	✓	10	7	320	22
TRN 10/8*	✓	10	8	200	14
TRN 12/9*	✓	12	9	260	18
TRN 12/10*	✓	12	10	160	11
TRN 14/11†	✓	14	11	210	14
TRN 15/12.5†	✓	14	12.5	195	13
TRN 16/13#	Ⓞ	16	13	200	14
TRN 22/17#	Ⓞ	22	17	235	16
TRN 28/22#	Ⓞ	28	22	220	15

Flexible Nylon Tubing - Imperial	Availability	OD inch	ID inch	Working Pressure psi	Working Pressure bar
TRM 1/8#	Ⓞ	1/8	.058	350	23
TRM 3/16*	Ⓞ	3/16	.117	350	23
TRM 1/4*	Ⓞ	1/4	.170	350	23
TRM 5/16*	Ⓞ	5/16	.212	350	23
TRM 3/8*	Ⓞ	3/8	.250	350	23
TRM 1/2*	Ⓞ	1/2	.375	250	17
TRM 5/8#	Ⓞ	5/8	.5	200	13
TRM 3/4#	Ⓞ	3/4	.594	200	13
TRM 1#	Ⓞ	1	.813	200	13

Extra Flexible Nylon Tubing - Metric	Availability	OD mm	ID mm	Working Pressure psi	Working Pressure bar
TRXN 4/2.5*	Ⓞ	4	2.5	220	15
TRXN 5/3#	Ⓞ	5	3	250	17
TRXN 6/4*	Ⓞ	6	4	200	13
TRXN 8/5.5#	Ⓞ	8	5.5	160	11
TRXN 10/8#	Ⓞ	10	7	160	11
TRXN 12/9*	Ⓞ	12	9	130	9

*TRN, TRM and TRXN tubing is supplied in natural as standard. The tube sizes marked * are available in natural, black, red, blue, green and yellow. Please specify colour when ordering.

#Only available in natural.

†Only available in natural or blue.

Technical Data
Standard Coil Lengths
30 metres
Other lengths and drums available on request

Materials
Manufactured from nylon 12

Operating Temperature
-35°C to +70°C
Brittle temperature: -70°C

Working Pressure
Values stated are based on the short term burst pressure of nylon at 20°C using a 4:1 safety factor.
For data over 20°C, contact our sales office

Bend Radius
For information regarding this data, contact our sales office

Chemical Resistance
Resistant to most solvents, alkalis, oils, greases, petroleum products, and dilute acids (mineral and organic).
For further information, contact our sales office

This product range is not suitable for food and drinks applications - see page 347

Technical Advice
For assistance, contact our technical office or your local Camozzi distributor.

C-Truck Air Brake Nylon Tubing

Manufactured and printed to DIN 73378 except black tube which complies to air brake standards DIN 74324. It is also printed with depth marks and is suitable for use with air, water, petrol, diesel and many other chemicals.

- ✓ Ex Stock
- ✂ UK Assembly
- 📞 Please Call Sales Office



TUBING

C-Truck Air Brake Nylon Tubing - Metric	OD	ID	Working	Working
Availability	mm	mm	Pressure psi	Pressure bar
TRN 4/2 NX*	Ⓞ	4	2	900 27
TRN 6/4 NX*	Ⓞ	6	4	350 24
TRN 8/6 NX*†	Ⓞ	8	6	255 17
TRN 10/8 NX*†	Ⓞ	10	8	200 14
TRN 12/9 NX*†	Ⓞ	12	9	260 18
TRN 15/12 NX	Ⓞ	15	12	200 13
TRN 16/13 NX	Ⓞ	16	13	200 14
TRN 18/14 NX	Ⓞ	18	14	250 17

Supplied in black as standard.

The tube sizes marked * are also available in natural, red, blue.

The tube sizes marked † are also available in yellow.

Please specify colour when ordering.

Technical Data

Standard Coil Lengths

15 metres

Other lengths available on request

Materials

Manufactured from nylon 12

Operating Temperature

-35°C to +70°C

Brittle temperature: -70°C

Working Pressure

Values stated are based on the short term burst pressure of nylon at 20°C using a 4:1 safety factor.

For data over 20°C, contact our sales office

Bend Radius

For information regarding this data, contact our sales office

Chemical Resistance

Resistant to most solvents, alkalis, oils, greases, petroleum products, and dilute acids (mineral and organic).

For further information, contact our sales office

Approvals

Manufactured and printed to DIN 73378 except black tube which complies to air brake standards DIN 74324

Technical Advice

For assistance, contact our technical office or your local Camozzi distributor.

UK Cylinder Service



Reduce Lead Times for Pneumatic Cylinders

- Built the same or next day
- Includes many cylinder types

Flexible Nylon Recoils

Tubing to (BS5409)

- ✓ Ex Stock
- 🔧 UK Assembly
- 📞 Please Call Sales Office

Applications: TRNR flexible nylon recoils are manufactured from high quality nylon granules and are suitable for use in a wide range of pneumatic applications. Flexible nylon recoils are fitted with BSPT swivel fittings and anti-kink tube nuts as standard.



TUBING

Technical Data

Standard Coil Lengths

See table

Other lengths available on request

Materials

TRNR coils are manufactured from nylon 12

Operating Temperature

-35°C to +70°C

Brittle temperature: -70°C

Working Pressure

Values stated are based on the short term burst pressure of nylon at 20°C using a 4:1 safety factor.

For data over 20°C, contact our sales office

Chemical Resistance

Resistant to most solvents, alkalis, oils, greases, petroleum products, and dilute acids (mineral and organic).

For further information, contact our sales office

Approvals

Tubing manufactured to BS5409 (1)

This product range is not suitable for food and drinks applications

Technical Advice

For assistance, contact our technical office or your local Camozzi distributor.

Flexible Nylon Tubing - Metric Availability	OD mm	ID mm	Working Length metre	BSPT Swivel Fitting	Working Pressure bar	
TRNR-0602	✓	6	4	2.5	1/4	24
TRNR-0605	✓	6	4	5	1/4	24
TRNR-0610	✓	6	4	10	1/4	24
TRNR-0615	✓	6	4	15	1/4	24
TRNR-0802	✓	8	6	2.5	1/4	17
TRNR-0805	✓	8	6	5	1/4	17
TRNR-0810	✓	8	6	10	1/4	17
TRNR-0815	✓	8	6	15	1/4	17
TRNR-1002	✓	10	8	2.5	3/8	14
TRNR-1005	✓	10	8	5	3/8	14
TRNR-1010	✓	10	8	10	3/8	14
TRNR-1015	✓	10	8	15	3/8	14
TRNR-1202	✓	12	9	2.5	3/8	11
TRNR-1205	✓	12	9	5	3/8	11
TRNR-1210	✓	12	9	10	3/8	11
TRNR-1215	✓	12	9	15	3/8	11

Flexible nylon recoils are available without BSPT swivel fittings on request. Please note: not suitable for constant rotation.

Reinforced PVC Braided Hose

30m Coils

- ✓ Ex Stock
- ✂ UK Assembly
- 📞 Please Call Sales Office

PVCB reinforced braided hose is a quality product range offering both high working pressures and extreme flexibility.

This hose is suitable for a wide range of industrial applications including factory airlines, pneumatic and hydraulic applications, food and drinks industry, chemicals and water.

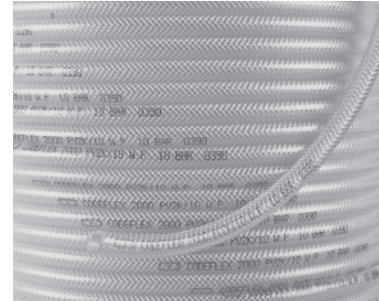

	Availability	Hose ID mm	Hose OD mm	Colour	Working Pressure bar
PVCB 3C	📞	3	8	Clear	32
PVCB 4C	📞	4	9	Clear	27
PVCB 5C	📞	5	10	Clear	20
PVCB 5N	📞	5	10	Black	20
PVCB 6C	📞	6	11	Clear	10
PVCB 6N	📞	6	11	Black	10
PVCB 6R	📞	6	11	Red	10
PVCB 6B	📞	6	11	Blue	10
PVCB 6G	📞	6	11	Green	10
PVCB 6Y	📞	6	11	Yellow	10
PVCB 8C	📞	8	12	Clear	10
PVCB 8N	📞	8	12	Black	10
PVCB 8R	📞	8	12	Red	10
PVCB 8B	📞	8	12	Blue	10
PVCB 8G	📞	8	12	Green	10
PVCB 8Y	📞	8	12	Yellow	10
PVCB 10C	📞	10	14	Clear	10
PVCB 10N	📞	10	14	Black	10
PVCB 10R	📞	10	14	Red	10
PVCB 10B	📞	10	14	Blue	10
PVCB 10G	📞	10	14	Green	10
PVCB 10Y	📞	10	14	Yellow	10
PVCB 12C	📞	12	18	Clear	10
PVCB 12N	📞	12	18	Black	10
PVCB 12R	📞	12	18	Red	10
PVCB 12B	📞	12	18	Blue	10
PVCB 12G	📞	12	18	Green	10
PVCB 12Y	📞	12	18	Yellow	10
PVCB 16C	📞	16	22	Clear	10
PVCB 16N	📞	16	22	Black	10
PVCB 19C	📞	19	25	Clear	10
PVCB 19N	📞	19	25	Black	10
PVCB 19R	📞	19	25	Red	10
PVCB 19B	📞	19	25	Blue	10
PVCB 25C	📞	25	32	Clear	10
PVCB 25N	📞	25	32	Black	10
PVCB 32C	📞	32	42	Clear	6
PVCB 38C	📞	38	49	Clear	6
PVCB 50C	📞	50	62	Clear	3

Technical Data

Standard Coil Lengths

30 metres

Other lengths available on request

Materials

PVCB is manufactured from crystal clear PVC compound, and is reinforced with 1000 denier polyester fibre yarn

Operating Temperature

-15°C to +60°C

Working Pressure

Values stated are based on the short term burst pressure of PVC at 20°C using a 3:1 safety factor.

For data over 20°C, contact our sales office

Bend Radius

For information regarding this data, contact our sales office

Chemical Resistance

Resistant to most oxidising and reducing agents including dilute acids and alkalis.

For further information, contact our sales office

Approvals

Raw materials used have FDA, BGA and BIPRA approval for use with food stuffs

Technical Advice

For assistance, contact our technical office or your local Camozzi distributor.

PVC Hose

30m Coils

PVC unreinforced hose is a quality product range offering extreme flexibility.

This hose is suitable for a wide range of applications including chemical delivery, laboratory use, sight glasses, instrumentation, drainage hoses and the delivery of food and beverages (beer).

- ✓ Ex Stock
- 🔧 UK Assembly
- 📞 Please Call Sales Office



	Availability	Hose ID mm	Hose OD mm	Colour
PVCL 3C	📞	3	6	Clear
PVCL 5C	📞	5	8	Clear
PVCL 6C	📞	6	9	Clear
PVCL 8C	📞	8	11	Clear
PVCL 10C	📞	10	13	Clear
PVCL 12C	📞	12	15	Clear
PVCL 16C	📞	16	19	Clear
PVCM 4C	📞	4	10	Clear
PVCM 5C	📞	5	11	Clear
PVCM 6C	📞	6	12	Clear
PVCM 8C	📞	8	14	Clear
PVCM 10C	📞	10	16	Clear
PVCM 22C	📞	22	28	Clear
PVCM 25C	📞	25	31	Clear
PVCH 38C	📞	38	47	Clear

Technical Data

Standard Coil Lengths

30 metres

Other lengths available on request

Materials

PVC is manufactured from crystal clear PVC compound

Operating Temperature

-15°C to +60°C

Working Pressure

For pressure applications we recommend the use of reinforced PVCB tubing.

Unreinforced PVC is NOT recommended for use in pressure applications

Bend Radius

For information regarding this data, contact our sales office

Chemical Resistance

Resistant to most oxidising and reducing agents including dilute acids and alkalis.

For further information, contact our sales office

Approvals

Raw materials used have FDA, BGA and BIPRA approval for use with foodstuffs

Technical Advice

For assistance, contact our technical office or your local Camozzi distributor.

PV Tubing

25m Coils

PV tubing is manufactured from high quality PVC. PV tubing is flexible and lightweight, making it ideally suited to a wide range of industrial applications, particularly air tools. For use with Rapid fitting and pipe adaptors.

- ✓ Ex Stock
- ✂ UK Assembly
- 📞 Please Call Sales Office



Technical Data

Standard Coil Lengths

25 metres

Materials

PV is manufactured from high quality PVC

Operating Temperature

-10°C to +60°C

Brittle temperature: -20°C

Working Pressure

Values stated are based on the short term burst pressure of PVC at 30°C. For data over 30°C, contact our sales office

Bend Radius

For information regarding this data, contact our sales office

Chemical Resistance

Resistant to most oxidising and reducing agents including dilute acids and alkalis.

For further information, contact our sales office

Technical Advice

For assistance, contact our technical office or your local Camozzi distributor.

Flexible PVC Tubing - Metric Availability	OD mm	ID mm	Colour	Working Pressure psi	Working Pressure bar
PV 6/4 ✓	6	4	Blue	375	25
PV 8/6 ✓	8	6	Blue	375	25
PV 10/8 ✓	10	8	Blue	375	25
PV 12/10 ✓	12	10	Blue	375	25
PV 15/12.5 ✓	15	12.5	Blue	375	25

Pneumatic Polyurethane Tubing

30m Coils

PU tubing is manufactured from ester based polyurethane. PU tubing is ideally suited for use with Rapid and push-in fittings, but is also suitable for a wide range of industrial applications, particularly industrial robotics, control instrumentation and hydraulic lines.

- ✓ Ex Stock
- ✂ UK Assembly
- 📞 Please Call Sales Office



Technical Data

Standard Coil Lengths

30 metres

Other lengths available on request

Materials

PU is manufactured from 100% ester based polyurethane

Operating Temperature

-50°C to +80°C

Note: in hot and humid conditions, hydrolysis will occur

Working Pressure

Values stated are based on the short term burst pressure of PU at 20°C. For data over 20°C, contact our sales office

Bend Radius

For information regarding this data, contact our sales office

Chemical Resistance

Resistant to most fuels, oils, greases and many other solvents, chemicals and gases.

For further information, contact our sales office

Technical Advice

For assistance, contact our technical office or your local Camozzi distributor.

Polyurethane Tubing - Metric Availability	OD mm	ID mm	Working Pressure psi	Working Pressure bar
PU 4/2.5 ✓	4	2.5	190	12
PU 6/4 ✓	6	4	160	10
PU 8/5 ✓	8	5	160	10
PU 10/7.5 ✓	10	7.5	120	8
PU 12/9 ✓	12	9	120	8

Available in the following colours: blue (standard), clear, black, red, green and white
Please state colour when ordering.

PTFE Tubing

50m and 100m Coils

PTFE tubing is manufactured from polytetrafluoroethylene granules. PTFE tubing is ideally suited to the transport of harsh chemicals, printing equipment, analytical instruments, environmental monitoring equipment and abrasion protection.

- ✓ Ex Stock
- ✎ UK Assembly
- 📞 Please Call Sales Office

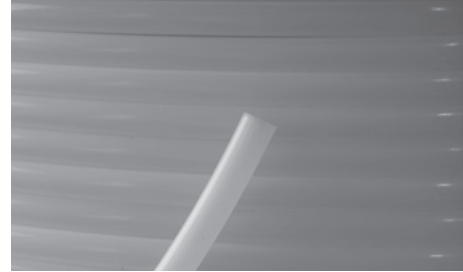

PTFE Tubing - Metric		OD	ID	Working	Working
	Availability	mm	mm	Pressure psi	Pressure bar
PT 4/2.5	📞	4	2.5	180	12
PT 6/4	📞	6	4	180	12
PT 8/6	📞	8	6	135	9
PT 10/8	📞	10	8	105	7
PT 12/10	📞	12	10	75	5

Technical Data

Standard Coil Lengths

100 metres
25m and 50m available on request

Materials

PTFE is manufactured from polytetrafluoroethylene granules

Operating Temperature

-200°C to +260°C
Melting point: +327°C

Working Pressure

Values stated are based on the short term burst pressure of PTFE at 20°C using a safety factor of 4:1. For data over 20°C, contact our sales office

Bend Radius

For information regarding this data, contact our sales office

Chemical Resistance

PTFE tubing is suitable for use with virtually any corrosive material. For further information, contact our sales office

Technical Advice

For assistance, contact our technical office or your local Camozzi distributor.

Accessories



Tube Cutters	
PNZ 12	✓
PNZ 25	✓



Plastic Tube Cutters	
PNZP-12	✓



Tube Clamp		
MPL	4	✓
MPL	6	✓
MPL	8	✓
MPL	10	✓



For Cylinders
from page 3



For Valves
from page 69



For Fittings
from page 252

Pneumatic Symbols

Symbol	Type	Symbol	Type
CYLINDERS			
CD01	Double-acting cylinder, fixed cushions	CS01	Single-acting cylinder, front spring
CD02	Double-acting cylinder, cushioned	CS02	Single-acting cylinder, front spring
CD03	Double-acting cylinder, adjustable rear cushion	CS03	Single-acting cylinder, non cushioned
CD04	Double-acting cylinder, adjustable front cushion	CS04	Single-acting cylinder, through-rod
CD05	Double-acting cylinder, through-rod, fixed cushions	CS05	Single-acting cylinder, through-rod, adjustable cushion
CD06	Double-acting cylinder, through-rod, adjustable front and rear cushion	CS06	Single-acting cylinder, magnetic
CD07	Double-acting cylinder, magnetic	CS07	Single-acting cylinder, front spring, adjustable rear cushion
CD08	Double-acting cylinder, magnetic, fixed cushions	CS08	Single-acting cylinder, rear spring, magnetic
CD09	Double-acting cylinder, magnetic, adjustable cushions in both directions	CS09	Single-acting cylinder, magnetic, front spring
CD10	Double-acting cylinder, magnetic, adjustable rear cushion	CS10	Single-acting cylinder, through-rod
CD11	Double-acting cylinder, magnetic, adjustable front cushion	CS11	Single-acting cylinder, through-rod, adjustable rear cushion
CD12	Double-acting cylinder, magnetic, through-rod, fixed cushions	CS12	Single-acting cylinder, front spring, adjustable rear cushion
CD13	Double-acting cylinder, magnetic, through-rod, adjustable cushions in both directions	CS13	Single-acting cylinder, through-rod, adjustable rear cushion
CD14	Double-acting cylinder, magnetic, through-rod	HI01	Hydrocheck, regulated rod thrust
CD15	Magnetic twin rod cylinders	HI02	Hydrocheck, regulated rod return
CD16	Magnetic twin through-rod cylinders	HI03	Hydrocheck, regulated rod thrust with stop valve
CD17	Double-acting rotary cylinder	HI04	Hydrocheck, regulated rod return with stop valve
CD18	Double-acting rotary cylinder, magnetic	HI05	Hydrocheck, regulated rod thrust with skip valve
CD19	Single-acting rotary cylinder	HI06	Hydrocheck, regulated rod return with skip valve
CD2T	Magnetic tandem cylinder, two stages, fixed cushions single rear supply, sole front supply	HI07	Hydrocheck, regulated rod thrust with skip and stop valve
CD3T	Magnetic tandem cylinder, three stages, fixed cushions single rear supply, sole front supply	HI08	Hydrocheck, regulated rod return with skip and stop valve
CD4T	Magnetic tandem cylinder, four stages, fixed cushions single rear supply, sole front supply	PNZ1	Double-acting magnetic grippers
CD5T	Magnetic tandem cylinder, two stages, fixed cushions, separated rear supplies, sole front supply	RDLK	Rod lock device
CD6T	Magnetic tandem cylinder, three stages, fixed cushions, single rear supplies, sole front supply	SOLENOID VALVES	
CD7T	Magnetic tandem cylinder, two stages, fixed cushions, single rear supplies, sole front supply	EV01	Directly operated solenoid valve, 2/2 NC
CD8T	Magnetic tandem cylinder, two stages, fixed cushions, separated rear and front supplies	EV02	Directly operated solenoid valve, 2/2 NO
CD9T	Non magnetic tandem cylinder, two stages, fixed cushions, separated rear and front supplies	EV03	Directly operated solenoid valve, 3/2 NC
CDPP	Magnetic multi-position cylinder, fixed cushions	EV04	Directly operated solenoid valve, 3/2 NC, monostable, with manual override
CDSS	Double-acting rodless cylinder, magnetic	EV05	Directly operated solenoid valve, 3/2 NO

Symbol	Type
SOLENOID VALVES	
EV06	Directly operated solenoid valve, 3/2 NO, monostable, with manual override
EV07	Solenoid valve, 3/2 NC with quick exhaust
EV08	Directly operated solenoid valve, 3/2 NC, bistable, with manual override
EV09	Directly operated solenoid valve, 3/2 NO, bistable, with manual override
EV10	Solenoid valve, 3/2 NC, monostable, with bistable manual override
EV11	Solenoid valve, 3/2, monostable, solenoid pilot with separate air supply and bistable manual override
EV12	Solenoid valve, 3/2 NO, monostable, with bistable manual override
EV13	Solenoid valve, 3/2, monostable, solenoid pilot with separate air supply and bistable manual override
EV14	Solenoid valve, 3/2, bistable, with manual override bistable
EV15	Solenoid valve, 3/2, bistable, solenoid pilot with separate air supply and bistable manual override
EV16	Solenoid valve, 3/2 NC, monostable, (pneumatic spring) and bistable manual override
EV17	Solenoid valve, 3/2 NO, monostable, (pneumatic spring) and bistable manual override
EV18	Solenoid valve, 5/2, monostable, with bistable manual override
EV19	Solenoid valve, 5/2, monostable, solenoid pilot with separate air supply and bistable manual override
EV20	Solenoid valve, 5/2, monostable, (pneumatic spring) and manual override
EV21	Solenoid valve, 5/2, monostable, (pneumatic spring) and bistable manual override
EV22	Solenoid valve, 5/2, monostable, solenoid pilot with separate air supply, pneumatic spring and bistable manual override
EV23	Solenoid valve, 5/2, bistable, with bistable manual override
EV24	Solenoid valve, 5/2, bistable, with manual override
EV25	Solenoid valve, 5/2, bistable, solenoid pilot with separate air supply and bistable manual override
EV26	Solenoid valve, 5/2, bistable, solenoid pilot with separate air supply and bistable manual override
EV27	Solenoid valve, 5/3 CC, with manual override
EV28	Solenoid valve, 5/3 CC, with bistable manual override
EV29	Solenoid valve, 5/3, solenoid pilot with separate air supply and bistable manual override
EV30	Solenoid valve, 5/3, solenoid pilot with separate air supply and bistable manual override
EV31	Solenoid valve, 5/3 CO, with manual override
EV32	Solenoid valve, 5/3 CO, with bistable manual override
EV33	Solenoid valve, 5/3 CO, solenoid pilot with separate air supply and bistable manual override
EV34	Solenoid valve, 5/3 CO, solenoid pilot with separate air supply and bistable manual override
EV35	Solenoid valve, 5/3 CP, with manual override

Symbol	Type
SOLENOID VALVES	
EV36	Solenoid valve, 5/3 CP, with bistable manual override
EV37	Solenoid valve, 5/3 CP, solenoid pilot with separate air supply and bistable manual override
EV38	Solenoid valve, 5/3 CP, solenoid pilot with separate air supply and bistable manual override
EV39	Double solenoid valve, 3/2 NC, monostable, with bistable manual override
EV40	Double solenoid valve, 3/2, monostable, solenoid pilot with separate air supply and bistable manual override
EV41	Double solenoid valve, 3/2 NO, monostable, with bistable manual override
EV42	Double solenoid valve, 3/2, monostable, solenoid pilot with separate air supply and bistable manual override
EV43	Double solenoid valve, 3/2 NC, NO, monostable, with bistable manual override
EV44	Double solenoid valve, 3/2, monostable, solenoid pilot with separate air supply and bistable manual override
EV45	Directly operated solenoid valve, 3/2, possible universal use, reversed printed ports 1 and 2 on the body
EV46	Indirectly operated solenoid valve, 2/2 NO
EV47	Directly operated solenoid valve, 2/2 NC, with linked diaphragm
EV48	Indirectly operated solenoid valve, 2/2 NC
EV49	Indirectly operated Booster solenoid valve, 2/2 NC
EV50	Indirectly operated Booster solenoid valve, 2/2 NO
EV51	Indirectly operated Booster solenoid valve, 3/2 NC
EV52	Indirectly operated Booster solenoid valve, 3/2 NO

PROPORTIONAL VALVES	
ER01	Proportional regulator
AP01	Directly operated proportional valve
LR1	Servo valves
K8P1	Series K8P proportional micro-valve

PNEUMATICALLY OPERATED VALVES	
VP01	Pneumatically operated valve, 3/2, monostable, mechanical spring
VP02	Pneumatically operated valve, 3/2, bistable
VP03	Pneumatically operated valve, 3/2, preferential
VP04	Pneumatically operated valve, 5/2, monostable, mechanical spring
VP05	Pneumatically operated valve, 5/2, preferential

Symbol	Type
PNEUMATICALLY OPERATED VALVES	
VP06	Pneumatically operated valve, 5/2, bistable
VP07	Pneumatically operated valve, 5/2, monostable, pneumatic spring
VP08	Pneumatically operated valve, 5/3 CC
VP09	Pneumatically operated valve, 5/3 CO
VP10	Pneumatically operated valve, 5/3 CP
VP11	Pneumatically operated double valve, 3/2, monostable
VP12	Pneumatically operated double valve, 3/2, monostable
VP13	Pneumatically operated double valve, 3/2, monostable

MECHANICALLY OPERATED VALVES	
VM01	Mechanically operated valve, plunger actuation, 3/2 NC, monostable, mechanical spring
VM02	Mechanically operated valve, plunger actuation, 3/2, monostable, mechanical spring
VM03	Mechanically operated valve, lever/roller actuation, 3/2 NO, monostable, mechanical spring
VM04	Mechanically operated valve, lever/roller actuation, 3/2 NC, monostable, mechanical spring
VM05	Mechanically operated valve, lever/roller actuation, 3/2, monostable, mechanical spring
VM06	Mechanically operated valve, lever/roller actuation, 3/2 NO, monostable, mechanical spring
VM07	Mechanically operated valve, unidirectional lever actuation, 3/2 NC, monostable, mechanical spring
VM08	Mechanically operated valve, unidirectional lever actuation, 3/2 monostable, mechanical spring
VM09	Mechanically operated valve, plunger actuation, 5/2, monostable, mechanical spring
VM10	Mechanically operated valve, plunger actuation, 5/2, monostable, mechanical spring
VM11	Mechanically operated valve, lever/roller actuation, 5/2, monostable, mechanical spring
VM12	Mechanically operated valve, lever/roller actuation, 5/2, monostable, mechanical spring
VM13	Mechanically operated valve, unidirectional lever actuation, 5/2, monostable, mechanical spring
VM14	Mechanically operated sensor valve, 3/2 NO, monostable, mechanical spring
VM15	Mechanically operated sensor valve, 3/2 NC, monostable, mechanical spring
VM16	Mechanically operated sensor valve, plunger actuation, 5/2, monostable, mechanical spring
VM17	Mechanically operated sensor valve, 5/2, monostable, mechanical spring
VM18	Mechanically operated sensor valve, plunger actuation, 5/2, bistable
VM19	Mechanically operated sensor valve, lever/roller actuation, 5/2, monostable, mechanical spring
VM20	Mechanically operated sensor valve, lever/roller actuation, 5/2, bistable
VM21	Mechanically operated valve, front actuation, 5/2 NC, monostable, mechanical spring

Symbol	Type
MANUALLY OPERATED VALVES	
VN01	Manually operated valve, 3/2, bistable
VN02	Manually operated valve, 3/2, bistable, lockable in two positions
VN03	Manually operated valve, 3/2, bistable
VN04	Manually operated valve, 3/2 NC, monostable, mechanical spring
VN05	Manually operated valve, 3/2 NO, monostable, mechanical spring
VN06	Manually operated valve, 3/2, monostable, mechanical spring
VN07	Manually operated lever valve, 3/2, bistable
VN08	Manually operated lever valve, 3/2, bistable
VN09	Manually operated lever valve, 3/2 NC, monostable, mechanical spring
VN10	Manually operated lever valve, 3/2, bistable
VN11	Manually operated lever valve, 3/2, monostable, mechanical spring
VN12	Pedal operated valve, 3/2 NC, monostable, mechanical spring
VN13	Manually operated valve, 5/2, bistable
VN14	Manually operated valve, 5/2, monostable, mechanical spring
VN15	Manually operated lever valve, 5/2, bistable
VN16	Manually operated lever valve, 5/2, bistable
VN17	Manually operated lever valve, 5/2, monostable, mechanical spring
VN18	Pedal operated valve, 5/2, bistable
VN19	Pedal operated valve, 5/2, monostable, bistable
VN20	Manually operated lever valve, 5/3 CC, stable
VN21	Manually operated lever valve, 5/3 CC, monostable
VN22	Manually operated lever valve, 5/3 CO, stable
VN23	Manually operated lever valve, 5/3 CO, stable
VN24	Manually operated lever valve, 5/3 CO, monostable
VN25	Manually operated lever valve, Joystick

PNEUMATIC LOGIC VALVES	
AND1	"AND" pneumatic symbol
AND2	"AND" logical symbol
OR01	"OR" pneumatic symbol and circuit selector
OR02	"OR" logical symbol

Symbol	Type
PNEUMATIC LOGIC VALVES	
YES1	"YES" pneumatic symbol
YES2	"YES" logical symbol
NOT1	"NOT" pneumatic symbol
NOT2	"NOT" logical symbol
MEM1	"MEMORY" pneumatic symbol
MEM2	"MEMORY" logical symbol
AMP1	Signal amplifier, 3/2 NC, mechanical spring return
2LB1	Jet interruption sender sensor
2LB2	Jet interruption receiver sensor
AUTOMATIC VALVES	
VMP1	Maximum pressure valve
VSC1	Quick exhaust valves
VBU1	Unidirectional blocking valves
VB01	Bidirectional blocking valves
VNR1	Non return valves
VNV1	Check valve
FLOW CONTROL VALVES	
RFU1	Unidirectional flow control valve
RFO1	Bidirectional flow control valve
RP01	Unidirectional flow control valve
RP02	Unidirectional flow control valve
RP03	Bidirectional flow control valve
PRESSURE SWITCHES AND VACUUM SWITCHES	
PMNA	Pressure switch, Normally Open (NO)
PMNC	Pressure switch, Normally Closed (NC)
PMSC	Pressure switch with exchange contacts
PMTV	Pressure switch with setting visual scale
TRP1	Electro-pneumatic transducer
SEG1	Pressure indicator
CAP1	Capacity

Symbol	Type
SILENCIER	
SIL1	Silencier
RSW1	Silenced exhaust controller
FRL	
FT01	Filter without drain
FT02	Filter with manual drain
FT03	Filter with automatic drain
FA01	Coalescing filter without drain
FA02	Coalescing filter with manual drain
FA03	Coalescing filter with automatic drain
FC01	Absorption function without cup hole
PR01	Regulator without relieving
PR02	Regulator with relieving
PR03	Regulator with relieving and by-pass valve
PR04	Regulator with relieving and with by-pass valve
PR05	Regulator without relieving and with pressure gauge
PR06	Regulator with relieving and with pressure gauge
LU01	Lubricator
FR01	Filter-regulator with relieving and manual drain
FR02	Filter-regulator with relieving and without drain
FR03	Filter-regulator with relieving, manual drain and pressure gauge
FR04	Filter-regulator with relieving, without drain and with pressure gauge
FR05	Filter-regulator with relieving, automatic drain and pressure gauge
FR10	Filter-regulator with manual drain, without relieving and with pressure gauge
FR11	Filter-regulator with manual drain and without relieving
FR18	Filter-regulator with relieving and automatic drain
FR19	Manifold pressure regulator
VN02	Lockable isolation valve
AVP1	Soft start valve
BL01	Take-off block
BL02	Take-off block with VNR
VACUUM	
VU01	In-line ejector
VU02	Silenced in-line ejector
VEN1	Suction pad
FT04	Cup filter

Spring loads cylinders

Series 14 - stroke 5 mm

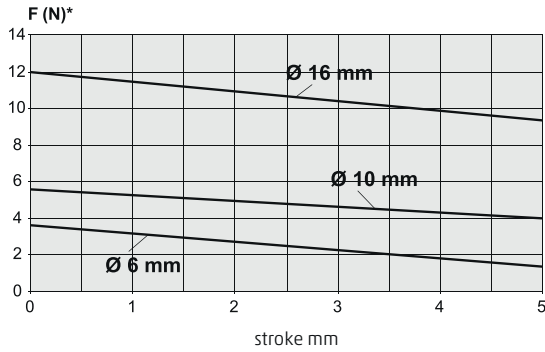

Series 14 - stroke 10 and 15 mm

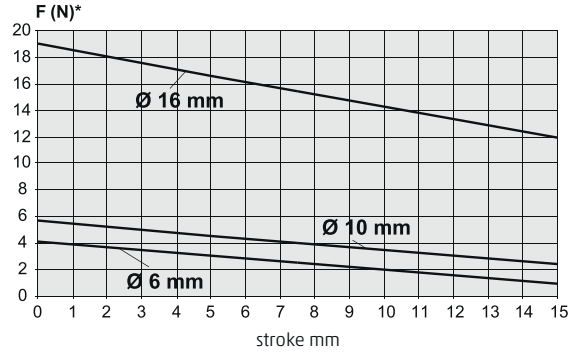

Series 16-24

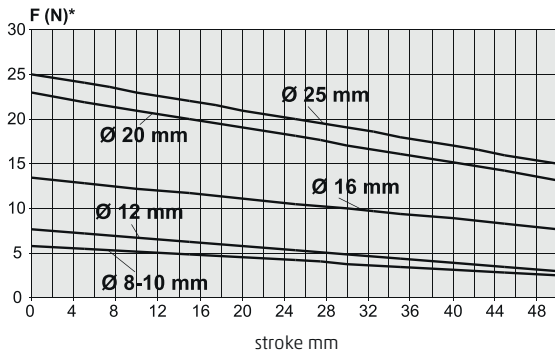

Series 31-32

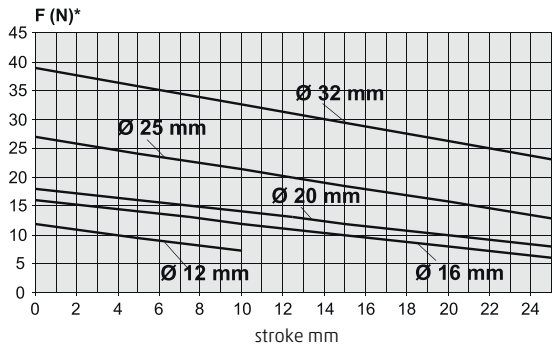

Series 31-32

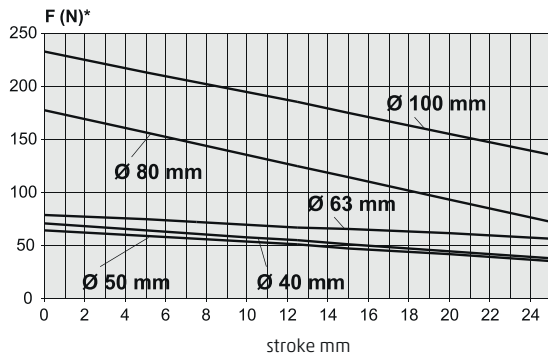

Series 60-61-42-90

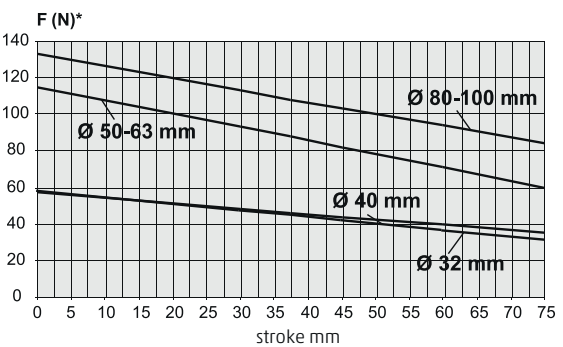

Series 63 - front spring

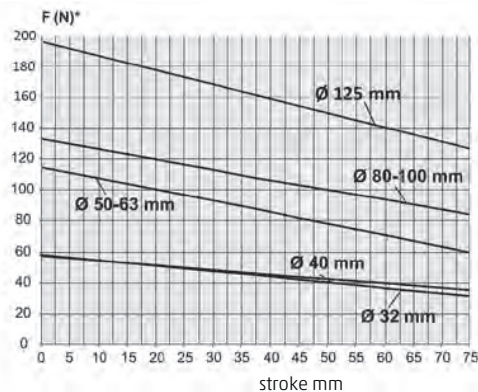

Series 63 - rear spring

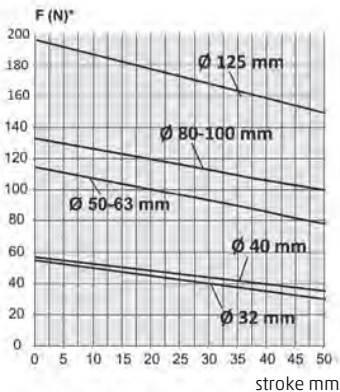

Series QP

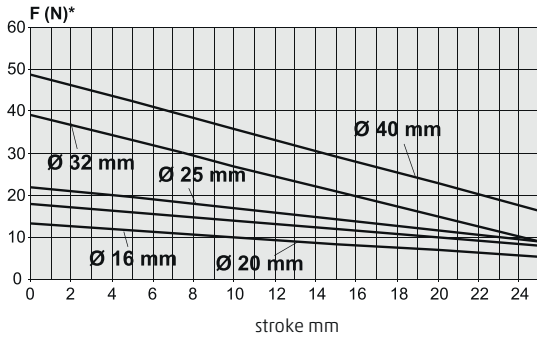

Series QP

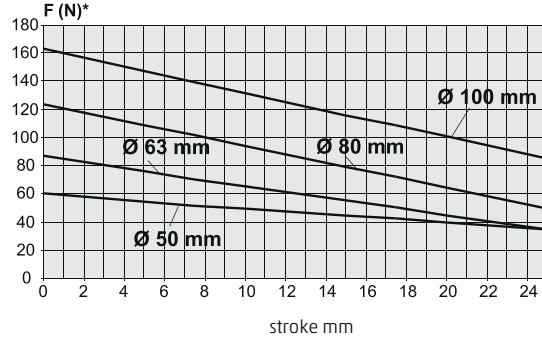

Series 90-97

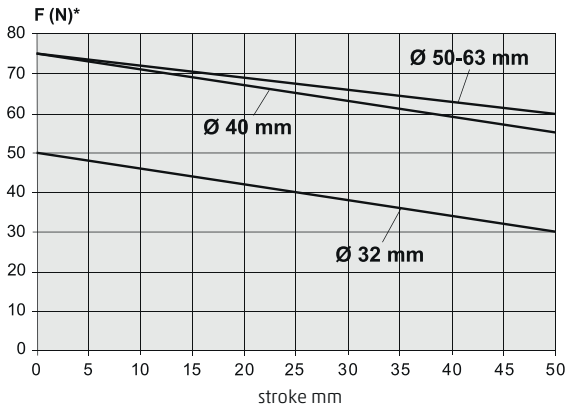

Series 94

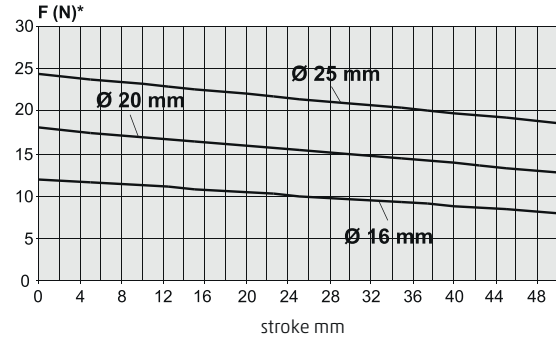

Series QN - stroke 4 and 5 mm

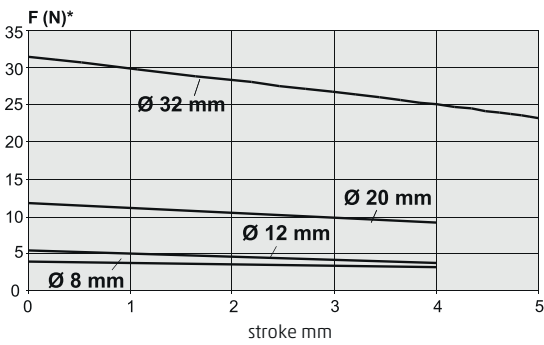

Series QN - stroke 10 mm

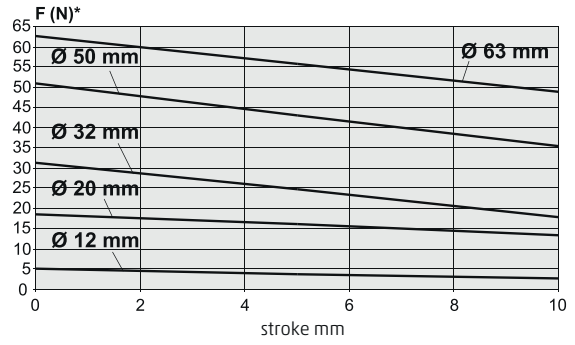

Series QN - stroke 25 mm

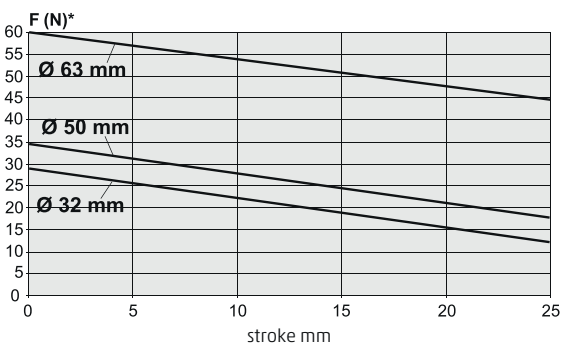

Flow and speed cylinders

Valves and solenoid valves

Flow survey instruments.

The flow rate indicated in the catalogue is obtained with
P1 = 6 bar and P2 = 5 bar.

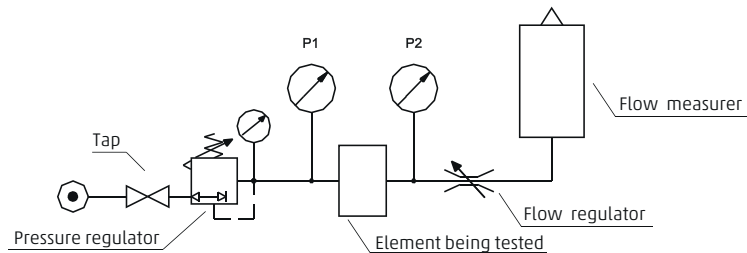

Maximum speeds obtainable combining a certain flow regulator (mm/sec) with a cylinder

Mod.	Cylinders diameter (mm)						
	32	40	50	63	80	100	125
GSCU-1/8"; GSVU-1/8"; GMCU-1/8"; GSCU-1/8"	1000	986	629	395	246	158	100
GSCU-1/4"; GSVU-1/4"; GMCU-1/4"; GSCU-1/4"	-	1000	911	573	357	229	145
RFU 452 M5	204	-	-	-	-	-	-
RFU 482-1/8"	227	145	93	58	36	-	-
RFU 483-1/8"	520	333	212	133	83	53	-
RFU 444-1/4"	-	739	471	296	185	118	75
RFU 446-1/4"	-	-	847	532	332	213	135
SCU M5 - SVU M5	154	-	-	-	-	-	-
SCU-1/4"; SVU-1/4"; MCU-1/4"; MVU-1/4"	-	1000	660	415	259	166	105
SCU-1/8"; SVU-1/8"; MCU-1/8"; MVU-1/8"	604	387	247	155	97	62	-
SCU-3/8"; MCU-3/8"	-	-	-	622	388	249	158
SCU-1/2"; MCU-1/2"	-	-	-	-	1000	869	-

To obtain the above indicated speeds, the connected tubing should have a certain diameter and not exceed, if indicated, the max length (m)

Mod.	Tube diameter (mm) and max length (m)				
	4/2	6/4	8/6	10/8	12/10
GSCU-1/8"; GSVU-1/8"; GMCU-1/8"; GSCU-1/8"	-	0,4	8	25	-
GSCU-1/4"; GSVU-1/4"; GMCU-1/4"; GSCU-1/4"	-	-	4,5	18	24
RFU 452 M5	3,5	25	-	-	-
RFU 482-1/8"	3	25	-	-	-
RFU 483-1/8"	0,25	10	-	-	-
RFU 444-1/4"	-	2	17	-	-
RFU 446-1/4"	-	-	5	20	-
SCU M5 - SVU M5	5	-	-	-	-
SCU-1/4"; SVU-1/4"; MCU-1/4"; MVU-1/4"	-	0,4	8	25	-
SCU-1/8"; SVU-1/8"; MCU-1/8"; MVU-1/8"	-	7	-	-	-
SCU-3/8"; MCU-3/8"	-	-	3,5	-	-
SCU-1/2"; MCU-1/2"	-	-	-	0,25	3,5

Air flow required by the valve (6 bar) to obtain the above indicated speeds (NI/min)

Mod.	Cylinders diameter (mm)						
	32	40	50	63	80	100	125
GSCU-1/8"; GSVU-1/8"; GMCU-1/8"; GSCU-1/8"	336	517	517	517	517	517	517
GSCU-1/4"; GSVU-1/4"; GMCU-1/4"; GSCU-1/4"	-	525	750	750	750	750	750
RFU 452 M5	69	-	-	-	-	-	-
RFU 482-1/8"	76	76	76	76	76	-	-
RFU 483-1/8"	175	175	175	175	175	175	-
RFU 444-1/4"	-	388	388	388	388	388	388
RFU 446-1/4"	-	-	697	697	697	697	697
SCU M5 - SVU M5	52	-	-	-	-	-	-
SCU-1/4"; SVU-1/4"; MCU-1/4"; MVU-1/4"	-	525	543	543	543	543	543
SCU-1/8"; SVU-1/8"; MCU-1/8"; MVU-1/8"	203	203	203	203	203	203	-
SCU-3/8"; MCU-3/8"	-	-	-	815	815	815	815
SCU-1/2"; MCU-1/2"	-	-	-	-	2100	2846	-

Output forces double-acting cylinders

Thrust side

Values in Newton

SERIES >		16	24	25	27	31	32	QP	QN	QCT	QCB	QCBF	QCTF	40	41	42	50	52	60	61	62	63	90	92	94	95	97
∅	Thrust side	Pressure																									
		MPa (bar)	MPa (bar)	MPa (bar)	MPa (bar)	MPa (bar)	MPa (bar)	MPa (bar)	MPa (bar)	MPa (bar)	MPa (bar)	MPa (bar)	MPa (bar)	MPa (bar)	MPa (bar)	MPa (bar)	MPa (bar)	MPa (bar)	MPa (bar)	MPa (bar)	MPa (bar)	MPa (bar)	MPa (bar)	MPa (bar)	MPa (bar)	MPa (bar)	MPa (bar)
mm	cm ²	0,10 (1)	0,20 (2)	0,30 (3)	0,40 (4)	0,50 (5)	0,60 (6)	0,70 (7)	0,80 (8)	0,90 (9)	1 (10)																
8	0,50	4,44	8,9	13,3	17,7	22,2	26,6	31,0	35,5	39,9	44,4																
10	0,79	6,93	13,9	20,8	27,7	34,7	41,6	48,5	55,4	62,4	69,3																
12	1,13	9,98	20,0	29,9	39,9	49,9	59,9	69,9	79,8	89,8	99,8																
16	2,01	17,74	35,5	53,2	71,0	88,7	106,5	124,2	141,9	159,7	177,4																
20	3,14	27,72	55,4	83,2	110,9	138,6	166,3	194,1	221,8	249,5	277,2																
25	4,91	43,32	86,6	130,0	173,3	216,6	259,9	303,2	346,5	389,9	433,2																
32	8,04	70,97	141,9	212,9	283,9	354,9	425,8	496,8	567,8	638,7	709,7																
40	12,56	110,89	221,8	332,7	443,6	554,5	665,4	776,2	887,1	998,0	1108,9																
50	19,63	173,27	346,5	519,8	693,1	866,3	1039,6	1212,9	1386,2	1559,4	1732,7																
63	31,16	275,08	550,2	825,2	1100,3	1375,4	1650,5	1925,6	2200,7	2475,7	2750,8																
80	50,24	443,57	887,1	1330,7	1774,3	2217,8	2661,4	3105,0	3548,6	3992,1	4435,7																
100	78,50	693,08	1386,2	2079,2	2772,3	3465,4	4158,5	4851,5	5544,6	6237,7	6930,8																
125	122,66	1082,93	2165,9	3248,8	4331,7	5414,7	6497,6	7580,5	8663,5	9746,4	10829,3																
160	200,96	1774,28	3548,6	5322,8	7097,1	8871,4	10645,7	12419,9	14194,2	15968,5	17742,8																
200	314,00	2772,31	5544,6	8316,9	11089,2	13861,5	16633,8	19406,1	22178,4	24950,8	27723,1																
250	490,62	4331,73	8663,5	12995,2	17326,9	21658,6	25990,4	30322,1	34653,8	38985,6	43317,3																
320	803,84	7097,10	14194,2	21291,3	28388,4	35485,5	42582,6	49679,7	56776,8	63873,9	70971,0																

SERIES > QX

SERIES >		16	24	25	27	31	32	QP	QN	QCT	QCB	QCBF	QCTF	40	41	42	50	52	60	61	62	63	90	92	94	95	97
∅	Thrust side	Pressure																									
		MPa (bar)	MPa (bar)	MPa (bar)	MPa (bar)	MPa (bar)	MPa (bar)	MPa (bar)	MPa (bar)	MPa (bar)	MPa (bar)	MPa (bar)	MPa (bar)	MPa (bar)	MPa (bar)	MPa (bar)	MPa (bar)	MPa (bar)	MPa (bar)	MPa (bar)	MPa (bar)	MPa (bar)	MPa (bar)	MPa (bar)	MPa (bar)	MPa (bar)	MPa (bar)
mm	cm ²	0,10 (1)	0,20 (2)	0,30 (3)	0,40 (4)	0,50 (5)	0,60 (6)	0,70 (7)	0,80 (8)	0,90 (9)	1 (10)																
10	1,58	14,22	28,44	42,66	56,88	71,1	85,32	99,54	113,76	127,98	142,2																
16	4,02	35,48	71	106,4	142	177,4	213	248,4	283,8	319,4	354,8																
20	6,28	55,44	110,8	166,4	221,8	277,2	332,6	388,2	443,6	499	554,4																
25	9,82	86,64	173,2	260	346,6	433,2	519,8	606,4	693	779,8	866,4																
32	16,08	141,94	283,8	425,8	567,8	709,8	851,6	993,6	1135,6	1277,4	1419,4																

Traction side

Values in Newton

SERIES >		16	24	25	40	41	42	60	61	62	63	90	92	94	95	97												
∅	Thrust side	∅ rod	Traction side	Pressure																								
				MPa (bar)	MPa (bar)	MPa (bar)	MPa (bar)	MPa (bar)	MPa (bar)	MPa (bar)	MPa (bar)	MPa (bar)	MPa (bar)	MPa (bar)	MPa (bar)	MPa (bar)	MPa (bar)	MPa (bar)	MPa (bar)	MPa (bar)	MPa (bar)	MPa (bar)	MPa (bar)	MPa (bar)	MPa (bar)	MPa (bar)	MPa (bar)	MPa (bar)
mm	cm ²	mm	cm ²	0,10 (1)	0,20 (2)	0,30 (3)	0,40 (4)	0,50 (5)	0,60 (6)	0,70 (7)	0,80 (8)	0,90 (9)	1 (10)															
8	0,50	4	0,38	3,33	6,7	10,0	13,3	16,6	20,0	23,3	26,6	29,9	33,3															
10	0,79	4	0,66	5,82	11,6	17,5	23,3	29,1	34,9	40,8	46,6	52,4	58,2															
12	1,13	6	0,85	7,49	15,0	22,5	29,9	37,4	44,9	52,4	59,9	67,4	74,9															
16	2,01	6	1,73	15,25	30,5	45,7	61,0	76,2	91,5	106,7	122,0	137,2	152,5															
20	3,14	8	2,64	23,29	46,6	69,9	93,1	116,4	139,7	163,0	186,3	209,6	232,9															
25	4,91	10	4,12	36,39	72,8	109,2	145,5	181,9	218,3	254,7	291,1	327,5	363,9															
32	8,04	12	6,91	60,99	122,0	183,0	244,0	305,0	365,9	426,9	487,9	548,9	609,9															
40	12,56	16	10,55	93,15	186,3	279,4	372,6	465,7	558,9	652,0	745,2	838,3	931,5															
50	19,63	20	16,49	145,55	291,1	436,6	582,2	727,7	873,3	1018,8	1164,4	1309,9	1455,5															
63	31,16	20	28,02	247,36	494,7	742,1	989,4	1236,8	1484,2	1731,5	1978,9	2226,2	2473,6															
80	50,24	25	45,33	400,25	800,5	1200,8	1601,0	2001,3	2401,5	2801,8	3202,0	3602,3	4002,5															
100	78,50	25	73,59	649,76	1299,5	1949,3	2599,0	3248,8	3898,6	4548,3	5198,1	5847,8	6497,6															
125	122,66	32	114,62	1011,96	2023,9	3035,9	4047,8	5059,8	6071,8	7083,7	8095,7	9107,6	10119,6															
160	200,96	40	188,40	1663,38	3326,8	4990,2	6653,5	8316,9	9980,3	11643,7	13307,1	14970,5	16633,8															
200	314,00	40	301,44	2661,41	5322,8	7984,2	10645,7	13307,1	15968,5	18629,9	21291,3	23952,7	26614,1															
250	490,62	50	471,00	4158,46	8316,9	12475,4	16633,8	20792,3	24950,8	29109,2	33267,7	37426,1	41584,6															
320	803,84	63	772,68	6822,02	13644,0	20466,1	27288,1	34110,1	40932,1	47754,1	54576,2	61398,2	68220,2															

SERIES > QX

SERIES >		16	24	25	40	41	42	60	61	62	63	90	92	94	95	97												
∅	Thrust side	∅ rod	Traction side	Pressure																								
				MPa (bar)	MPa (bar)	MPa (bar)	MPa (bar)	MPa (bar)	MPa (bar)	MPa (bar)	MPa (bar)	MPa (bar)	MPa (bar)	MPa (bar)	MPa (bar)	MPa (bar)	MPa (bar)	MPa (bar)	MPa (bar)	MPa (bar)	MPa (bar)	MPa (bar)	MPa (bar)	MPa (bar)	MPa (bar)	MPa (bar)		
mm	cm ²	mm	cm ²	0,10 (1)	0,20 (2)	0,30 (3)	0,40 (4)	0,50 (5)	0,60 (6)	0,70 (7)	0,80 (8)	0,90 (9)	1 (10)															
10	1,58	6	1,0148	9,1332	18,2664	27,3996	36,5328	45,666	54,7992	63,9324	73,0656	82,1988	91,332															
16	4,02	16	3,02	26,62	53,2	79,8	106,4	133	159,6	186,2	213	239,6	266,2															
20	6,28	20	4,72	41,58	83,2	124,8	166,4	208	249,6	291	332,6	374,2	415,8															
25	9,82	24	7,56	66,68	133,4	200	266,6	333,4	400	466,8	533,4	600	666,8															
32	16,08	32	12,06	106,46	213	319,4	425,8	532,2	638,8	745,2	851,6	958,2	1064,6															

Traction side

Values in Newton

SERIES > 31 32													
Ø	Thrust side	Ø rod	Traction side	Pressure									
				MPa (bar)	MPa (bar)	MPa (bar)	MPa (bar)	MPa (bar)	MPa (bar)	MPa (bar)	MPa (bar)	MPa (bar)	MPa (bar)
mm	cm ²	mm	cm ²	0,10 (1)	0,20 (2)	0,30 (3)	0,40 (4)	0,50 (5)	0,60 (6)	0,70 (7)	0,80 (8)	0,90 (9)	1 (10)
12	1,13	6	0,85	7,49	15,0	22,5	29,9	37,4	44,9	52,4	59,9	67,4	74,9
16	2,01	8	1,51	13,31	26,6	39,9	53,2	66,5	79,8	93,1	106,5	119,8	133,1
20	3,14	10	2,36	20,79	41,6	62,4	83,2	104,0	124,8	145,5	166,3	187,1	207,9
25	4,91	10	4,12	36,39	72,8	109,2	145,5	181,9	218,3	254,7	291,1	327,5	363,9
32	8,04	12	6,91	60,99	122,0	183,0	244,0	305,0	365,9	426,9	487,9	548,9	609,9
40	12,56	12	11,43	100,91	201,8	302,7	403,6	504,6	605,5	706,4	807,3	908,2	1009,1
50	19,63	16	17,62	155,53	311,1	466,6	622,1	777,6	933,2	1088,7	1244,2	1399,7	1555,3
63	31,16	16	29,15	257,34	514,7	772,0	1029,4	1286,7	1544,0	1801,4	2058,7	2316,1	2573,4
80	50,24	20	47,10	415,85	831,7	1247,5	1663,4	2079,2	2495,1	2910,9	3326,8	3742,6	4158,5
100	78,50	25	73,59	649,76	1299,5	1949,3	2599,0	3248,8	3898,6	4548,3	5198,1	5847,8	6497,6

SERIES > QP													
Ø	Thrust side	Ø rod	Traction side	Pressure									
				MPa (bar)	MPa (bar)	MPa (bar)	MPa (bar)	MPa (bar)	MPa (bar)	MPa (bar)	MPa (bar)	MPa (bar)	MPa (bar)
mm	cm ²	mm	cm ²	0,10 (1)	0,20 (2)	0,30 (3)	0,40 (4)	0,50 (5)	0,60 (6)	0,70 (7)	0,80 (8)	0,90 (9)	1 (10)
12	1,13	6	0,85	7,49	15,0	22,5	29,9	37,4	44,9	52,4	59,9	67,4	74,9
16	2,01	8	1,51	13,31	26,6	39,9	53,2	66,5	79,8	93,1	106,5	119,8	133,1
20	3,14	10	2,36	20,79	41,6	62,4	83,2	104,0	124,8	145,5	166,3	187,1	207,9
25	4,91	10	4,12	36,39	72,8	109,2	145,5	181,9	218,3	254,7	291,1	327,5	363,9
32	8,04	12	6,91	60,99	122,0	183,0	244,0	305,0	365,9	426,9	487,9	548,9	609,9
40	12,56	16	10,55	93,15	186,3	279,4	372,6	465,7	558,9	652,0	745,2	838,3	931,5
50	19,63	16	17,62	155,53	311,1	466,6	622,1	777,6	933,2	1088,7	1244,2	1399,7	1555,3
63	31,16	20	28,02	247,36	494,7	742,1	989,4	1236,8	1484,2	1731,5	1978,9	2226,2	2473,6
80	50,24	25	45,33	400,25	800,5	1200,8	1601,0	2001,3	2401,5	2801,8	3202,0	3602,3	4002,5
100	78,50	25	73,59	649,76	1299,5	1949,3	2599,0	3248,8	3898,6	4548,3	5198,1	5847,8	6497,6

SERIES > 27													
Ø	Thrust side	Ø rod	Traction side	Pressure									
				MPa (bar)	MPa (bar)	MPa (bar)	MPa (bar)	MPa (bar)	MPa (bar)	MPa (bar)	MPa (bar)	MPa (bar)	MPa (bar)
mm	cm ²	mm	cm ²	0,10 (1)	0,20 (2)	0,30 (3)	0,40 (4)	0,50 (5)	0,60 (6)	0,70 (7)	0,80 (8)	0,90 (9)	1 (10)
20	3,14	8	2,64	23,29	46,6	69,9	93,1	116,4	139,7	163,0	186,3	209,6	232,9
25	4,91	10	4,12	36,39	72,8	109,2	145,5	181,9	218,3	254,7	291,1	327,5	363,9
32	8,04	12	6,91	60,99	122,0	183,0	244,0	305,0	365,9	426,9	487,9	548,9	609,9
40	12,56	16	10,55	93,15	186,3	279,4	372,6	465,7	558,9	652,0	745,2	838,3	931,5
50	19,63	16	17,62	155,53	311,1	466,6	622,1	777,6	933,2	1088,7	1244,2	1399,7	1555,3
63	31,16	20	28,02	247,36	494,7	742,1	989,4	1236,8	1484,2	1731,5	1978,9	2226,2	2473,6

SERIES > QCT QCB QCTF QCBF													
Ø	Thrust side	Ø rod	Traction side	Pressure									
				MPa (bar)	MPa (bar)	MPa (bar)	MPa (bar)	MPa (bar)	MPa (bar)	MPa (bar)	MPa (bar)	MPa (bar)	MPa (bar)
mm	cm ²	mm	cm ²	0,10 (1)	0,20 (2)	0,30 (3)	0,40 (4)	0,50 (5)	0,60 (6)	0,70 (7)	0,80 (8)	0,90 (9)	1 (10)
20	3,14	10	2,36	20,79	41,6	62,4	83,2	104,0	124,8	145,5	166,3	187,1	207,9
25	4,91	12	3,78	33,34	66,7	100,0	133,3	166,7	200,0	233,4	266,7	300,0	333,4
32	8,04	16	6,03	53,23	106,5	159,7	212,9	266,1	319,4	372,6	425,8	479,1	532,3
40	12,56	16	10,55	93,15	186,3	279,4	372,6	465,7	558,9	652,0	745,2	838,3	931,5
50	19,63	20	16,49	145,55	291,1	436,6	582,2	727,7	873,3	1018,8	1164,4	1309,9	1455,5
63	31,16	20	28,02	247,36	494,7	742,1	989,4	1236,8	1484,2	1731,5	1978,9	2226,2	2473,6

Table showing air consumption of double-acting cylinders

Thrust side

Values in NI for each 10 mm of stroke

SERIES >		16	24	25	27	31	32	QP	QCT	QCB	QCBF	QCTF	40	41	42	50	52	60	61	62	63	90	92	94	95	97	
∅	Thrust side	Pressure																									
		MPa (bar)	MPa (bar)	MPa (bar)	MPa (bar)	MPa (bar)	MPa (bar)	MPa (bar)	MPa (bar)	MPa (bar)	MPa (bar)	MPa (bar)	MPa (bar)	MPa (bar)	MPa (bar)	MPa (bar)	MPa (bar)	MPa (bar)	MPa (bar)	MPa (bar)	MPa (bar)	MPa (bar)	MPa (bar)	MPa (bar)	MPa (bar)	MPa (bar)	MPa (bar)
mm	cm ²	0,10 (1)	0,20 (2)	0,30 (3)	0,40 (4)	0,50 (5)	0,60 (6)	0,70 (7)	0,80 (8)	0,90 (9)	1 (10)																
8	0,50	0,001	0,002	0,002	0,003	0,003	0,004	0,005	0,006	0,007	0,008	0,009	0,010	0,011	0,012	0,014	0,016	0,018	0,020	0,022	0,025	0,028	0,031	0,034	0,037	0,040	0,043
10	0,79	0,002	0,002	0,003	0,004	0,005	0,006	0,007	0,008	0,009	0,010	0,011	0,012	0,013	0,014	0,016	0,018	0,020	0,022	0,025	0,028	0,031	0,034	0,037	0,040	0,043	0,046
12	1,13	0,002	0,003	0,005	0,006	0,007	0,008	0,009	0,010	0,011	0,012	0,013	0,014	0,015	0,016	0,018	0,020	0,022	0,025	0,028	0,031	0,034	0,037	0,040	0,043	0,046	0,049
16	2,01	0,004	0,006	0,008	0,010	0,012	0,014	0,016	0,018	0,020	0,022	0,025	0,028	0,031	0,034	0,037	0,040	0,043	0,046	0,049	0,052	0,055	0,058	0,061	0,064	0,067	0,070
20	3,14	0,006	0,009	0,013	0,016	0,019	0,022	0,025	0,028	0,031	0,034	0,037	0,040	0,043	0,046	0,049	0,052	0,055	0,058	0,061	0,064	0,067	0,070	0,073	0,076	0,079	0,082
25	4,91	0,010	0,015	0,020	0,025	0,029	0,034	0,039	0,044	0,049	0,054	0,059	0,064	0,069	0,074	0,079	0,084	0,089	0,094	0,099	0,104	0,109	0,114	0,119	0,124	0,129	0,134
32	8,04	0,016	0,024	0,032	0,040	0,048	0,056	0,064	0,072	0,080	0,088	0,096	0,104	0,112	0,120	0,128	0,136	0,144	0,152	0,160	0,168	0,176	0,184	0,192	0,200	0,208	0,216
40	12,56	0,025	0,038	0,050	0,063	0,075	0,088	0,100	0,113	0,126	0,138	0,151	0,164	0,177	0,190	0,203	0,216	0,229	0,242	0,255	0,268	0,281	0,294	0,307	0,320	0,333	0,346
50	19,63	0,039	0,059	0,079	0,098	0,118	0,137	0,157	0,177	0,196	0,216	0,235	0,255	0,274	0,294	0,313	0,333	0,352	0,372	0,391	0,411	0,430	0,450	0,469	0,489	0,508	0,527
63	31,16	0,062	0,093	0,125	0,156	0,187	0,218	0,249	0,280	0,312	0,343	0,374	0,405	0,436	0,467	0,498	0,529	0,560	0,591	0,622	0,653	0,684	0,715	0,746	0,777	0,808	0,839
80	50,24	0,100	0,151	0,201	0,251	0,301	0,352	0,402	0,452	0,502	0,553	0,603	0,653	0,703	0,753	0,803	0,853	0,903	0,953	1,003	1,053	1,103	1,153	1,203	1,253	1,303	1,353
100	78,50	0,157	0,236	0,314	0,393	0,471	0,550	0,628	0,707	0,785	0,864	0,942	1,021	1,100	1,179	1,258	1,337	1,416	1,495	1,574	1,653	1,732	1,811	1,890	1,969	2,048	2,127
125	122,66	0,245	0,368	0,491	0,613	0,736	0,859	0,981	1,104	1,227	1,349	1,472	1,595	1,718	1,841	1,964	2,087	2,210	2,333	2,456	2,579	2,702	2,825	2,948	3,071	3,194	3,317
160	200,96	0,402	0,603	0,804	1,005	1,206	1,407	1,608	1,809	2,010	2,211	2,412	2,613	2,814	3,015	3,216	3,417	3,618	3,819	4,020	4,221	4,422	4,623	4,824	5,025	5,226	5,427
200	314,00	0,628	0,942	1,256	1,570	1,884	2,198	2,512	2,826	3,140	3,454	3,768	4,082	4,396	4,710	5,024	5,338	5,652	5,966	6,280	6,594	6,908	7,222	7,536	7,850	8,164	8,478
250	490,63	0,981	1,472	1,963	2,453	2,944	3,434	3,925	4,416	4,906	5,397	5,887	6,378	6,868	7,359	7,849	8,340	8,830	9,321	9,811	10,302	10,792	11,283	11,773	12,264	12,754	13,245
320	803,84	1,608	2,412	3,215	4,019	4,823	5,627	6,431	7,235	8,038	8,842	9,646	10,450	11,254	12,058	12,862	13,666	14,470	15,274	16,078	16,882	17,686	18,490	19,294	20,098	20,902	21,706

SERIES >		QX										
∅	Thrust side	Pressure										
		MPa (bar)	MPa (bar)	MPa (bar)	MPa (bar)	MPa (bar)	MPa (bar)	MPa (bar)	MPa (bar)	MPa (bar)	MPa (bar)	MPa (bar)
mm	cm ²	0,10 (1)	0,20 (2)	0,30 (3)	0,40 (4)	0,50 (5)	0,60 (6)	0,70 (7)	0,80 (8)	0,90 (9)	1 (10)	
10	1,58	0,003	0,005	0,006	0,008	0,009	0,011	0,013	0,014	0,016	0,017	
16	4,02	0,008	0,012	0,016	0,02	0,024	0,028	0,032	0,036	0,04	0,044	
20	6,28	0,012	0,018	0,026	0,032	0,038	0,044	0,05	0,056	0,062	0,07	
25	9,82	0,02	0,03	0,04	0,05	0,058	0,068	0,078	0,088	0,098	0,108	
32	16,08	0,032	0,048	0,064	0,08	0,096	0,112	0,128	0,144	0,16	0,176	

Traction side

Values in NI for each 10 mm of stroke

SERIES >		16	24	25	40	41	42	60	61	62	63	90	92	94	95	97
∅	Thrust side	∅ rod	Traction side	Pressure												
				MPa (bar)	MPa (bar)	MPa (bar)	MPa (bar)	MPa (bar)	MPa (bar)	MPa (bar)	MPa (bar)	MPa (bar)	MPa (bar)	MPa (bar)	MPa (bar)	MPa (bar)
mm	cm ²	mm	cm ²	0,10 (1)	0,20 (2)	0,30 (3)	0,40 (4)	0,50 (5)	0,60 (6)	0,70 (7)	0,80 (8)	0,90 (9)	1 (10)			
8	0,50	4	0,38	0,001	0,001	0,002	0,002	0,002	0,003	0,003	0,003	0,004	0,004			
10	0,79	4	0,66	0,001	0,002	0,003	0,003	0,004	0,005	0,005	0,006	0,007	0,007			
12	1,13	6	0,85	0,002	0,003	0,003	0,004	0,005	0,006	0,007	0,008	0,008	0,009			
16	2,01	6	1,73	0,003	0,005	0,007	0,009	0,010	0,012	0,014	0,016	0,017	0,019			
20	3,14	8	2,64	0,005	0,008	0,011	0,013	0,016	0,018	0,021	0,024	0,026	0,029			
25	4,91	10	4,12	0,008	0,012	0,016	0,021	0,025	0,029	0,033	0,037	0,041	0,045			
32	8,04	12	6,91	0,014	0,021	0,028	0,035	0,041	0,048	0,055	0,062	0,069	0,076			
40	12,56	16	10,55	0,021	0,032	0,042	0,053	0,063	0,074	0,084	0,095	0,106	0,116			
50	19,63	20	16,49	0,033	0,049	0,066	0,082	0,099	0,115	0,132	0,148	0,165	0,181			
63	31,16	20	28,02	0,056	0,084	0,112	0,140	0,168	0,196	0,224	0,252	0,280	0,308			
80	50,24	25	45,33	0,091	0,136	0,181	0,227	0,272	0,317	0,363	0,408	0,453	0,499			
100	78,50	25	73,59	0,147	0,221	0,294	0,368	0,442	0,515	0,589	0,662	0,736	0,810			
125	122,66	32	114,62	0,229	0,344	0,458	0,573	0,688	0,802	0,917	1,032	1,146	1,261			
160	200,96	40	188,40	0,377	0,565	0,754	0,942	1,130	1,319	1,507	1,696	1,884	2,072			
200	314,00	40	301,44	0,603	0,904	1,206	1,507	1,809	2,110	2,412	2,713	3,014	3,316			
250	490,63	50	471,00	0,942	1,413	1,884	2,355	2,826	3,297	3,768	4,239	4,710	5,181			
320	803,84	63	772,68	1,545	2,318	3,091	3,863	4,636	5,409	6,181	6,954	7,727	8,500			

SERIES >		QX											
∅	Thrust side	∅ rod	Traction side	Pressure									
				MPa (bar)	MPa (bar)	MPa (bar)	MPa (bar)	MPa (bar)	MPa (bar)	MPa (bar)	MPa (bar)	MPa (bar)	MPa (bar)
mm	cm ²	mm	cm ²	0,10 (1)	0,20 (2)	0,30 (3)	0,40 (4)	0,50 (5)	0,60 (6)	0,70 (7)	0,80 (8)	0,90 (9)	1 (10)
10	1,58	6	1,0148	0,002	0,003	0,004	0,005	0,006	0,007	0,008	0,009	0,010	0,011
16	4,02	16	3,02	0,006	0,01	0,012	0,016	0,018	0,022	0,024	0,028	0,03	0,034
20	6,28	20	4,72	0,01	0,014	0,018	0,024	0,028	0,032	0,038	0,042	0,048	0,052
25	9,82	24	7,56	0,016	0,022	0,03	0,038	0,046	0,052	0,06	0,068	0,076	0,084
32	16,08	32	12,06	0,024	0,036	0,048	0,06	0,072	0,084	0,096	0,108	0,12	0,132

Traction side

Values in NI for each 10 mm of stroke

SERIES > 31 32													
∅	Thrust side	∅ rod	Traction side	Pressure									
				MPa (bar)	MPa (bar)	MPa (bar)	MPa (bar)	MPa (bar)	MPa (bar)	MPa (bar)	MPa (bar)	MPa (bar)	MPa (bar)
mm	cm ²	mm	cm ²	0,10 (1)	0,20 (2)	0,30 (3)	0,40 (4)	0,50 (5)	0,60 (6)	0,70 (7)	0,80 (8)	0,90 (9)	1 (10)
12	1,13	6	0,85	0,002	0,003	0,003	0,004	0,005	0,006	0,007	0,008	0,008	0,009
16	2,01	8	1,51	0,003	0,005	0,006	0,008	0,009	0,011	0,012	0,014	0,015	0,017
20	3,14	10	2,36	0,005	0,007	0,009	0,012	0,014	0,016	0,019	0,021	0,024	0,026
25	4,91	10	4,12	0,008	0,012	0,016	0,021	0,025	0,029	0,033	0,037	0,041	0,045
32	8,04	12	6,91	0,014	0,021	0,028	0,035	0,041	0,048	0,055	0,062	0,069	0,076
40	12,56	12	11,43	0,023	0,034	0,046	0,057	0,069	0,080	0,091	0,103	0,114	0,126
50	19,63	16	17,62	0,035	0,053	0,070	0,088	0,106	0,123	0,141	0,159	0,176	0,194
63	31,16	16	29,15	0,058	0,087	0,117	0,146	0,175	0,204	0,233	0,262	0,291	0,321
80	50,24	20	47,10	0,094	0,141	0,188	0,236	0,283	0,330	0,377	0,424	0,471	0,518
100	78,50	25	73,59	0,147	0,221	0,294	0,368	0,442	0,515	0,589	0,662	0,736	0,810

SERIES > QP													
∅	Thrust side	∅ rod	Traction side	Pressure									
				MPa (bar)	MPa (bar)	MPa (bar)	MPa (bar)	MPa (bar)	MPa (bar)	MPa (bar)	MPa (bar)	MPa (bar)	MPa (bar)
mm	cm ²	mm	cm ²	0,10 (1)	0,20 (2)	0,30 (3)	0,40 (4)	0,50 (5)	0,60 (6)	0,70 (7)	0,80 (8)	0,90 (9)	1 (10)
12	1,13	6	0,85	0,002	0,003	0,003	0,004	0,005	0,006	0,007	0,008	0,008	0,009
16	2,01	8	1,51	0,003	0,005	0,006	0,008	0,009	0,011	0,012	0,014	0,015	0,017
20	3,14	10	2,36	0,005	0,007	0,009	0,012	0,014	0,016	0,019	0,021	0,024	0,026
25	4,91	10	4,12	0,008	0,012	0,016	0,021	0,025	0,029	0,033	0,037	0,041	0,045
32	8,04	12	6,91	0,014	0,021	0,028	0,035	0,041	0,048	0,055	0,062	0,069	0,076
40	12,56	16	10,55	0,021	0,032	0,042	0,053	0,063	0,074	0,084	0,095	0,106	0,116
50	19,63	16	17,62	0,035	0,053	0,070	0,088	0,106	0,123	0,141	0,159	0,176	0,194
63	31,16	20	28,02	0,056	0,084	0,112	0,140	0,168	0,196	0,224	0,252	0,280	0,308
80	50,24	25	45,33	0,091	0,136	0,181	0,227	0,272	0,317	0,363	0,408	0,453	0,499
100	78,50	25	73,59	0,147	0,221	0,294	0,368	0,442	0,515	0,589	0,662	0,736	0,810

SERIES > 27													
∅	Thrust side	∅ rod	Traction side	Pressure									
				MPa (bar)	MPa (bar)	MPa (bar)	MPa (bar)	MPa (bar)	MPa (bar)	MPa (bar)	MPa (bar)	MPa (bar)	MPa (bar)
mm	cm ²	mm	cm ²	0,10 (1)	0,20 (2)	0,30 (3)	0,40 (4)	0,50 (5)	0,60 (6)	0,70 (7)	0,80 (8)	0,90 (9)	1 (10)
20	3,14	8	2,64	0,005	0,008	0,011	0,013	0,016	0,018	0,021	0,024	0,026	0,029
25	4,91	10	4,12	0,008	0,012	0,016	0,021	0,025	0,029	0,033	0,037	0,041	0,045
32	8,04	12	6,91	0,014	0,021	0,028	0,035	0,041	0,048	0,055	0,062	0,069	0,076
40	12,56	16	10,55	0,021	0,032	0,042	0,053	0,063	0,074	0,084	0,095	0,106	0,116
50	19,63	16	17,62	0,035	0,053	0,070	0,088	0,106	0,123	0,141	0,159	0,176	0,194
63	31,16	20	28,02	0,056	0,084	0,112	0,140	0,168	0,196	0,224	0,252	0,280	0,308

SERIES > QCT QCB QCTF QCBF													
∅	Thrust side	∅ rod	Traction side	Pressure									
				MPa (bar)	MPa (bar)	MPa (bar)	MPa (bar)	MPa (bar)	MPa (bar)	MPa (bar)	MPa (bar)	MPa (bar)	MPa (bar)
mm	cm ²	mm	cm ²	0,10 (1)	0,20 (2)	0,30 (3)	0,40 (4)	0,50 (5)	0,60 (6)	0,70 (7)	0,80 (8)	0,90 (9)	1 (10)
20	3,14	10	2,36	0,005	0,007	0,009	0,012	0,014	0,016	0,019	0,021	0,024	0,026
25	4,91	12	3,78	0,008	0,011	0,015	0,019	0,023	0,026	0,030	0,034	0,038	0,042
32	8,04	16	6,03	0,012	0,018	0,024	0,030	0,036	0,042	0,048	0,054	0,060	0,066
40	12,56	16	10,55	0,021	0,032	0,042	0,053	0,063	0,074	0,084	0,095	0,106	0,116
50	19,63	20	16,49	0,033	0,049	0,066	0,082	0,099	0,115	0,132	0,148	0,165	0,181
63	31,16	20	28,02	0,056	0,084	0,112	0,140	0,168	0,196	0,224	0,252	0,280	0,308

SERIES > ARP													
Mod.	Volume (l)		Pressure (opening/closing)										
	open./clos.		MPa (bar)	MPa (bar)	MPa (bar)	MPa (bar)	MPa (bar)	MPa (bar)	MPa (bar)	MPa (bar)	MPa (bar)	MPa (bar)	MPa (bar)
			0,10 (1)	0,20 (2)	0,30 (3)	0,40 (4)	0,50 (5)	0,60 (6)	0,70 (7)	0,80 (8)	0,90 (9)	1 (10)	
ARP 001	0,03	0,03	0,05/0,05	0,08/0,08	0,11/0,11	0,13/0,13	0,16/0,16	0,19/0,19	0,21/0,21	0,24/0,24	0,27/0,27	0,29/0,29	
ARP 003	0,10	0,10	0,20/0,20	0,30/0,30	0,40/0,40	0,50/0,50	0,60/0,60	0,70/0,70	0,80/0,80	0,90/0,90	1,00/1,00	1,10/1,10	
ARP 005	0,20	0,30	0,40/0,60	0,60/0,90	0,80/1,20	1,00/1,50	1,20/1,80	1,40/2,10	1,60/2,40	1,80/2,70	2,00/3,00	2,20/3,30	
ARP 010	0,40	0,50	0,80/1,00	1,20/1,50	1,60/2,00	2,00/2,50	2,40/3,00	2,80/3,50	3,20/4,00	3,60/4,50	4,00/5,00	4,40/5,50	
ARP 012	0,49	0,64	0,98/1,28	1,47/1,92	1,96/2,56	2,45/3,20	2,94/3,84	3,43/4,48	3,92/5,12	4,41/5,76	4,90/6,40	5,39/7,04	
ARP 020	0,90	1,00	1,80/2,00	2,70/3,00	3,60/4,00	4,50/5,00	5,40/6,00	6,30/7,00	7,20/8,00	8,10/9,00	9,00/10,00	9,90/11,00	
ARP 035	1,69	1,90	3,38/3,80	5,07/5,70	6,76/7,60	8,45/9,50	10,14/11,40	11,83/13,30	13,52/15,20	15,21/17,10	16,90/19,00	18,59/20,90	
ARP 055	2,80	3,40	5,60/6,80	8,40/10,20	11,20/13,60	14,00/17,00	16,80/20,40	19,60/23,80	22,40/27,20	25,20/30,60	28,00/34,00	30,80/37,40	
ARP 055	2,80	3,40	5,60/6,80	8,40/10,20	11,20/13,60	14,00/17,00	16,80/20,40	19,60/23,80	22,40/27,20	25,20/30,60	28,00/34,00	30,80/37,40	
ARP 070	3,05	3,70	6,10/7,40	9,15/11,10	12,20/14,80	15,25/18,50	18,30/22,20	21,35/25,90	24,40/29,60	27,45/33,30	30,50/37,00	33,55/40,70	
ARP 100	5,52	5,90	11,04/11,80	16,56/17,70	22,08/23,60	27,60/29,50	33,12/35,40	38,64/41,30	44,16/47,20	49,68/53,10	55,20/59,00	60,72/64,90	
ARP 150	7,60	9,60	15,20/19,20	22,80/28,80	30,40/38,40	38,00/48,00	45,60/57,60	53,20/67,20	60,80/76,80	68,40/86,40	76,00/96,00	83,60/105,60	
ARP 250	8,50	9,80	17,00/19,60	25,50/29,40	34,00/39,20	42,50/49,00	51,00/58,80	59,50/68,60	68,00/78,40	76,50/88,20	85,00/98,00	93,50/107,80	
ARP 400	13,60	17,50	27,20/35,00	40,80/52,50	54,40/70,00	68,00/87,50	81,60/105,00	95,20/122,50	108,80/140,00	122,40/157,50	136,00/175,00	149,60/192,50	

See full catalogue or catalogue.camozzi.com for all dimensions.
For technical advice contact our sales office or your local Camozzi distributor.

Quality: our priority commitment

Research, technological innovation, training, respect for personnel, employee and environmental safety and total customer care are all factors that Camozzi considers strategic in the achievement of quality.

To Camozzi quality is a system that ensures excellence, not only of the final product but throughout the entire business process.



Our certifications

Camozzi's main goals include quality and safety, the protection of the environment and compatibility of our activities with the territories in which they are performed.

Since 1993 Camozzi has been certified in accordance with the ISO 9001 standard for quality management. In 2003 the company obtained ISO 14001 certification for environmental management.

In the same year, DNV, the global quality assurance and risk management company, certified Camozzi's Integrated Management System, which includes both ISO 9001 and ISO 14001 standards. Furthermore, in 2013 Camozzi obtained ISO/TS 16949 certification for the Series C-Truck and Series 9000 fuel fittings, then transitioned to the new edition of the IATF 16949 standard in 2018.

From 1 July 2003, all products sold in the European Union and destined to be used in potentially explosive areas, had to be approved according to directive 94/9/CE, also known as ATEX.

This directive covered both electrical and non-electrical parts, including for instance pneumatic power and control equipment.

Mandatory directives

- Directive 99/34/EC concerning liability for defective products modified by Legislative Decree 02/02/01 n° 25.
- Directive 2014/35/EU "Equipment designed for use within certain voltages".
- Directive 2014/30/EU "Electromagnetic Compatibility EMC" and relative additions.
- Directive 2014/34/EU "Atex".
- Directive 2006/42/EC "Machinery".
- Directive 2014/68/EU "Pressure Equipment Directive".
- Directive 2001/95/EC "General product safety".
- Regulation 1907/2006 concerning the Registration, Evaluation, Authorisation and Restriction of Chemicals (REACH).

Technical standards

- ISO 4414 - Pneumatic fluid power - General rules and safety requirements for systems and their components

Environmental notes

- Packaging: we respect the environment, so use materials which can be recycled, including recyclable PE and paper.
- Green Design Project: in the study of new products, the environmental impact is always taken into consideration (real project, elaboration, etc.).

Information for the use of Camozzi products

In order to ensure proper functioning of Camozzi products these general guidelines should be noted.

Air quality

While resources such as electricity, water and gas are normally supplied by external companies to guaranteed standards, compressed air is produced from the ambient atmosphere. It is therefore the user that has to guarantee compressed air quality.

High quality air is essential for proper functioning of pneumatic systems. One cubic metre of air at atmospheric pressure typically contains the following:

- more than 150 million solid particles with dimensions from 0,01 μm to 100 μm ,
- fumes due to combustion,
- water vapour, with volume depending on temperature; at 30° there are about 30 g/m³ of water
- oil, up to about 0,03 mg
- micro organisms
- plus a variety of chemical contaminants, odours etc ...

The further the air is compressed, the higher the air quantity in the same volume and therefore the higher the amount of contaminants.

In order to reduce unwanted contents, compressors are fitted with filters, driers and oil separators at the inlet and outlet.

In spite of these precautions, the air, during its passage along pipes and tubes or while in storage tanks, can collect contaminants such as flakes of rust. Further, water vapour contained in the air can cool down and liquefy, then absorb and retain oil fumes.

For this reason it is advisable to fit compressed air systems and pneumatic machinery with air treatment equipment.

Air treatment: classification according to ISO 8573-1-2010 standard

ISO 8573-1-2010 Class	Solid particles			Max Concentration mg/m ³	Water		Oil Total content (liquid, aerosol and vapour) mg/m ³	
	Max. Number of Particles per m ³ 0,1 - 0,5 μm	0,5 - 1 μm	1 - 5 μm		Water pressure dew point °C	Liquid g/m ³		
0	More strict than class 1, defined by the device user							
1	≤ 20,000	≤ 400	≤ 10	-	≤ - 70°	-	≤ 0,01	
2	≤ 400,000	≤ 6,000	≤ 100	-	≤ - 40°	-	≤ 0,1	
3	-	≤ 90,000	≤ 1,000	-	≤ - 20°	-	≤ 1	
4	-	-	≤ 10,000	-	≤ + 3°	-	≤ 5	
5	-	-	≤ 100,000	-	≤ + 7°	-	-	
6	-	-	-	≤ 5	≤ + 10°	-	-	
7	-	-	-	5 - 10	-	≤ 0,5	-	
8	-	-	-	-	-	0,5 - 5	-	
9	-	-	-	-	-	5 - 10	-	
X	-	-	-	> 10	-	> 10	-	

Different types of air treatment equipment have different functions: isolation valves, pressure regulators, soft-start valves and of course filters. In some applications lubricators are still used, but this is increasingly unusual. Regarding filtering, there are international standards, such as ISO 8573-1-2010, that classify air according to its quality.

ISO 8573-1-2010 classifies compressed air according to the presence of three contaminating categories: solid particles, water or water vapour, and concentration of micro mist or oil vapours. In general, if not specified otherwise in the characteristics of the single component, Camozzi products require an ISO 8573-1-2010 class 7-4-4 air quality.

- **class 7** = air has a maximum concentration of SOLID PARTICLES of 5 mg/m³. The filtering elements are designed to separate solid particles with a dimension of more than 25 μm .

The air exiting from our filters and therefore the air at the inlet of all other components can contain solid particles with a maximum concentration of 5 mg/m³ and with a maximum dimension of 25 μm .

- **class 4** = the compressed AIR temperature has to be ≤ 3°C in order for entrained water vapour to condense and become liquid.

Conventional filters have characteristics that separate the humidity in the air only if it is in a liquid or near-liquid state.

It is the cooling of the air that enables condensation and removal of water vapour.

The air flow entering the bowl of the filter sustains a minimum expansion phase, (according to the Gas Law when gas suddenly expands, its temperature drops) followed by a vortex, this enables the heavier particles and the water vapour (condensing due to the expansion) to adhere to the sides of the bowl and slide down towards the drain.

Except for specific versions, users of Camozzi filters have to install driers in their compressed air production systems that, by cooling the air, dehumidify it.

- **class 4** = the concentration of OIL PARTICLES must be of maximum 5 mg/m³. It should be noted that compressors use oil for lubrication and that this can be carried into the compressed air system in the form of aerosol, vapour or liquid.

This oil, as with all other contaminants, can be transported by the air into the pneumatic circuit. It can then contact the seals of the components and subsequently pass into the environment through the outlets of the solenoid valves. In this case coalescing filters are used to aggregate those micro-molecules of oil suspended in the air and remove them.

The use of Camozzi coalescing filters enable to reach classes 2 and 1.

It is important to keep in mind that best performance is reached only by means of a multi-phase filtering process with subsequent phases.

As illustrated, different filters have different characteristics - a very efficient filter for a certain contaminant may not be so effective for other contaminants.

The filtering elements determine the class of the filters, these elements should be replaced after a specified period or after a specified number of working hours. These parameters vary according to the characteristics of the incoming air.

Camozzi filters are subdivided into different groups:

- Filtering element of 25 μm , class 7-8-4
- Filtering element of 5 μm , class 6-8-4
- Filtering element of 1 μm , class 2-8-2
with pre-filter class 6-8-4
- Filtering element of 0,01 μm , class 1-8-1
with pre-filter class 6-8-4 residual oil content of 0,01 mg/m³
- Activated carbon, class 1-7-1
with pre-filter class 1-8-1 residual oil content of 0,003 mg/m³

The components are factory greased with special products and do not need an additional lubrication. In case it should be necessary, use ISO VG 32 oil. The quantity of oil introduced into the circuit depends on the applications. Camozzi suggests a maximum dosage of three drops per minute.

Pneumatic cylinders

The choice of the correct cylinder mounting and also that of the rod attachment to any moving parts, are as important as the control of parameters relating to speed, mass and radial loads.

The control of these parameters has to be guaranteed by the user.

The location of position sensors (reed switches), and their switching response times to magnetic fields, is dependent upon the type and bore size of the cylinder and the appropriate precautions need to be taken when fixing these items. (see notes on the pages about sensors).

We do not advise the use of a cylinder as a shock absorber or for pneumatic cushioning. If used at the maximum speed, we recommend gradual deceleration to avoid a violent impact between piston and the cylinder end cover.

As a general value, we calculate a maximum average speed of 1 m/sec.

In this case no lubrication is required as the lubrication introduced during assembly is sufficient to guarantee good operation.

If faster speeds are required, we suggest lubrication in the quantities described above.

Directive ATEX 2014/34/EU: Products classified for the use in potentially explosive atmospheres



Since 19 April 2016 all products which are sold in the European Union and destined to be used in **potentially explosive atmospheres** have had to be approved according to new Directive 2014/34/EU, also known as ATEX. This Directive applies to both electrical and non-electric items, such as pneumatic drives.

Main changes introduced by Directive 2014/34/EU:

- Non-electric apparatus and devices, such as pneumatic cylinders, have to comply with the Directive.
- Equipment is classified into different categories, which identifies the potentially explosive zones in which they may be used.
- The products are identified with the CE mark Ex.
- The instructions for use and the declarations of conformity should be supplied with each product that is to be used in potentially explosive zones.
- The Directive applies to products intended to be used in zones that are potentially explosive due to the presence of dust as well as to zones where potentially explosive gases may be present.

A potentially explosive atmosphere could be composed of gas, mist, steam or dust, which may be present constantly, intermittently or created by processes conducted within the zone. An explosion can occur when there are one or more inflammable substances plus an ignition source present.

An ignition source could be:

- Electrical (electric arcs, induced current, heat generated by the Joule effect, i.e. heat created when an electric current flows through a resistance.)
- Mechanical (heat between surfaces caused by friction, sparks generated by the collision of metallic bodies, electrostatic discharges, adiabatic compression, i.e. compression of an atmosphere causing a temperature rise)
- Chemical (exothermic reactions between materials)
- Naked flames. The products which are subject to approval are those which, during their normal use or because of a malfunction, present one or more ignition sources within a potentially explosive atmosphere.

The manufacturer has to guarantee that the product conforms to the declarations and carries the appropriate markings. Moreover, the product should always be accompanied by the appropriate instructions.

The maker and/or user of the equipment should identify the risk zone(s), as defined by Directive 99/92/CE, in which the products are to be used and ensure all instructions are followed.

In the case where a product is made up of two or more components with different markings, the component which is classified in the lowest category defines the class to which the complete product belongs.

Example:
solenoid suitable for Category 3 marked ...
Ex - II 3 Ex...

and valve suitable for Category 2 ...
Ex - II 2 Ex...

The valve unit with solenoid can be used only in Category 3 or Zone 2/22.

Zones, groups and categories

In the places and for the types of equipment subject to Directive 99/92/CE, the user should identify the classification of the zones in relation to the danger of the creation of explosive atmospheres because of the presence of gas or dust.

Apparatus and equipment for the use in potentially explosive zones are divided in groups:

Group I > apparatus used in mines

Group II > apparatus used in installations above ground

Group I: Apparatus used in mines

CATEGORY M1
Functioning in explosive atmospheres

CATEGORY M2
Non-supplied equipment in explosive atmospheres

Group II: Apparatus for installations above ground

Product category	Gas	Dust
1	Zone 0	Zone 20
2	Zone 1	Zone 21
3	Zone 2	Zone 22

Classification of zones according to Directive 99/92/CE

- Category 1**
- Zone 0 - Area in which (permanently, for long periods or often) an explosive atmosphere is present, consisting of a mixture of air and inflammables in the form of gas, vapour or mist.
 - Zone 20 - Area in which (permanently, for long periods or often) an explosive atmosphere is present in the form of a dust/powder cloud which is combustible in air.
- Category 2**
- Zone 1 - Area in which, during normal activities, the formation of an explosive atmosphere is probable, consisting of a mixture of air and inflammables in the form of gas, vapour or mist.
 - Zone 21 - Area in which occasionally during normal activities the formation of an explosive atmosphere is probable, in the form of a dust cloud which is combustible in air.
- Category 3**
- Zone 2 - Area in which, during normal activities, the formation of an explosive atmosphere, consisting of a mixture of air and inflammables in the form of gas, vapour or mist is not probable and, whenever this should occur, it is only of a short duration.
 - Zone 22 - Area in which, during normal activities, the formation of an explosive atmosphere in the form of a combustible dust cloud is not probable and, whenever this should occur, it is only of a short duration.

Example of Marking:  II 2 GD c T100°C (T5) -20°C≤Ta≤60°C

II	II Group: Devices which are to be used in spaces exposed to risks of an explosive atmosphere, different from underground spaces, mines, tunnels, etc., classified according to the criteria in Annex I of the Directive 2014/34/EU (ATEX).
2	Category: Devices designed to function in compliance with the operational parameters determined by the manufacturer and guarantee a high protection level.
GD	Qualification gas and dusts: Protected against gas (G) and explosive dusts (D).
c	Non-electrical devices: Non-electrical devices for potentially explosive atmospheres. Protection through constructive security.
T 100°C	Max. temperature for components for dusts: Max. superf. temp. of 100°C regarding potential hazards resulting from striking within the vicinity of hazardous dusts.
T5	Max. temperature for components for gas: Max. superf. temp. of 100°C regarding potential hazards which may result from striking within gas environments.
Ta	Environmental temperature: -20°C≤Ta≤60°C. Environmental temperature range (with dry air)

Group I: Temperature classes

Temperature = 150°C or = 450°C according to the level of dust on the apparatus.

Group II: Temperature classes

Temp. classes for gas (G)	Admissible surface temperatures
T1	450°C
T2	300°C
T3	200°C
T4	135°C
T5	100°C
T6	85°C

ATEX certified Camozzi products
APPARATUS classified as ATEX Group II

Cylinders

Series	Category	Zone	Gas/Dust
16*	2 DE-3 SE	1/21 DE -2/22 SE	G/D
24*	2 DE-3 SE	1/21 DE-2/22SE	G/D
25*	2 DE-3 SE	1/21 DE-2/22SE	G/D
31-32	2 DE-3 SE	1/21DE-2/22SE	G/D
31-32 Tandem/multi-position	2 DE	1/21 DE	G/D
40*	2 DE	1/21 DE	G/D
41*	2 DE	1/21 DE	G/D
60*	2 DE-3 SE	1/21 DE-2/22 SE	G/D
61*	2 DE-3 SE	1/21 DE-2/22 SE	G/D
62*	2 DE	1/21 DE	G/D
63*	2 DE-3 SE	1/21 DE-2/22 SE	G/D
27	2 DE	1/21 DE	G/D
QP-QPR	2 DE-3 SE	1/21 DE-2/22 SE	G/D
QN	3 SE	2/22 SE	G/D
42	2 DE-3 SE	1/21 DE-2/22 SE	G/D
ARP	2	1/21	G/D
QCT-QCB-QXT-QXB	2	1/21	G/D

Proximity switches

Series	Category	Zone	Gas/Dust
CSH/CST/CSV	3	2/22	G/D
CSG	3	2/22	G/D

Valves

Series	Category	Zone	Gas/Dust
P	3	2/22	G/D
W	3	2/22	G/D
Y	3	2/22	G/D

Solenoids

Series	Category	Zone	Gas/Dust
U70	3	2/22	G/D
H80l**	2	1/21	G/D

Pressure switches

Series	Category	Zone	Gas/Dust
PM 11**	1	0/20	G/D

Freely installable COMPONENTS classified as ATEX Group II

Products	Category	Zone	Gas/Dust
Silencers	2	1/21	G/D
Quick release couplings	2	1/21	G/D
Manifolds	2	1/21	G/D
Sub-bases	2	1/21	G/D
Feet	2	1/21	G/D
Caps	2	1/21	G/D
Plates	2	1/21	G/D

Valves

Series	Category	Zone	Gas/Dust
9#*	2	1/21	G/D
A#	2	1/21	G/D
2	2	1/21	G/D
3#	2	1/21	G/D
4#	2	1/21	G/D
NA (NAMUR) #	2	1/21	G/D
E (pneumatic)	2	1/21	G/D

FRL

Series	Category	Zone	Gas/Dust
MC#	2	1/21	G/D
N	2	1/21	G/D
MX#	2	1/21	G/D
T	2	1/21	G/D
CLR	2	1/21	G/D
M	2	1/21	G/D
MD#	2	1/21	G/D

* According to ISO standard

** Products with ATEX and IECEx certification

Without solenoid

- » The order code number of the certified products is obtained by adding "EX" to the standard article number
 Es. 358-015 standard solenoid valve
 Es. 358-015EX ATEX certified solenoid valve

Accessories available in Category 2 Zone 1/21: couplings, junctions, brackets, piston rod nuts, nuts, counter brackets, bushings, pins, clevis pins, caps, gaskets, diaphragm, sub-bases, plates, feet, hand operated valves, flow valves, flanges, screw, tie rods, automatic and blocking valves, silencers and pressure gauge, connector kits, clamps, rapid and super rapid push-in fittings, hoses, sealing rings, locking nuts. Accessories available in Category 3, Zone 2/22: adaptors, slot covers, extensions, connectors. For more information on this kind of products see the website:

<http://catalogue.camozzi.com> within the section: Downloads > Certifications > ATEX Directive 2014/34/EU > List of products excluded from the directive 2014/34/EU ATEX.

Camozzi Returns Policy

Step by Step Guide

Step 1

If you have a product to be returned please call the Camozzi Sales office on 024 7637 4114.

Step 2

If the return is agreed you will be quoted a returns reference number, which must be noted on all paperwork relating to the returned goods.

Step 3

Address the parcel to
 Camozzi Automation Ltd,
 The Fluid Power Centre,
 Watling Street,
 Nuneaton,
 Warwickshire,
 CV11 6BQ.

Please do

- Include the returns note issued to you
- Ensure the goods are adequately packed to prevent damage in transit.
- Arrange for the parcel to be returned to Camozzi via the most appropriate method.
- Include a contact name on the enclosed paperwork in case of any queries.
- State the reason for return, a part number and description of the part or parts on the enclosed paperwork.

Please do not

- Return anything without a returns number (We reserve the right to return goods received without a returns number back to you at your cost)
- Give returns to the Camozzi Area Sales Managers, they are not permitted to accept returns.

Handling Charges

Handling charges will be applied to cover :-

- Administration
- Processing Cost
- Breakdown of product in to component parts (where applicable)

These handling charges will be advised when the returns number is issued.

Faulty Goods

If an item received is deemed faulty, we will invoice a replacement. This will be credited once the item has been returned, inspected and found to be faulty. If misuse has caused the item to fail then the replacement invoice will stand.

Contact

Camozzi Automation Ltd
The Fluid Power Centre
Watling Street
Nuneaton
Warwickshire
CV11 6BQ
United Kingdom
+44(0) 24 7637 4114
askus@camozzi.co.uk
www.camozzi.co.uk
store.camozzi.co.uk

